



US00D358361S

United States Patent [19]

[11] Patent Number: **Des. 358,361**

Lewis

[45] Date of Patent: **** May 16, 1995**

[54] **WET STORAGE BOAT HULL PROTECTOR**

5,117,764 6/1992 Kretzer, Jr. 114/361
5,291,848 3/1994 Wilhelm et al. 114/361

[76] Inventor: **Earl D. Lewis**, Rte. 1 Box 403,
Hampton, Tenn. 37658

Primary Examiner—Kay H. Chin
Attorney, Agent, or Firm—Hugh E. Smith

[**] Term: **14 Years**

[57] **CLAIM**

[21] Appl. No.: **22,142**

The ornamental design for a wet storage boat hull protector, as shown and described.

[22] Filed: **May 2, 1994**

[52] U.S. Cl. **D12/317**

[58] Field of Search D12/300, 317, 318;
114/361, 219, 56

DESCRIPTION

[56] **References Cited**

U.S. PATENT DOCUMENTS

3,220,026 11/1965 Lichti 114/219
4,753,184 6/1988 Schiavone 114/56
4,972,791 11/1990 Williams 114/219

FIG. 1 is a front elevational view of the wet storage boat hull protector showing my new design; FIG. 2 is a rear elevational view thereof; FIG. 3 is a left side elevational view thereof; FIG. 4 is a right side elevational view thereof; FIG. 5 is a top plan view thereof; FIG. 6 is a bottom plan view thereof; and, FIG. 7 is an isometric view thereof.

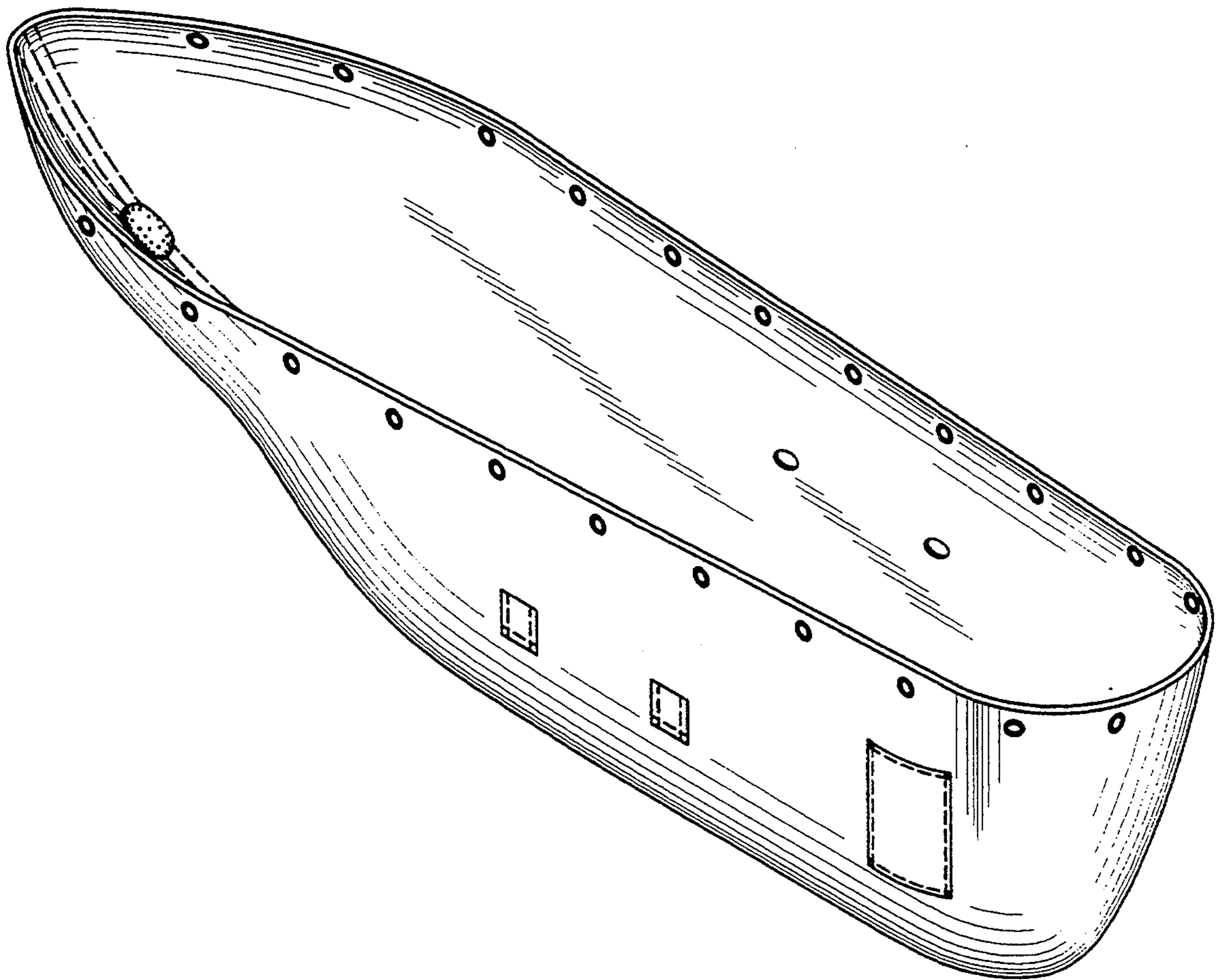

FIG. 1

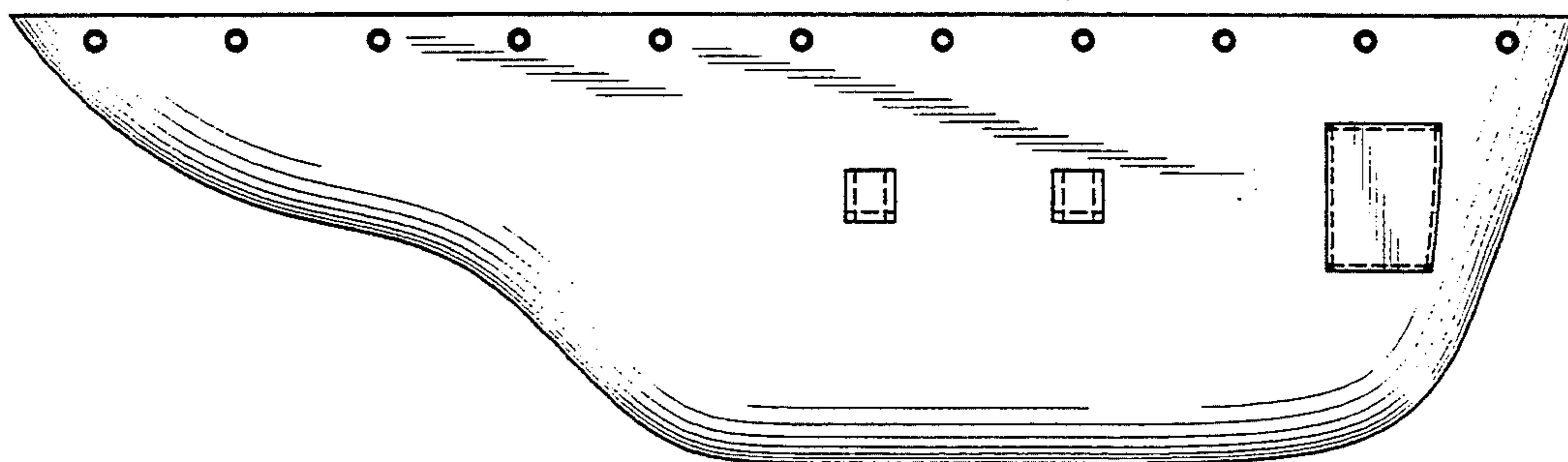

FIG. 2

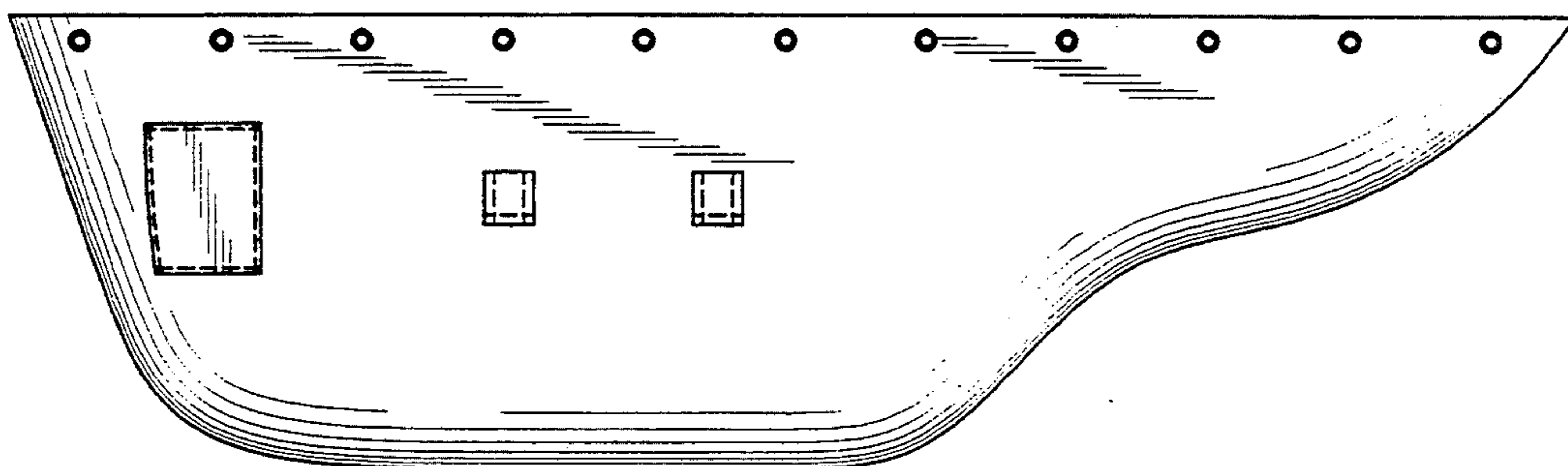

FIG. 3

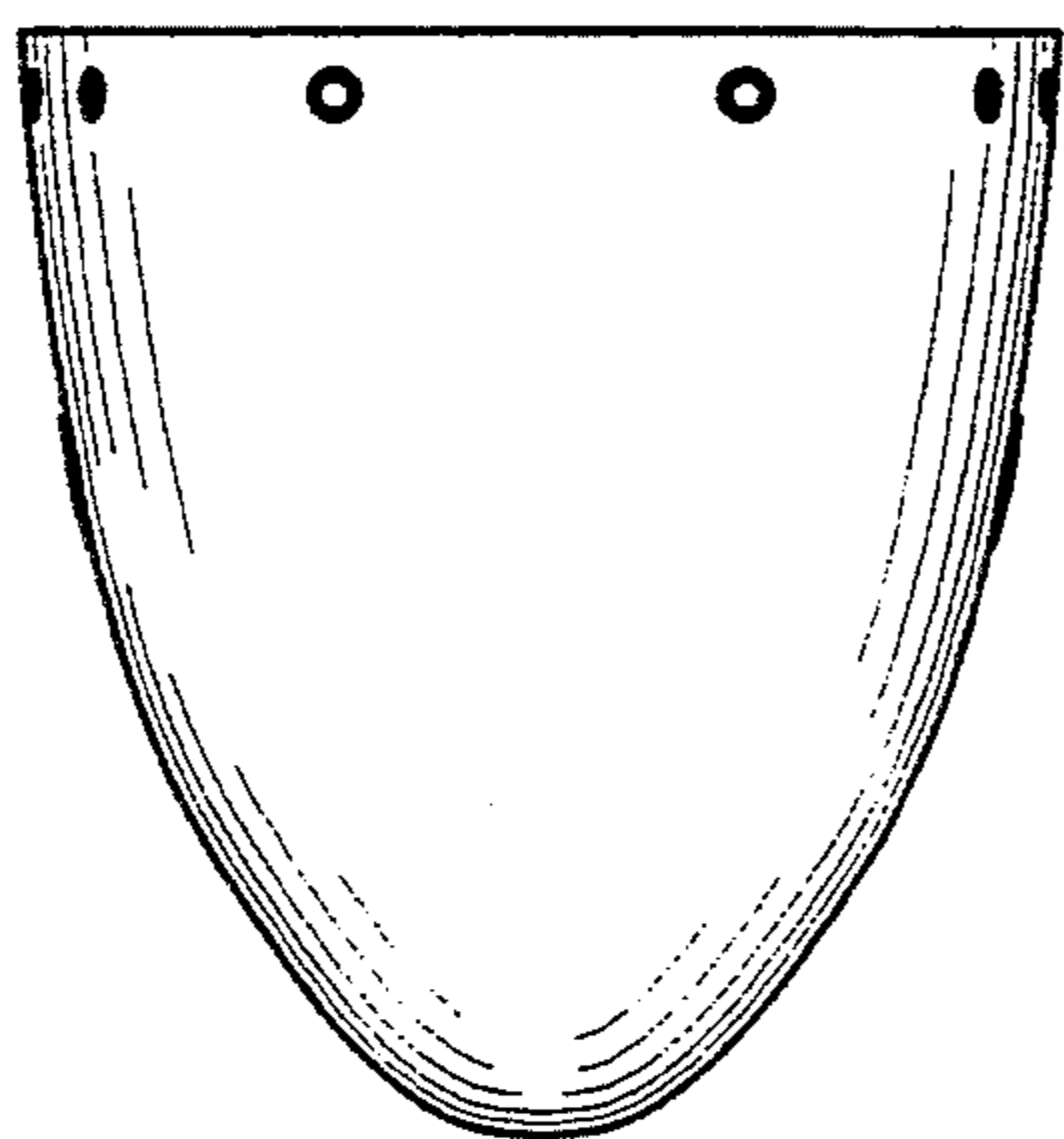

FIG. 4

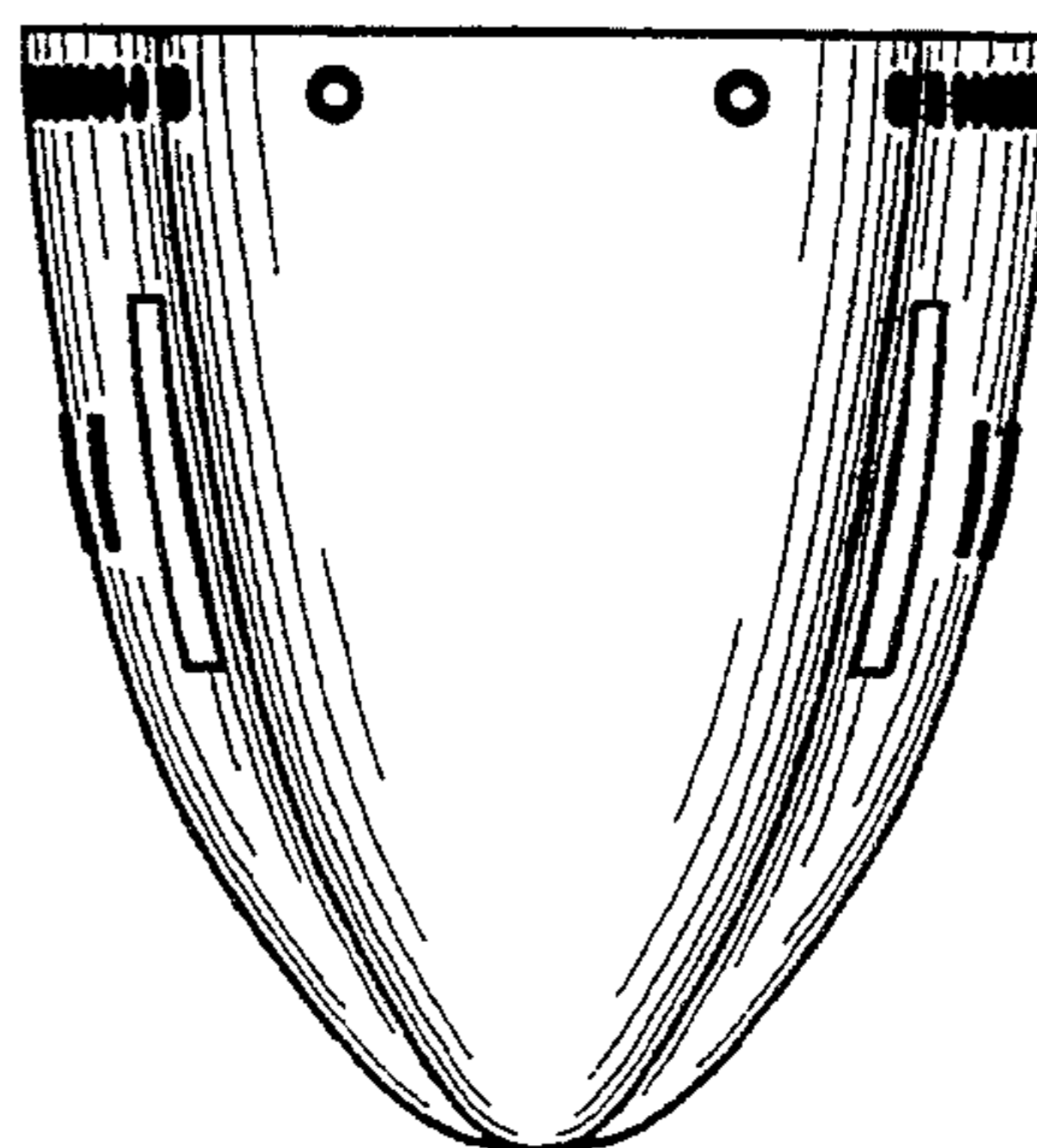

FIG. 5

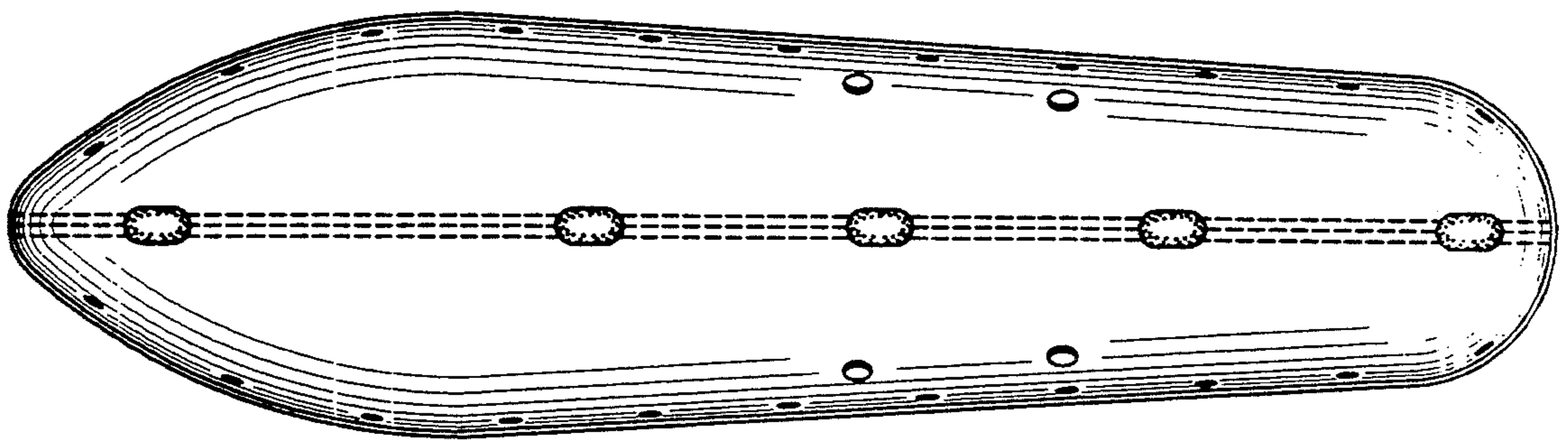

FIG. 6

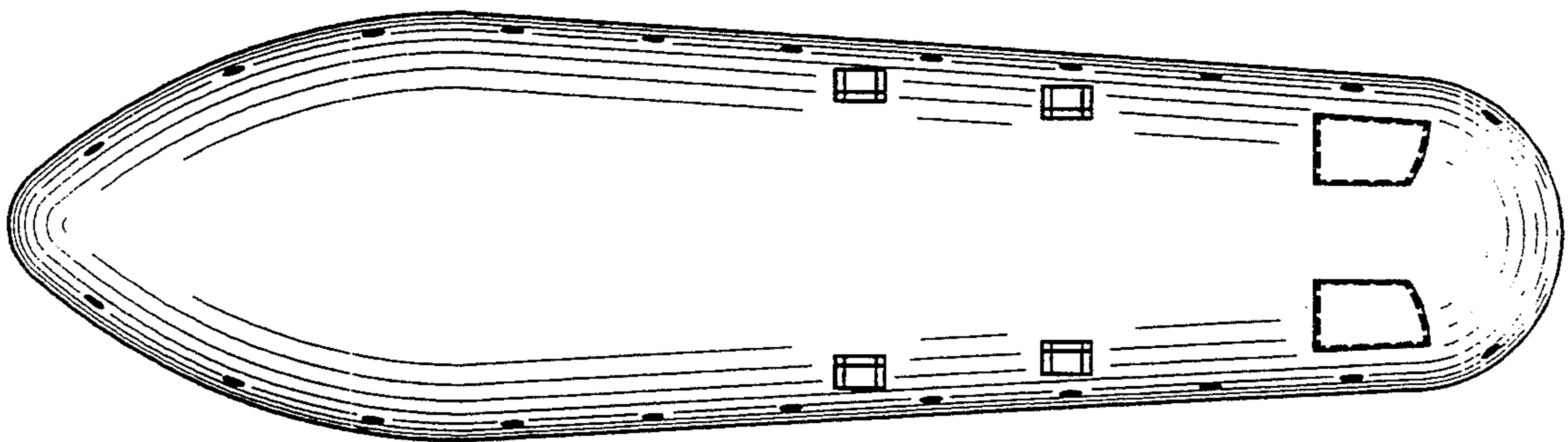

FIG. 7

