



US00D358316S

United States Patent [19]

[11] Patent Number: **Des. 358,316**

Markwart et al.

[45] Date of Patent: **** May 16, 1995**

[54] **SCREWDRIVER**

[76] Inventors: **Ronald Markwart; Leslie Markwart**, both of Box 84008, Burnaby, B. C., Canada, V5A 4T9

[**] Term: **14 Years**

[21] Appl. No.: **14,115**

[22] Filed: **Oct. 13, 1993**

[52] U.S. Cl. **D8/82; D8/82**

[58] Field of Search **D8/82, 83, 84, 85, 87, D8/107; 81/177.1, 177.85, 436, 489, 437, 441, 460; 16/110 R, 111 R; 7/165**

[56] **References Cited**

U.S. PATENT DOCUMENTS

D. 261,610	11/1981	Fee et al.	D8/85
D. 298,101	10/1988	Chen	D8/85
D. 328,699	8/1992	Shaanan et al.	D8/82
D. 340,633	10/1993	Badiali	D8/85
1,253,769	1/1918	Anderson	D8/87
3,006,395	10/1961	Dye	7/165
4,372,362	2/1983	Ahn	81/436
4,924,733	5/1990	McKenzie	81/439
5,228,363	7/1993	Corona et al.	81/439
5,265,504	11/1993	Fruhm	81/439

OTHER PUBLICATIONS

Jensen Tools Catalog, 1993, pp. 204, 205, 208 & 209, Screwdrivers.

Primary Examiner—Prabhakar G. Deshmukh
Assistant Examiner—Philip Hyder
Attorney, Agent, or Firm—Shlesinger Arkwright & Garvey

[57] **CLAIM**

The ornamental design for a screwdriver, as shown.

DESCRIPTION

FIG. 1 is a perspective view of the design;
 FIG. 2 is a top plan view thereof;
 FIG. 3 is a front elevation view of the design;
 FIG. 4 is a bottom plan view thereof;
 FIG. 5 is a rear elevation view thereof;
 FIG. 6 is a right side elevation view thereof;
 FIG. 7 is a left side elevation view thereof;
 FIG. 8 is a front elevation view of a modified embodiment of the design shown in FIGS. 1-7;
 FIG. 9 is a front elevation view of yet another modified embodiment of the design shown in FIGS. 1-7;
 FIG. 10 is a right side elevation view of the modified embodiment of FIG. 8;
 FIG. 11 is a left side elevation view of the modified embodiment of FIG. 8;
 FIG. 12 is a right side elevation view of the modified embodiment of FIG. 9;
 FIG. 13 is a left side elevation view of the modified embodiment of FIG. 10;
 FIG. 14 is a rear elevation view of the modified embodiment of FIG. 8; and,
 FIG. 15 is a rear elevation view of the modified embodiment of FIG. 9.

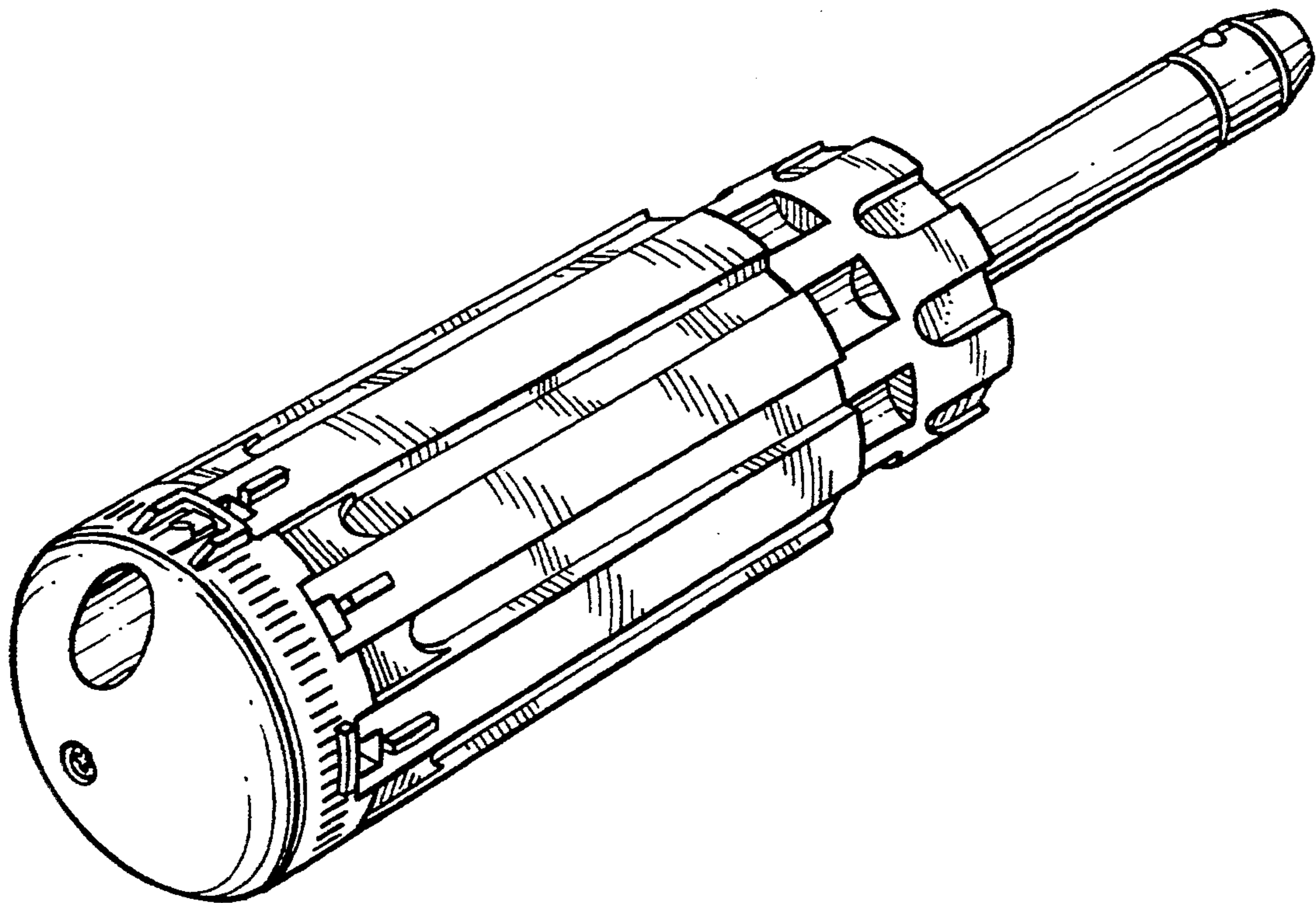

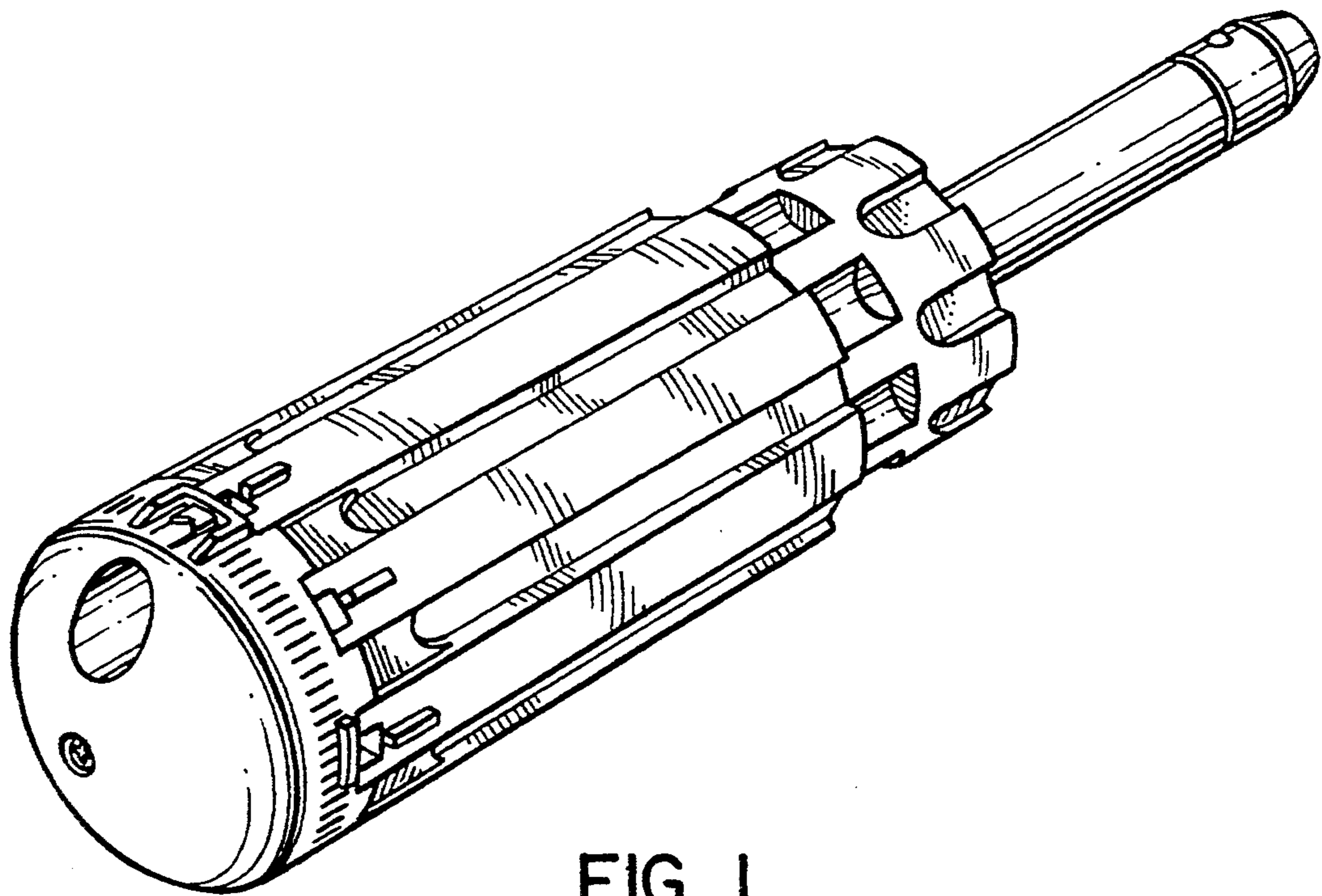

FIG. 1

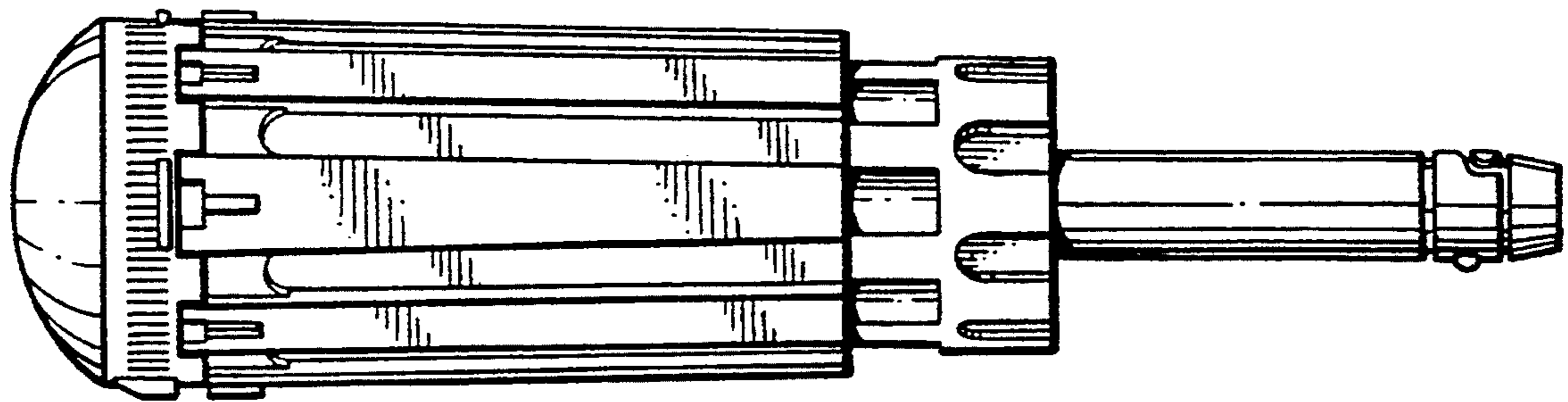

FIG. 2

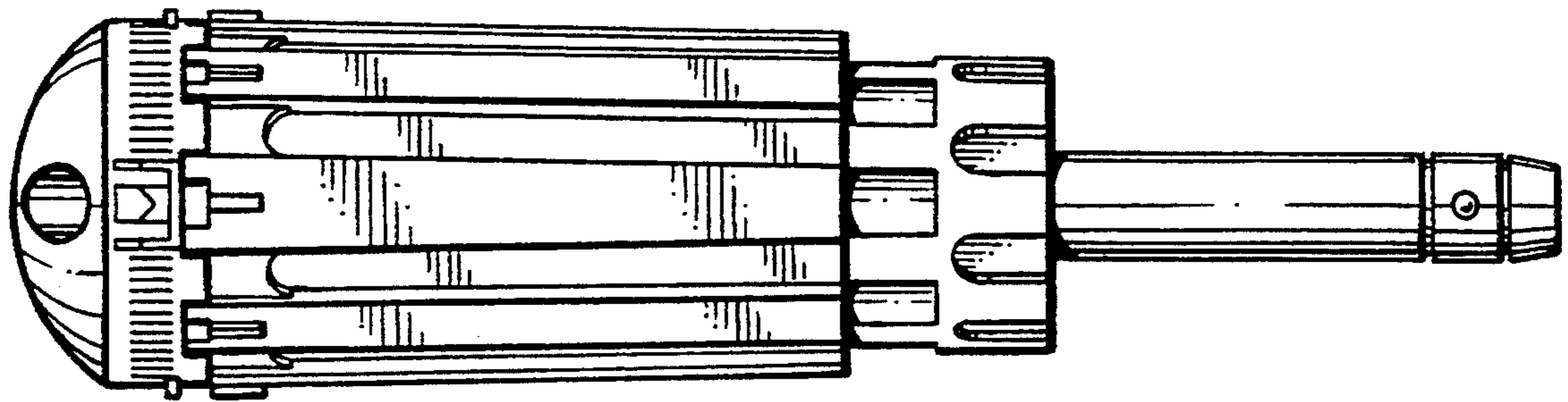

FIG. 3

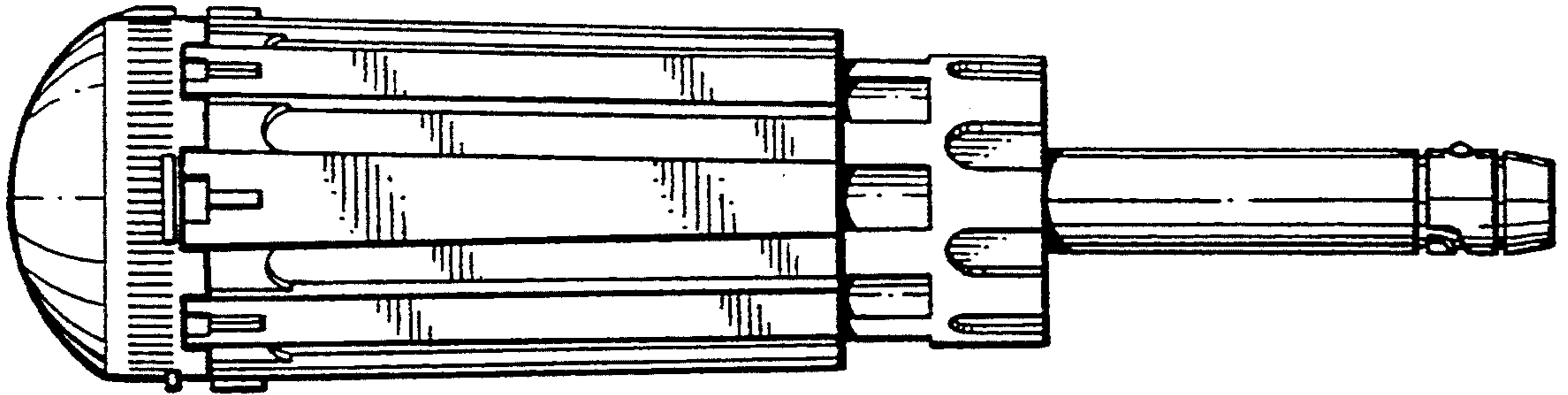

FIG. 4

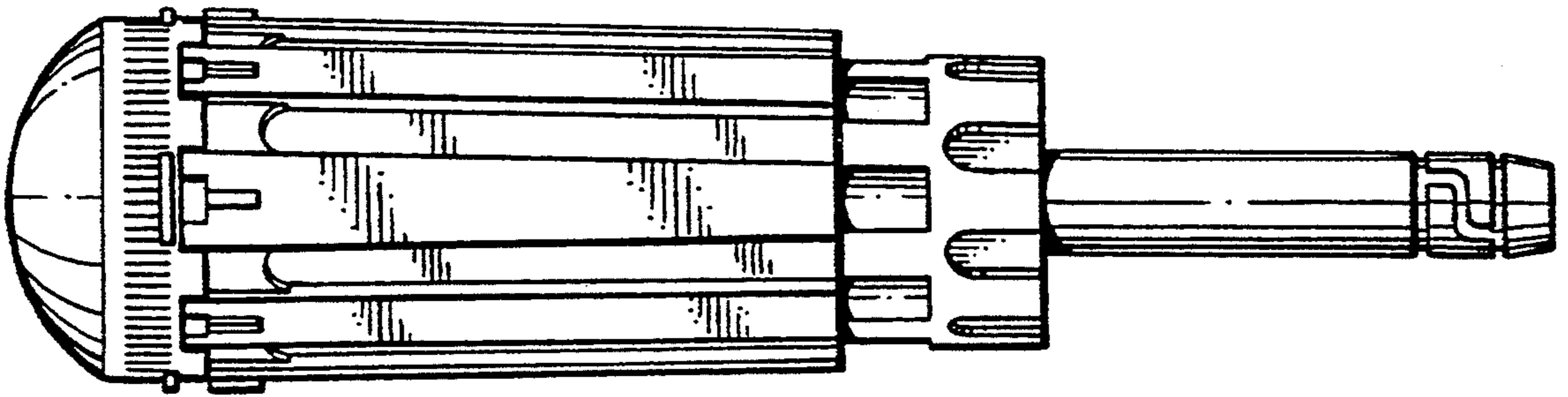

FIG. 5

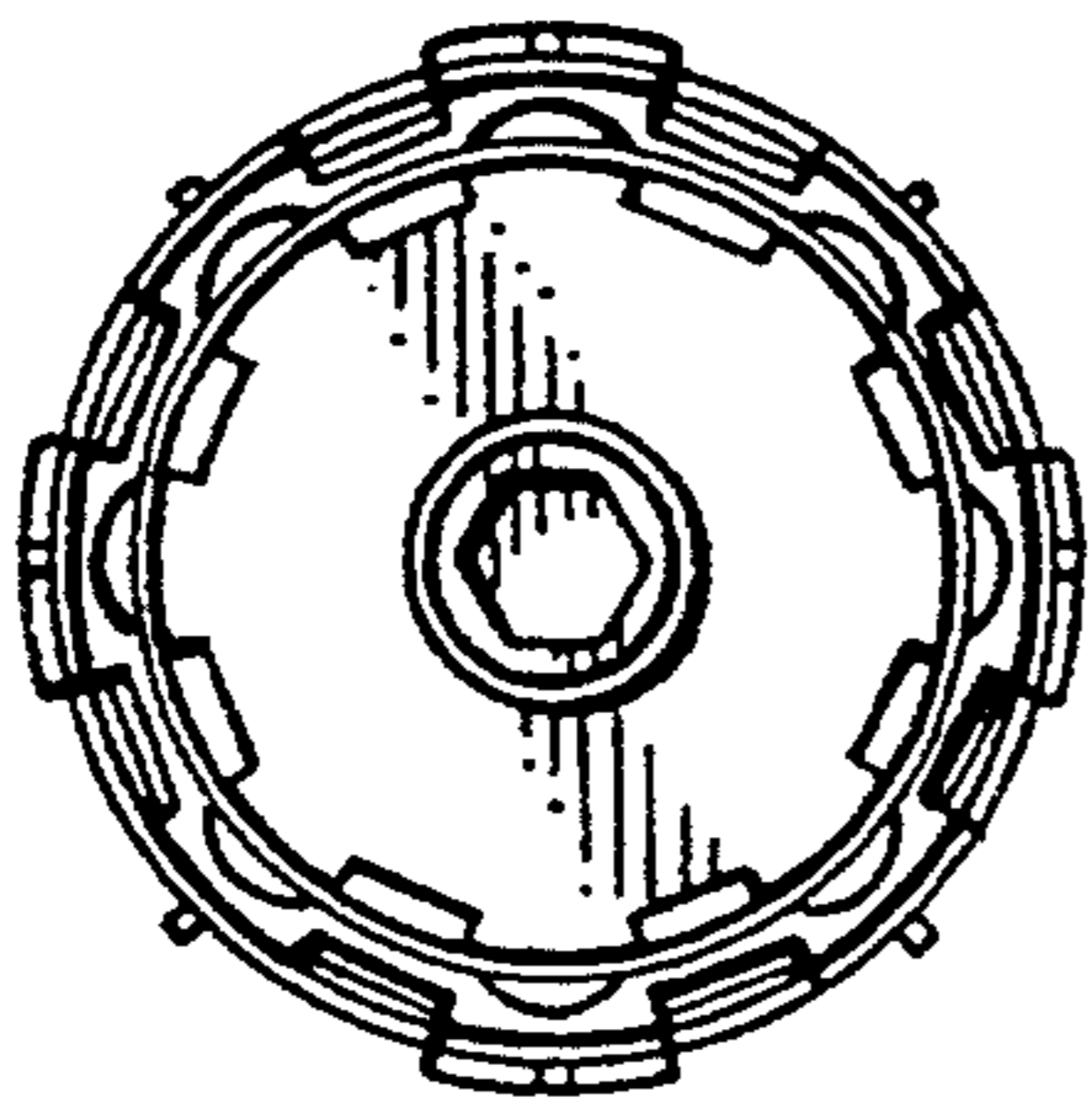

FIG. 6

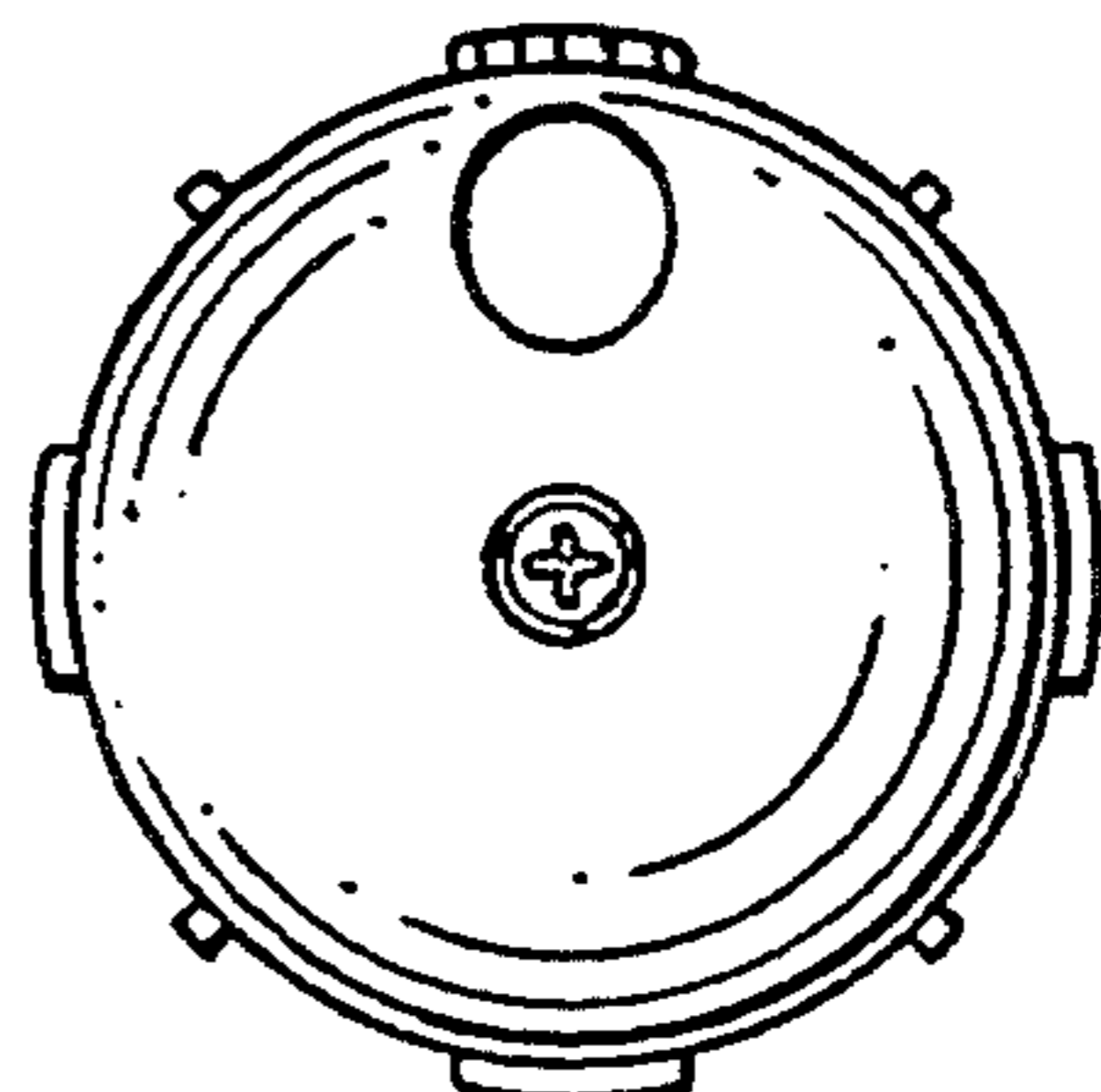

FIG. 7

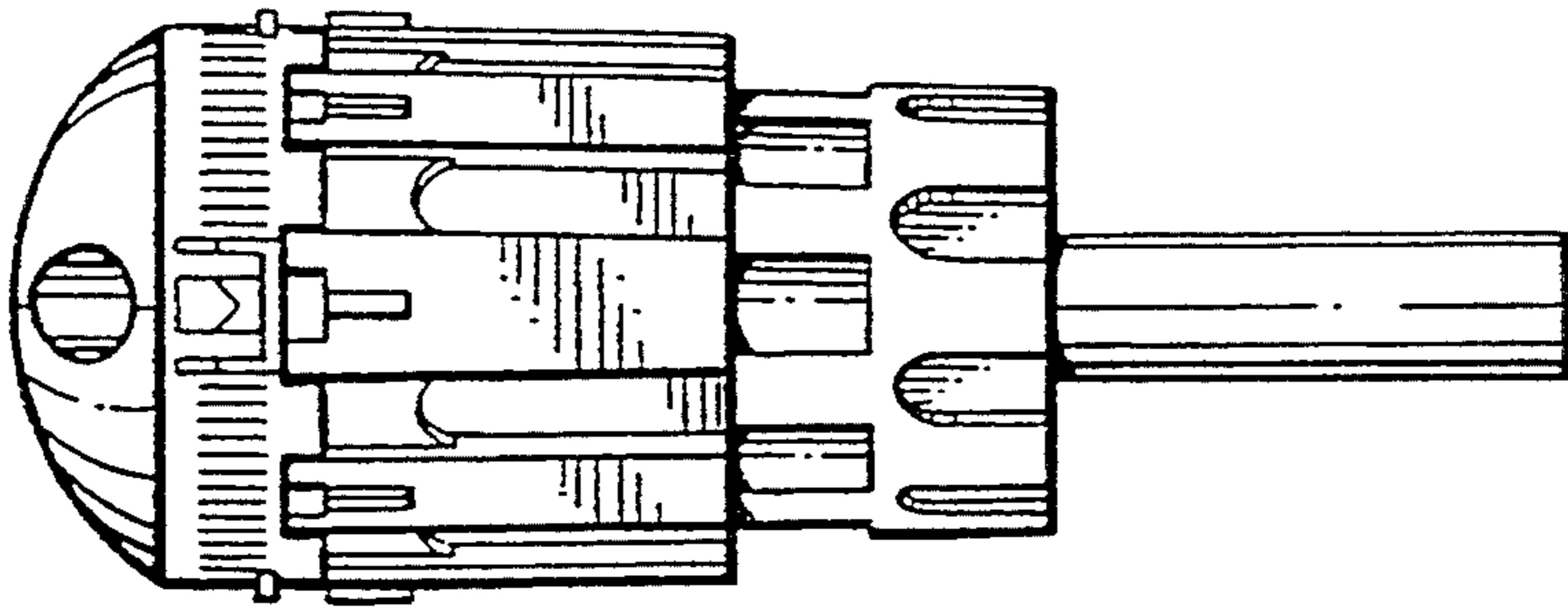

FIG. 8

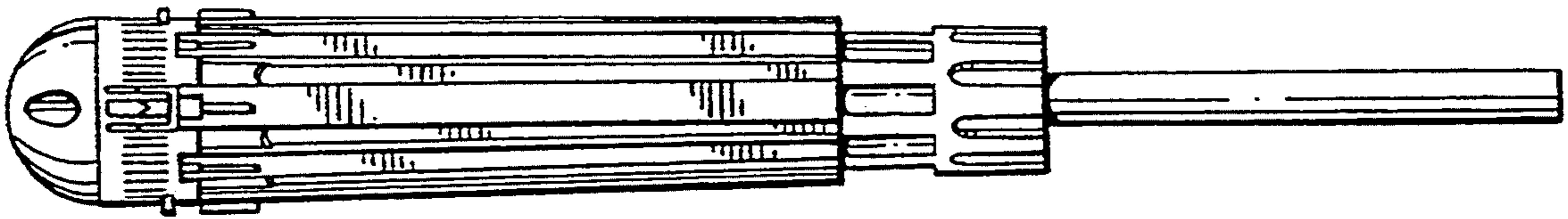

FIG. 9

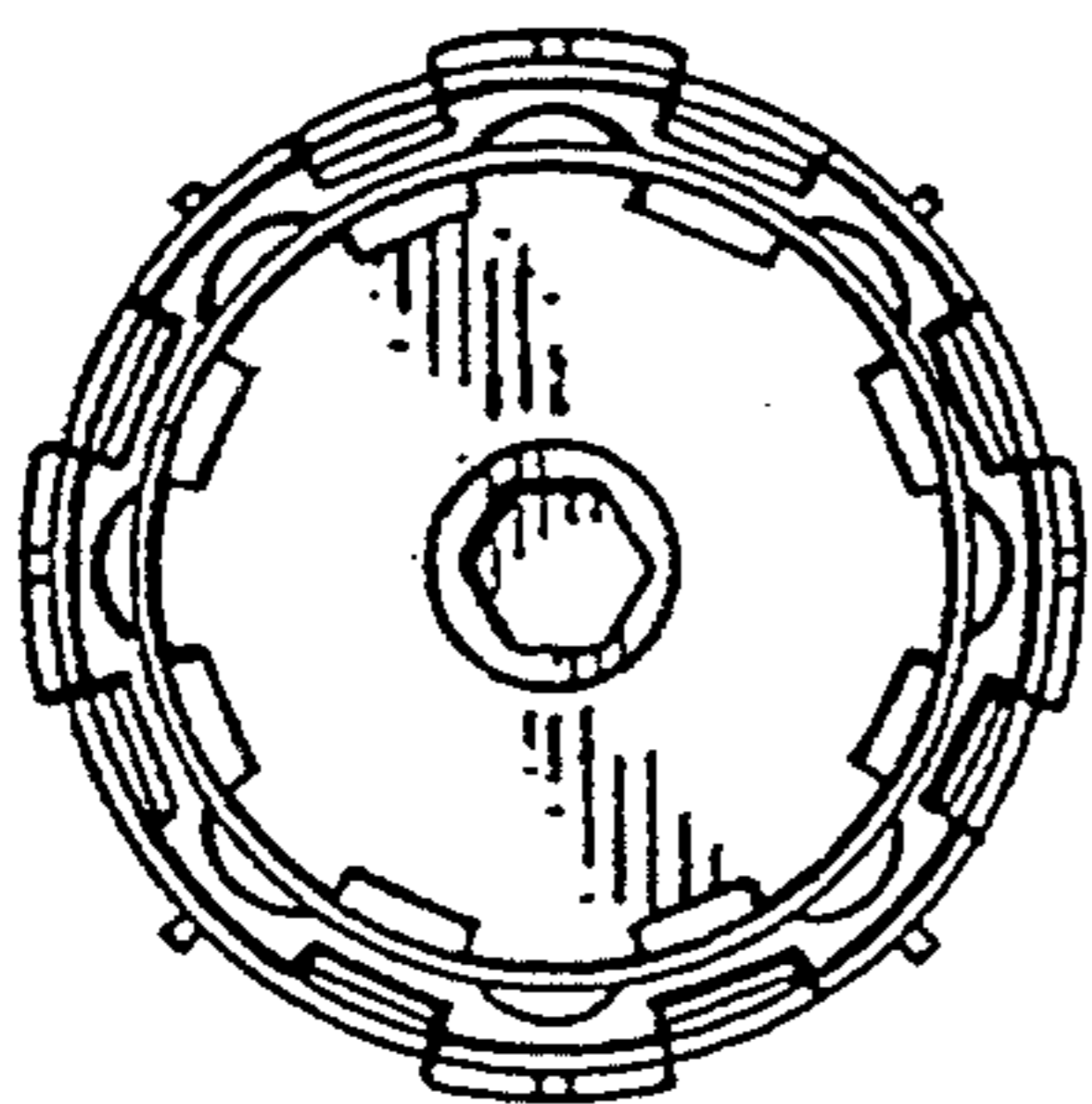

FIG. 10

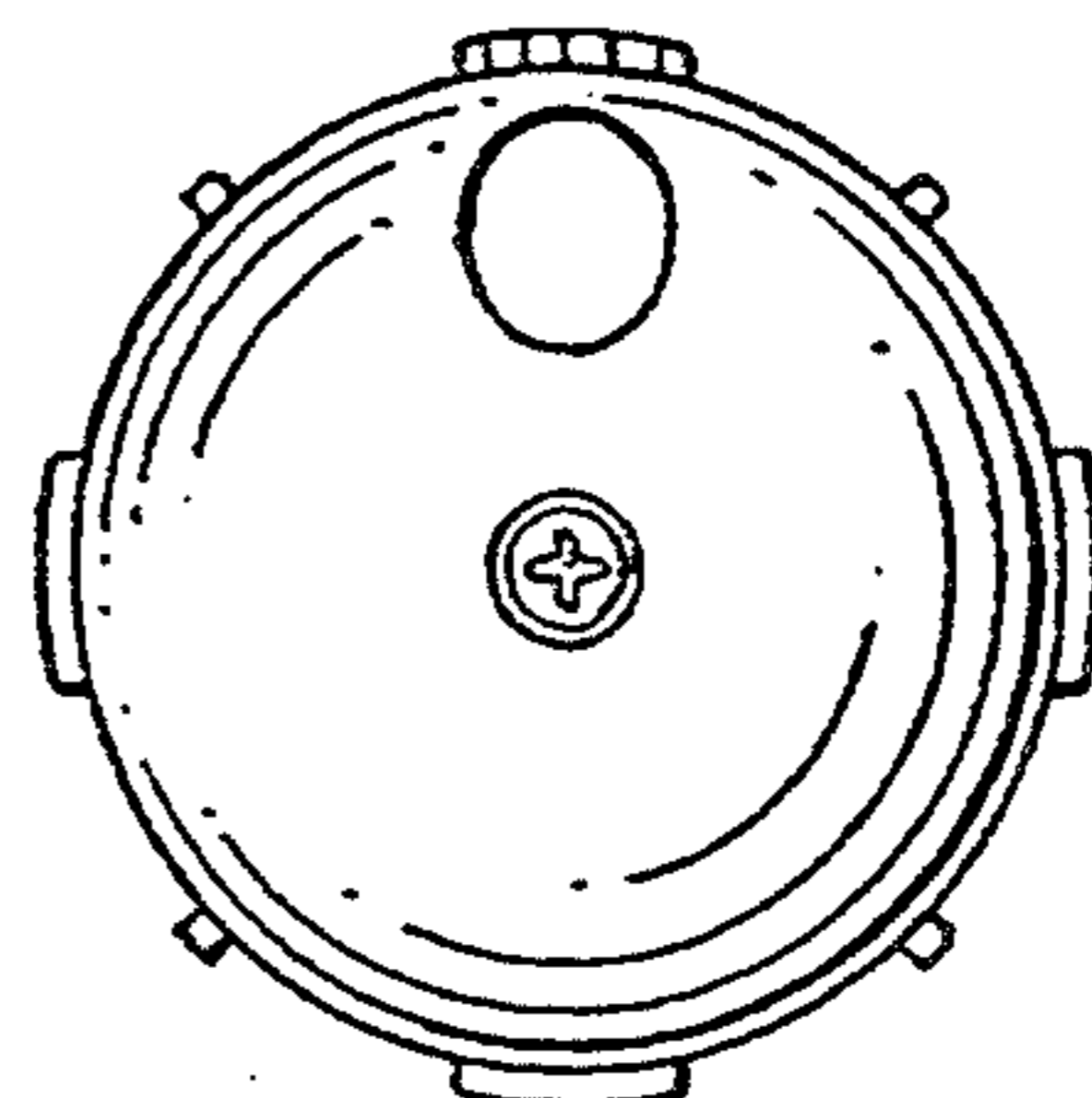

FIG. 11

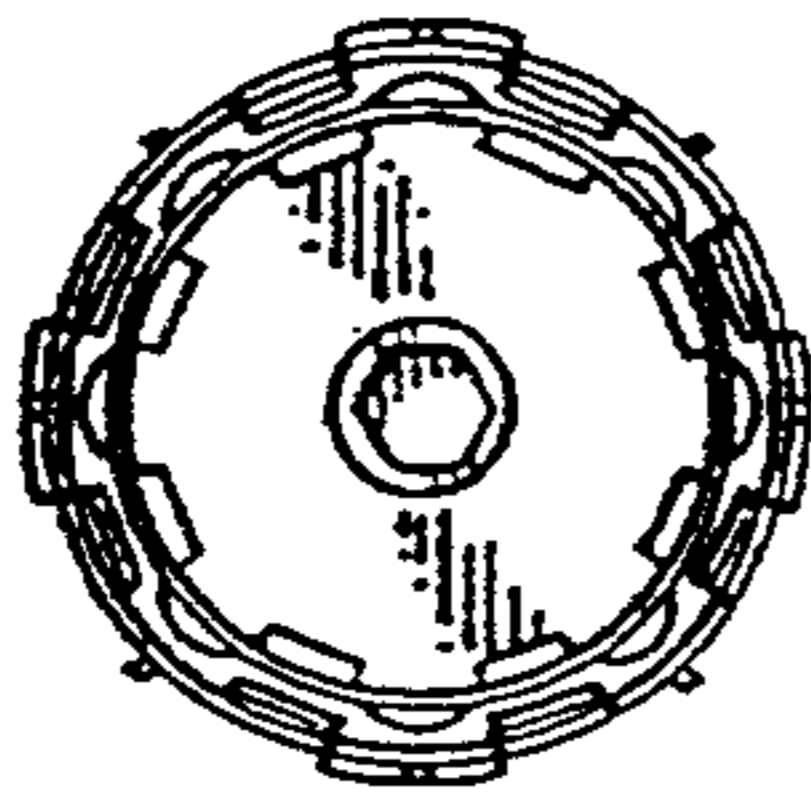

FIG. 12

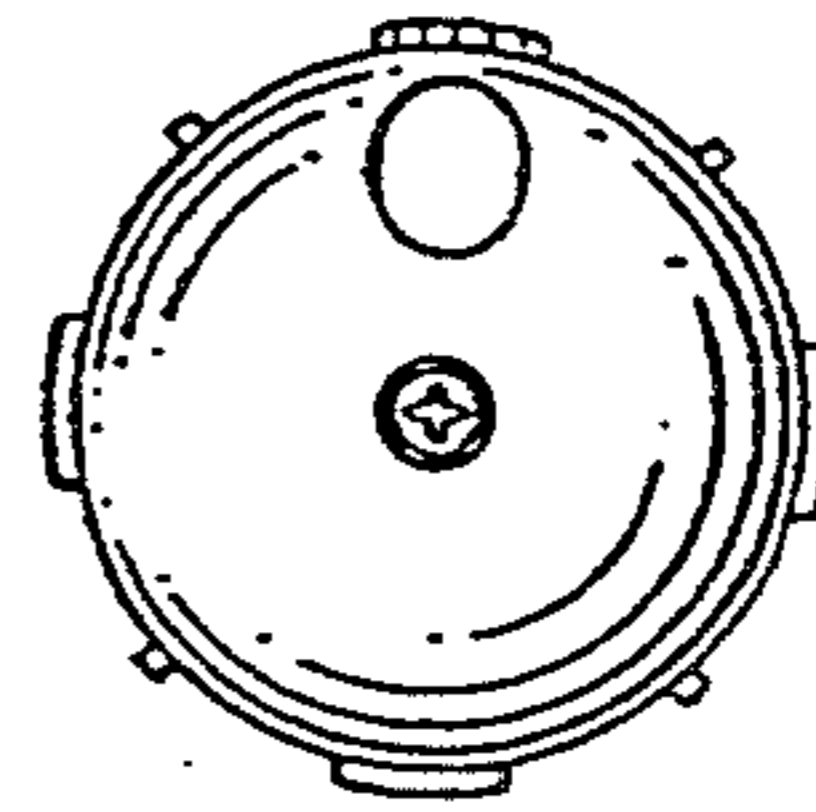

FIG. 13

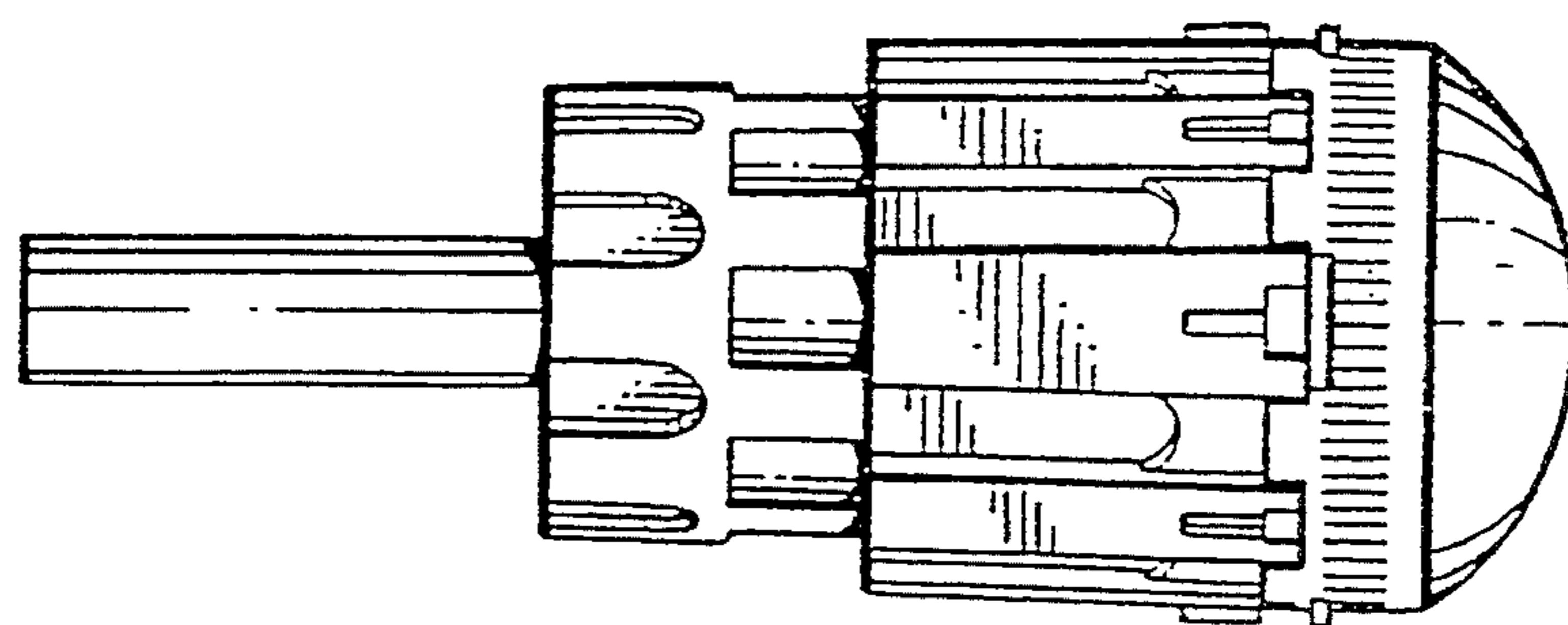

FIG. 14

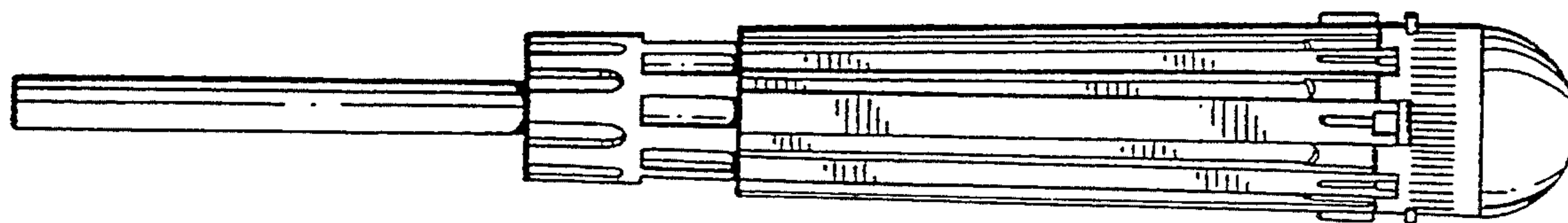

FIG. 15