



US00D358281S

United States Patent [19]

[11] Patent Number: **Des. 358,281**

Moher et al.

[45] Date of Patent: ** May 16, 1995

[54] DISPLAY RACK FOR TABLEWARE

[75] Inventors: **Robert Moher, Oneida, N.Y.; Thomas J. Nook, Grand Haven, Mich.**

[73] Assignee: **Oneida Ltd., Oneida, N.Y.**

[**] Term: **14 Years**

[21] Appl. No.: **19,983**

[22] Filed: **Mar. 16, 1994**

[52] U.S. Cl. **D6/471**

[58] Field of Search **D6/449, 450, 451, 453, D6/470, 471, 472, 476; 211/72, 74; 312/114, 116, 117, 120, 123**

[56] References Cited

U.S. PATENT DOCUMENTS

D. 175,107	7/1955	Gordon	D6/453
845,728	2/1907	Dickinson	312/120
1,401,825	12/1921	Squire	312/120
1,709,080	4/1929	Krueger	312/117
3,892,450	7/1975	Kolster et al.	312/117
4,164,287	8/1979	Muller et al.	248/174 X
4,383,722	5/1983	Weber	312/120 X

OTHER PUBLICATIONS

Bravo Furniture Ads, #2005.

Primary Examiner—Alan P. Douglas

Assistant Examiner—S. Snapp

Attorney, Agent, or Firm—Harris Beach & Wilcox

[57] CLAIM

The ornamental design for a display rack for tableware, as shown and described.

DESCRIPTION

FIG. 1 is a perspective view of a display rack for tableware illustrating my new design;

FIG. 2 is a front view of the rack of FIG. 1;

FIG. 3 is a right side view of the rack of FIG. 1;

FIG. 4 is a left side view of the rack of FIG. 1;

FIG. 5 is a top view of the rack of FIG. 1;

FIG. 6 is a back view of the rack of FIG. 1;

FIG. 7 is a bottom view of the rack of FIG. 1;

FIG. 8 is a fragmentary view of an alternate embodiment of the rack of FIG. 1;

FIG. 9 is a front view of the rack of FIG. 1 with the front panels retracted, showing the interior storage areas;

FIG. 10 is a cross sectional view of the rack of FIG. 1 taken along plane 10—10 of FIG. 9 the broken away portion of the Figure being for convenience of illustration only.

The broken lines in FIGS. 1, 8 and 9 are for illustrative purposes only and do not form part of the claimed invention.

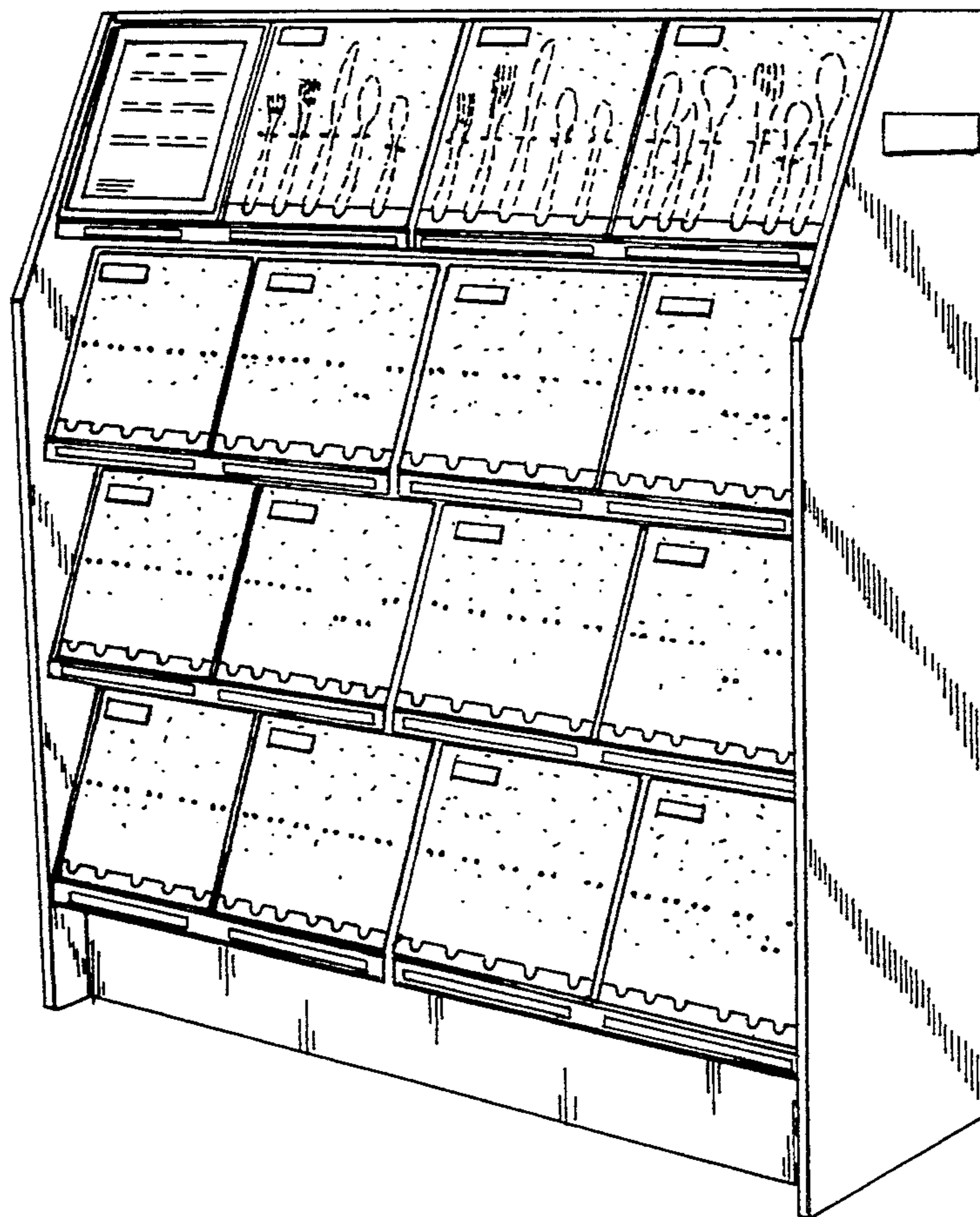

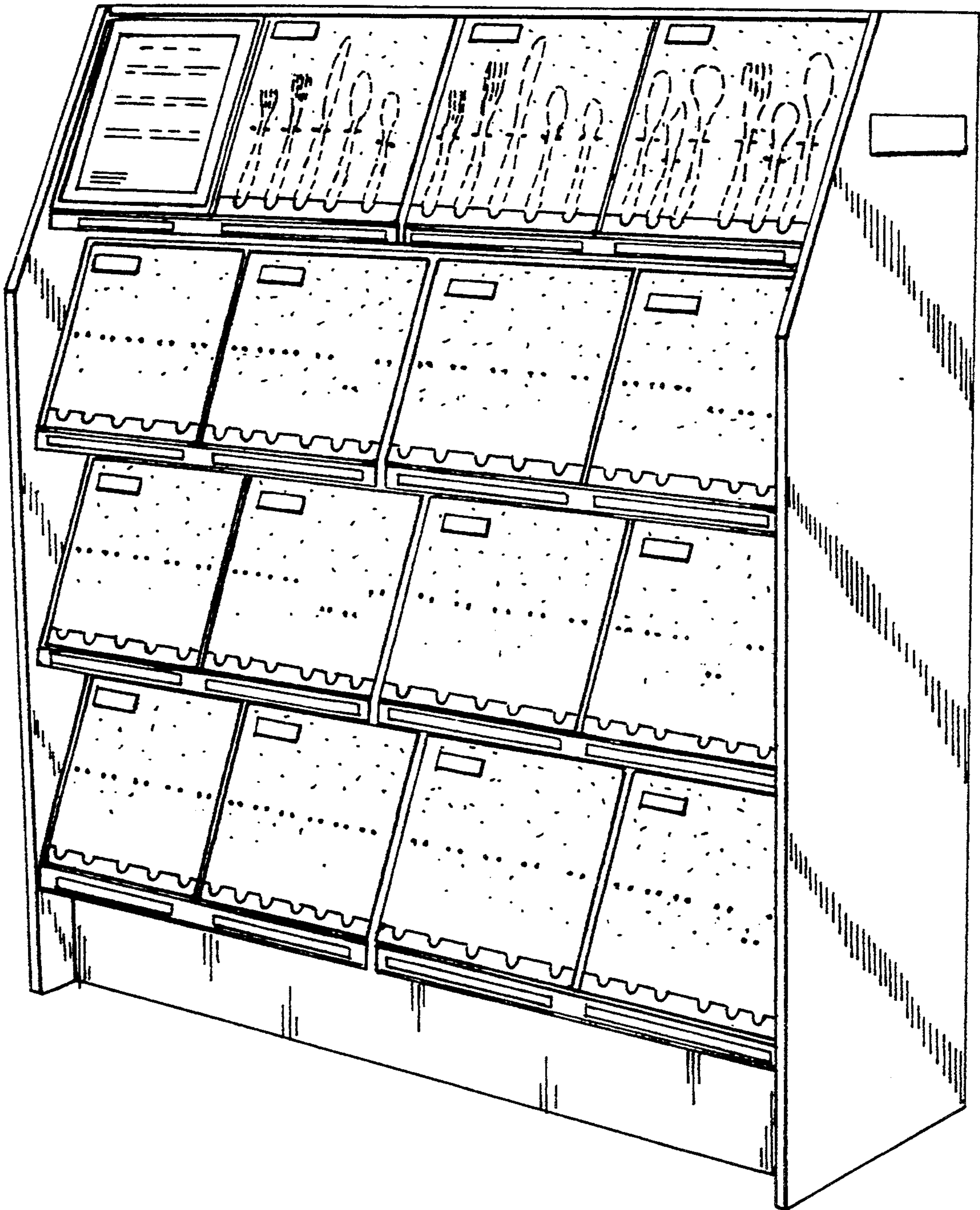

FIG. 1

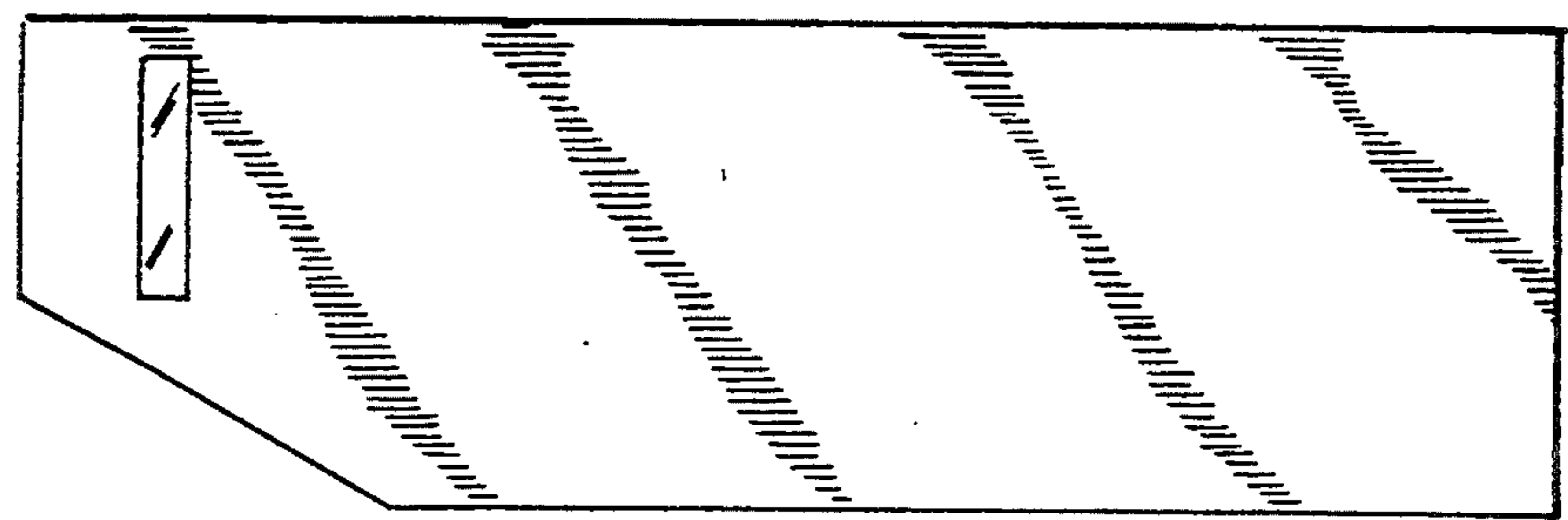

FIG. 4

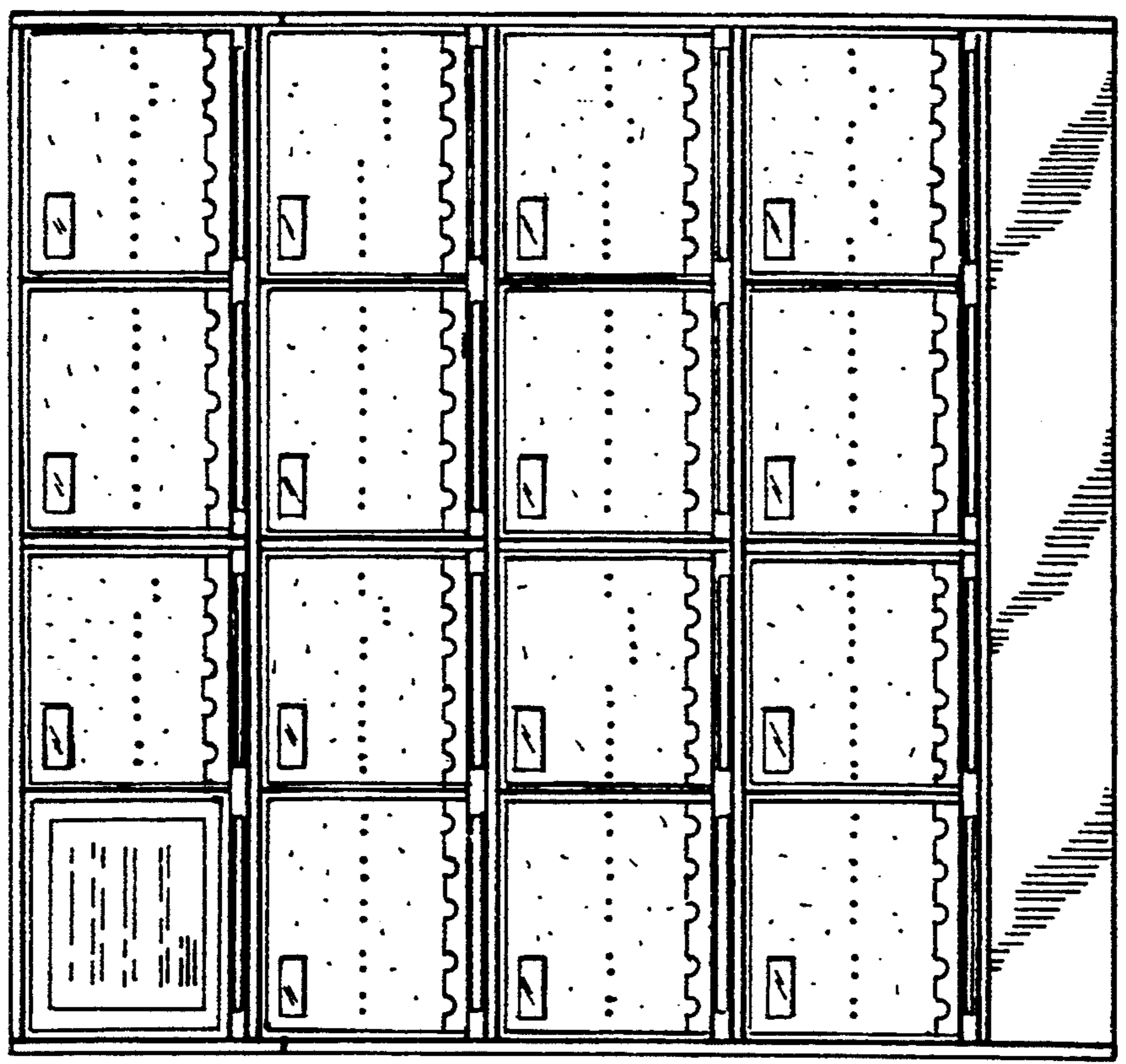

FIG. 2

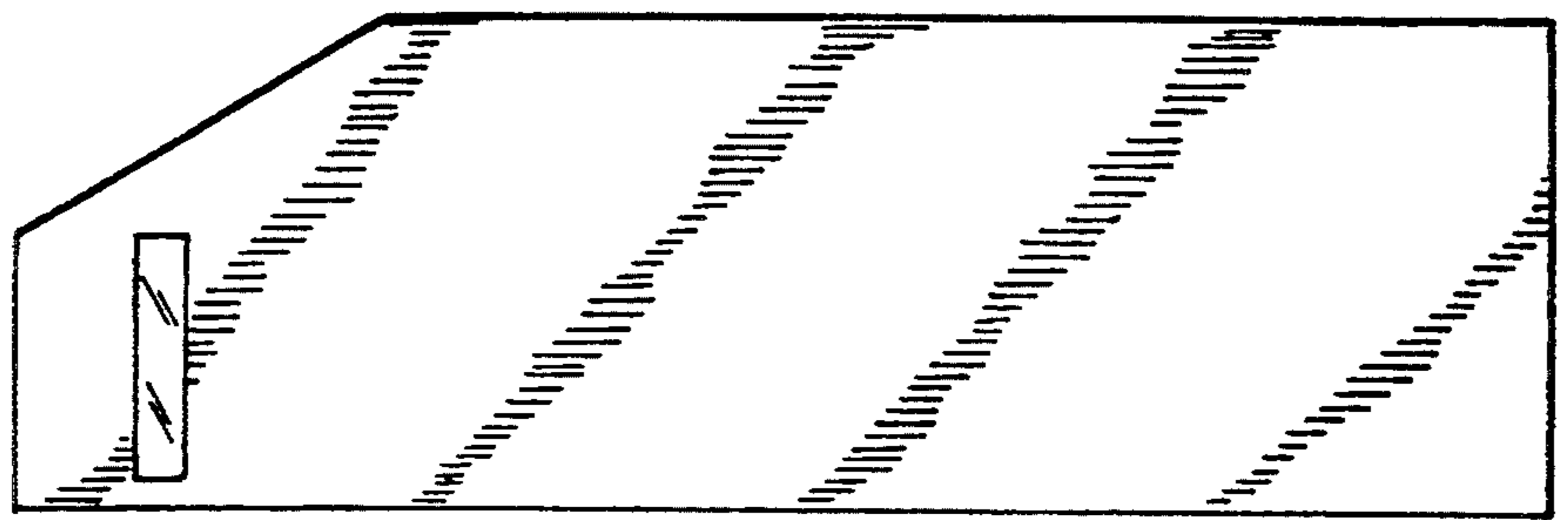

FIG. 3

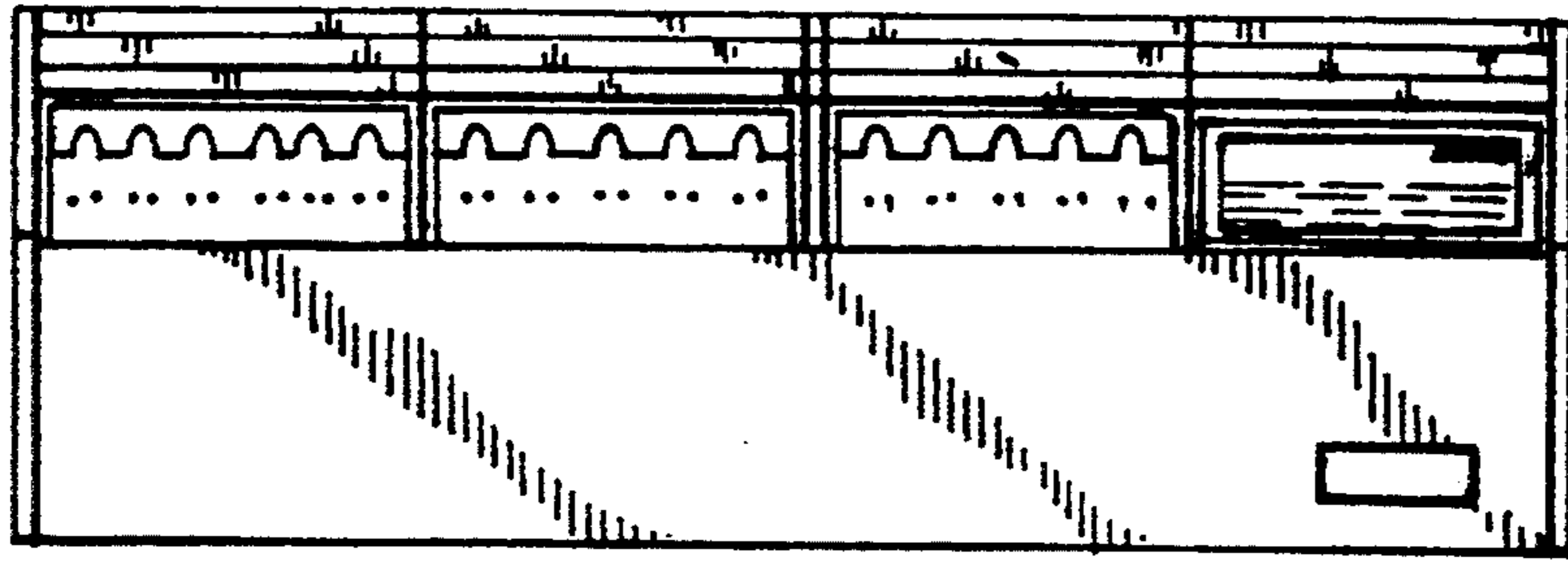

FIG. 5

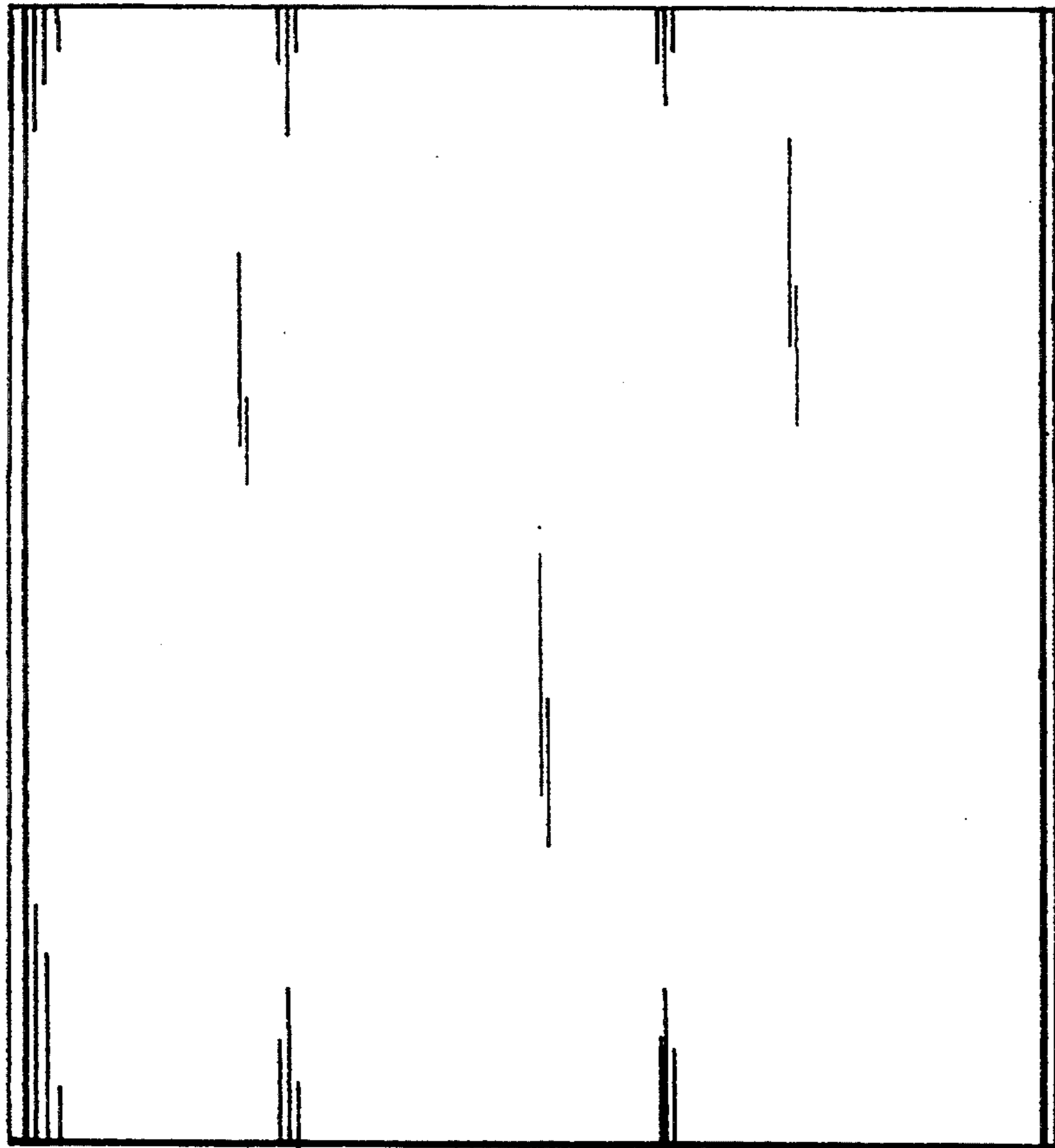

FIG. 6

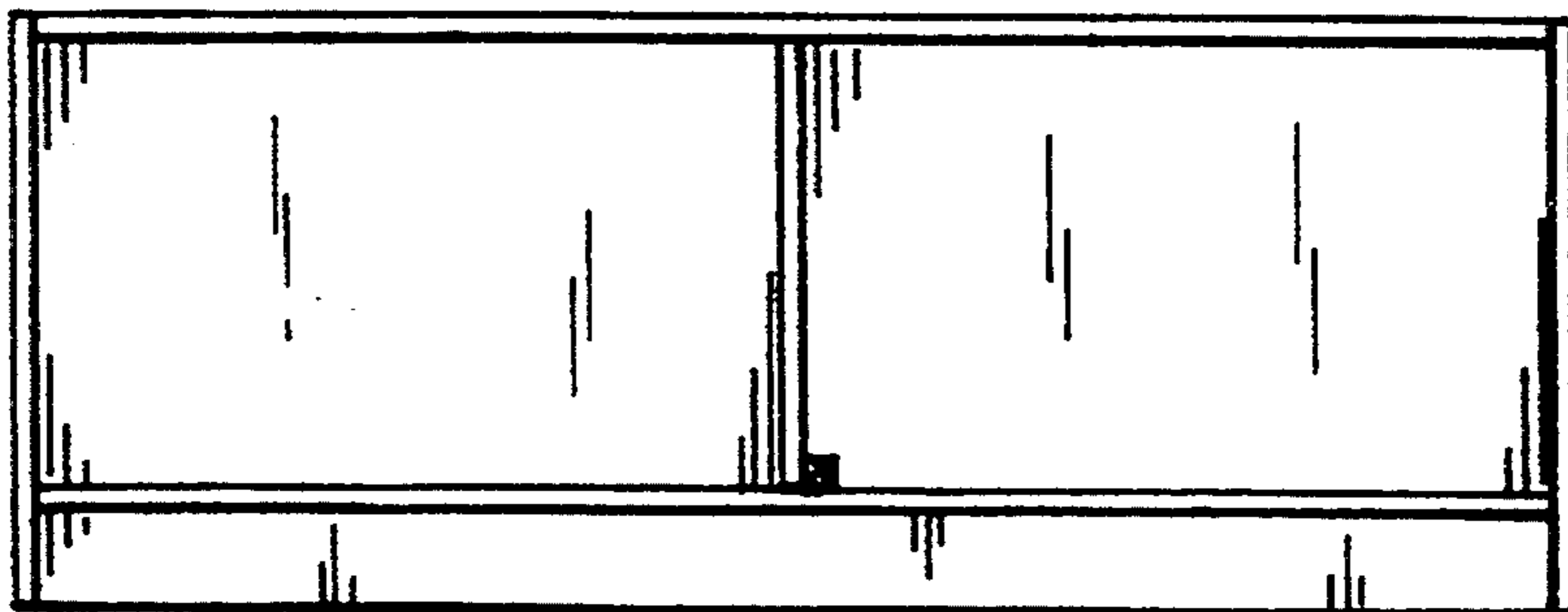

FIG. 7

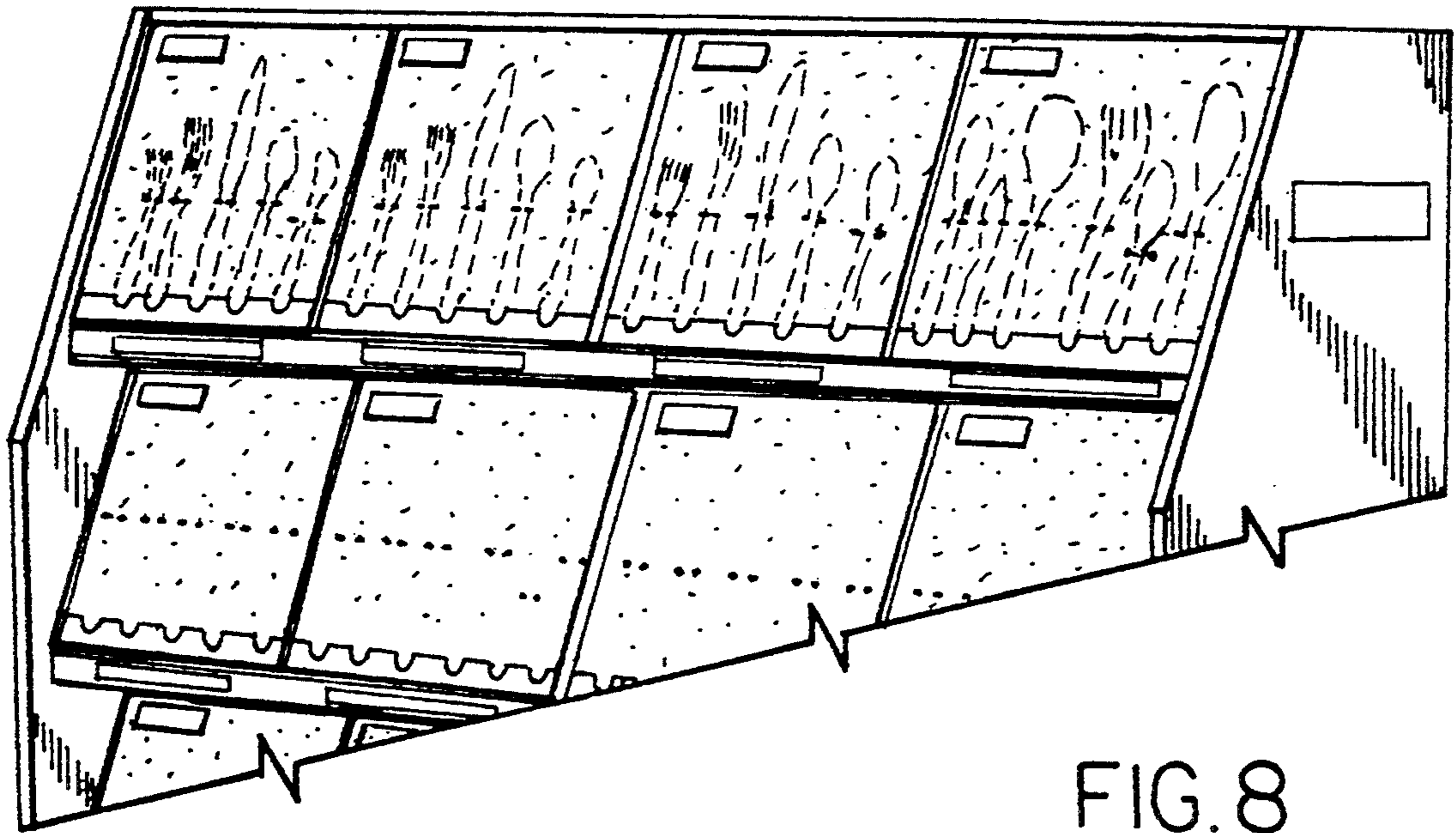

FIG. 8

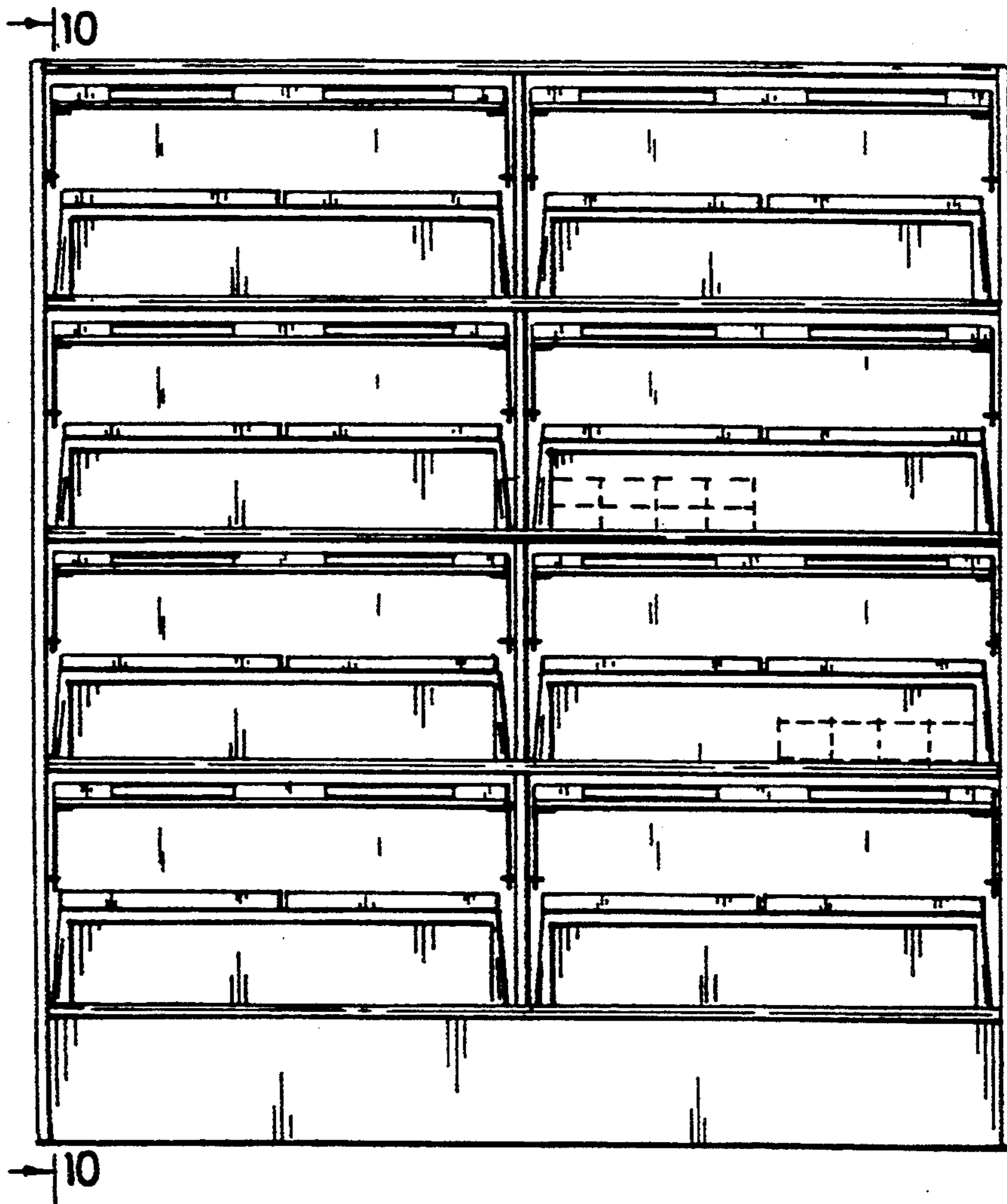

FIG. 9

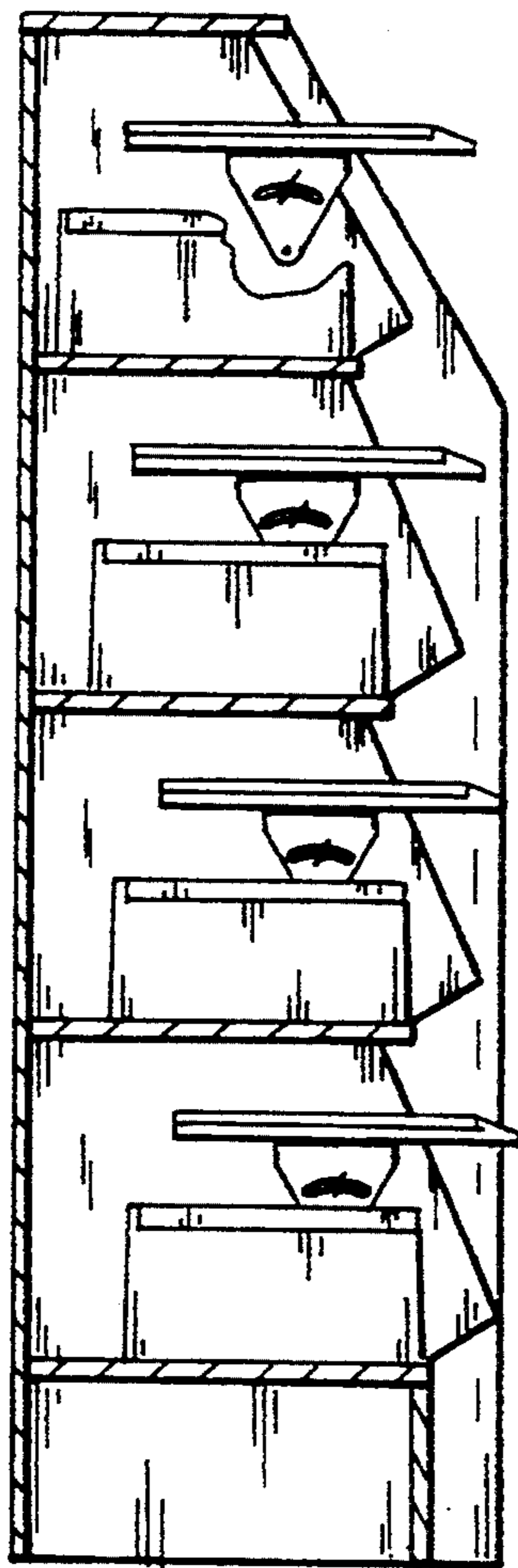

FIG. 10

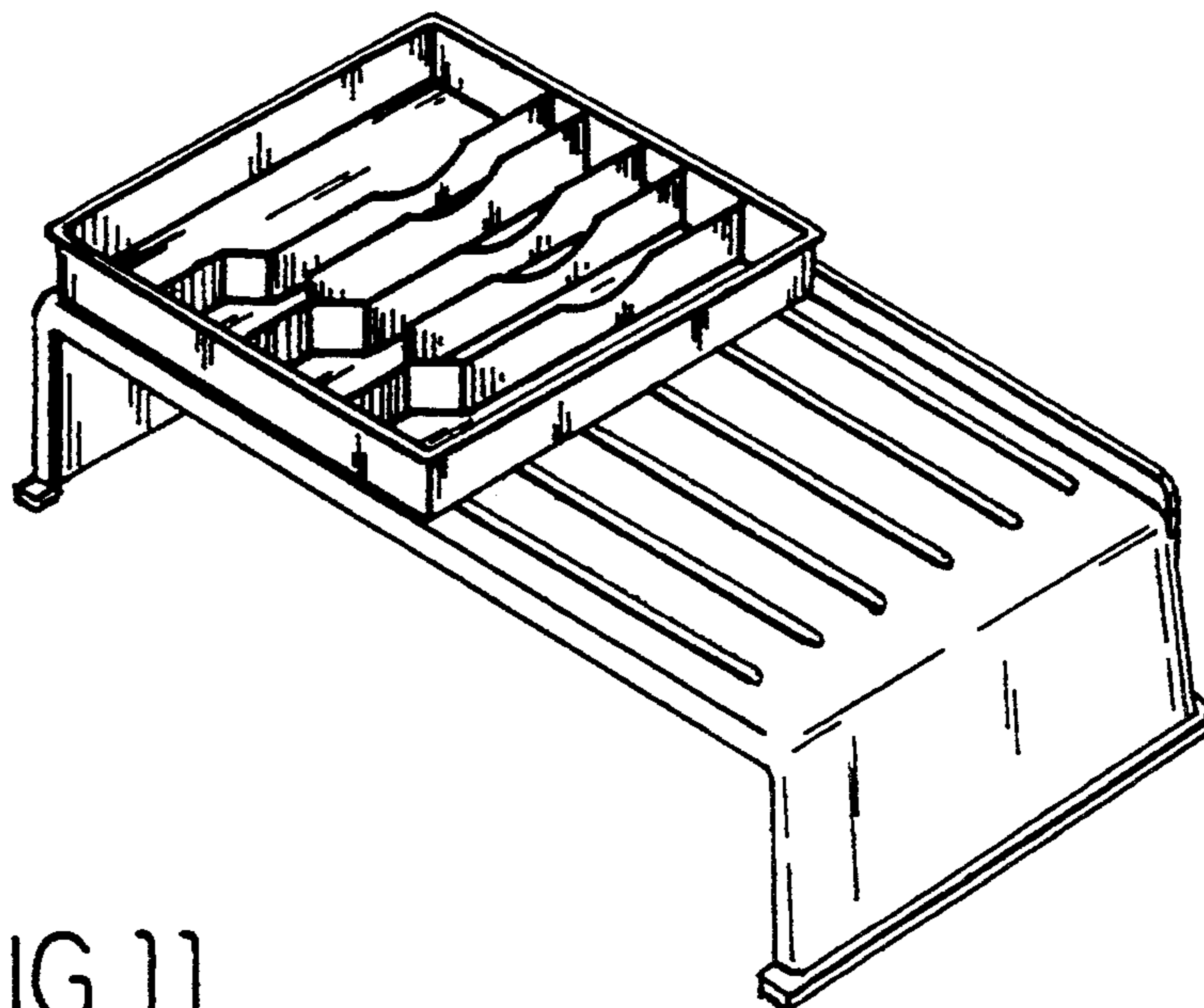

FIG. 11