



US00D358125S

# United States Patent [19]

[11] Patent Number: **Des. 358,125**

Jackson

[45] Date of Patent: **\*\* May 9, 1995**

[54] **MINI VAN STORAGE UNIT**

[76] Inventor: **Claude T. Jackson**, P.O. Box 1597,  
Henderson, N.C. 27536

[\*\*] Term: **14 Years**

[21] Appl. No.: **4,656**

[22] Filed: **Feb. 10, 1993**

[52] U.S. Cl. .... **D12/425**

[58] Field of Search ..... D12/155, 157; D3/40;  
D9/456; D34/40; D6/510; 296/37.1, 37.6,  
37.8, 37.15, 37.16; 224/273, 279, 42.42

[56] **References Cited**

**U.S. PATENT DOCUMENTS**

4,226,348	10/1980	Dottor et al.	224/42.42
5,025,964	6/1991	Phirippidis	296/37.1
5,054,668	10/1991	Ricchiuti	224/311
5,083,827	1/1992	Hollenbaugh, Sr.	296/37.1
5,269,447	12/1993	Gower et al.	224/42.42

*Primary Examiner*—James M. Gandy  
*Attorney, Agent, or Firm*—Olive & Olive

[57] **CLAIM**

The ornamental design for a mini van storage unit, as shown and described.

**DESCRIPTION**

FIG. 1 is a rear perspective view of a mini van storage unit showing my new design in position of use it being

understood that the mini van is depicted in broken lines for illustrative purposes only and forms no part of the claimed design;

FIG. 2 is an enlarged exploded perspective view of the upper and lower trays of the mini van storage unit of the invention;

FIG. 3 is an enlarged top plan view of the upper tray thereof shown separately for clarity of illustration;

FIG. 4 is a rear elevation view of the upper tray of FIG. 3;

FIG. 5 is a right side elevation view of the upper tray of FIG. 3;

FIG. 6 is a front elevation view of the upper tray of FIG. 3;

FIG. 7 is a left side elevation view of the upper tray of FIG. 3;

FIG. 8 is a bottom plan view of the upper tray of FIG. 3;

FIG. 9 is an enlarged top plan view of the lower tray thereof shown separately for clarity of illustration;

FIG. 10 is a rear elevation view of the lower tray of FIG. 9;

FIG. 11 is a right side elevation view of the lower tray of FIG. 9;

FIG. 12 is a front elevation view of the lower tray of FIG. 9;

FIG. 13 is a left side elevation view of the lower tray of FIG. 9; and,

FIG. 14 is a bottom plan view of the lower tray of FIG. 9.

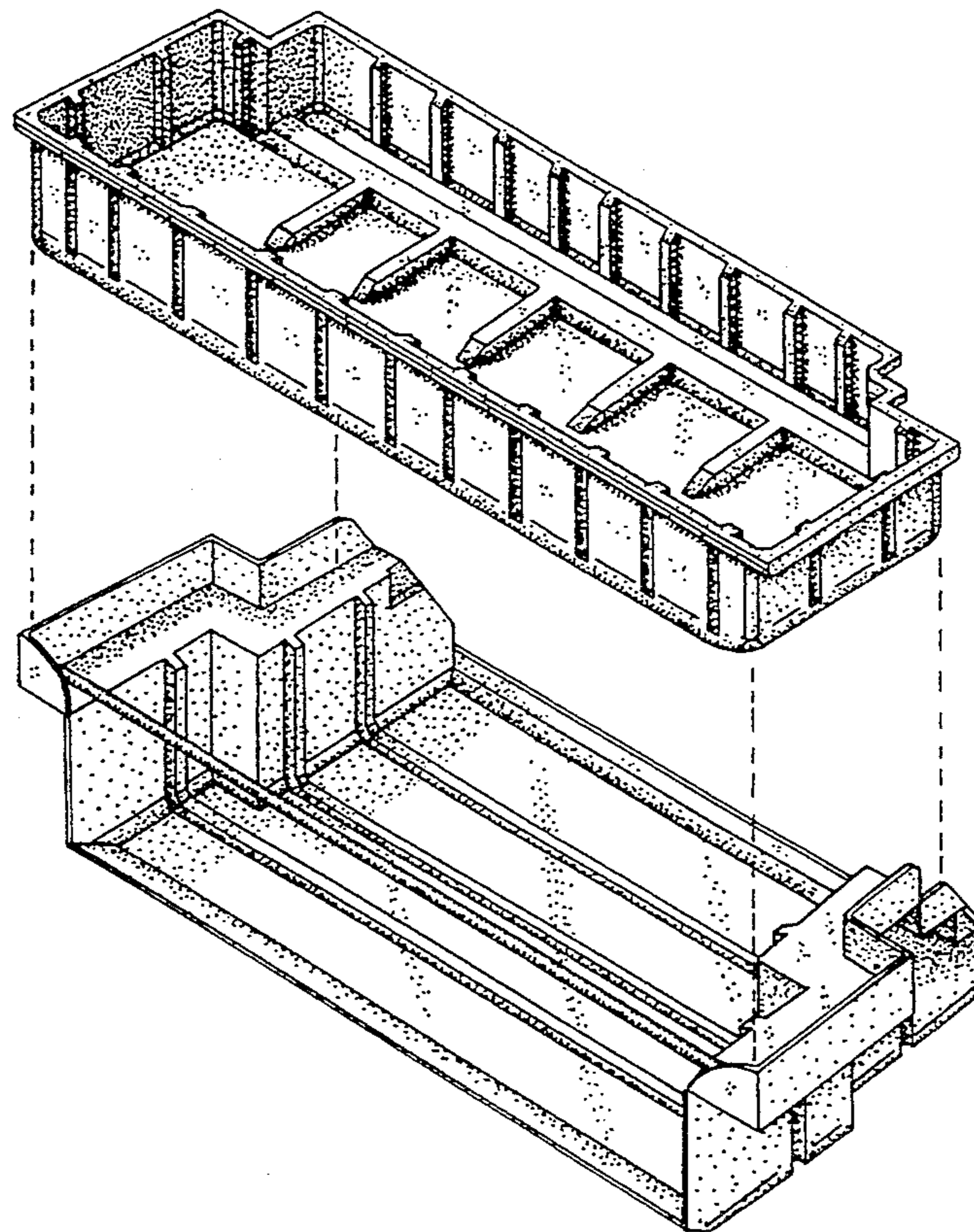

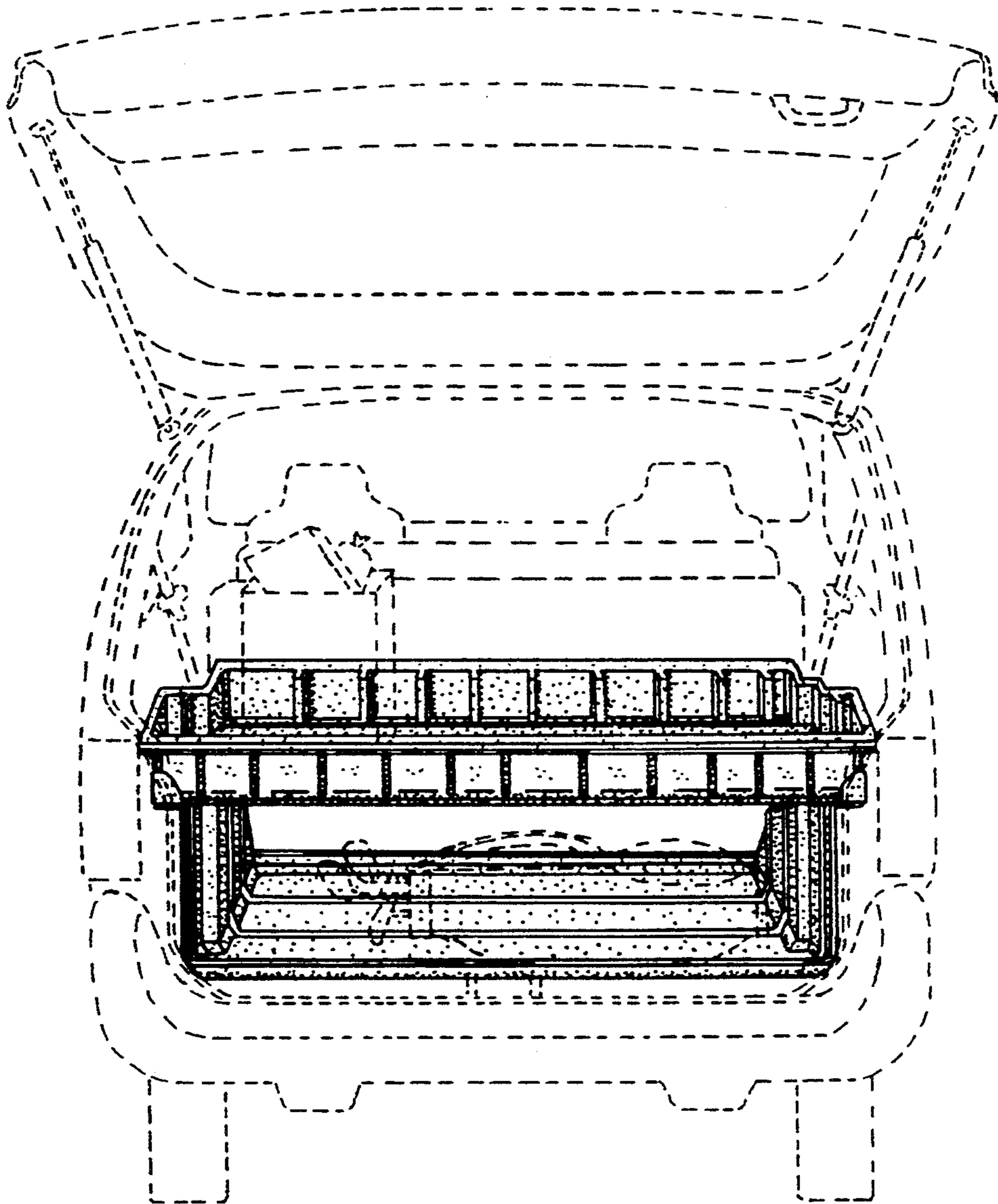

**FIG. 1**



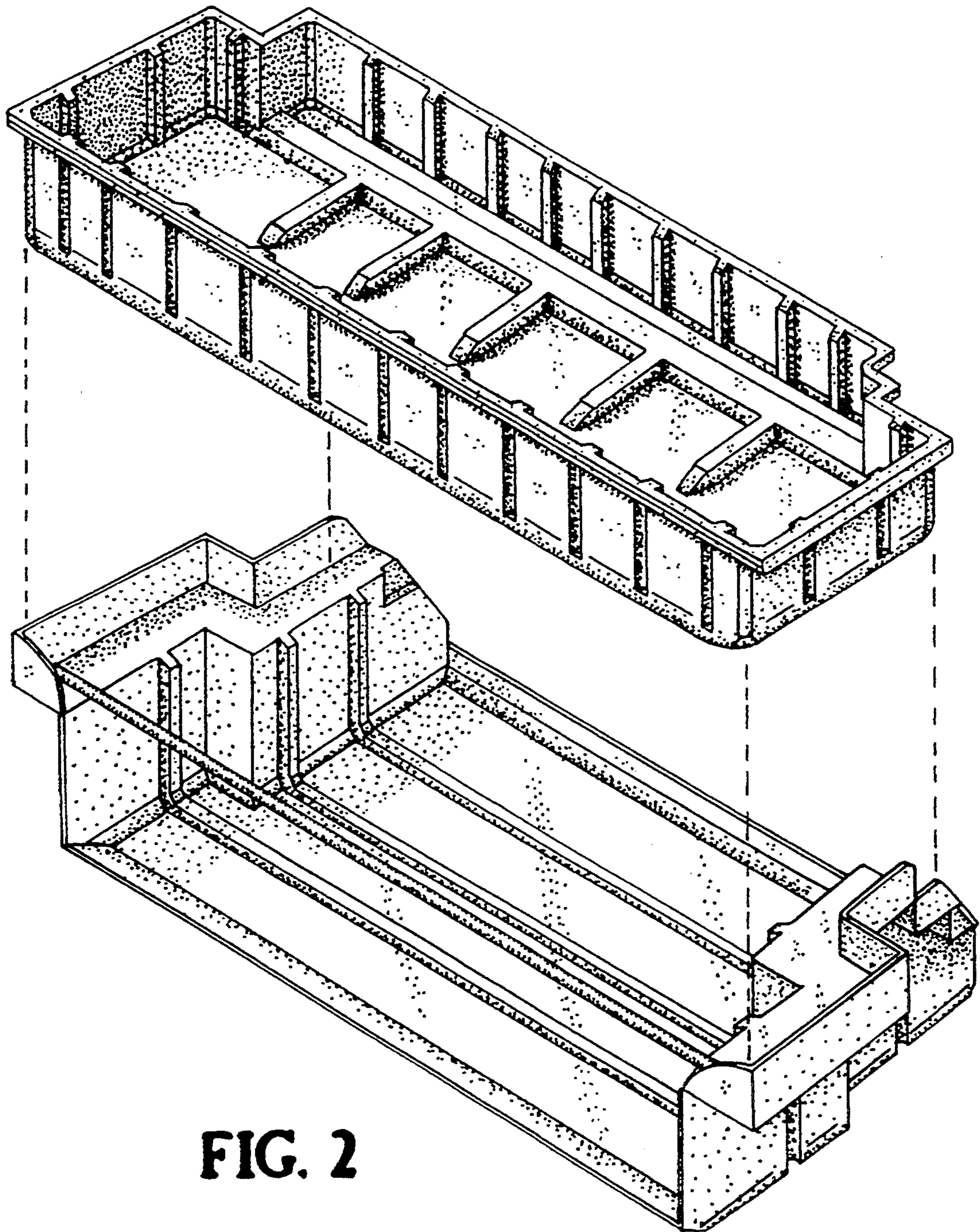

**FIG. 2**

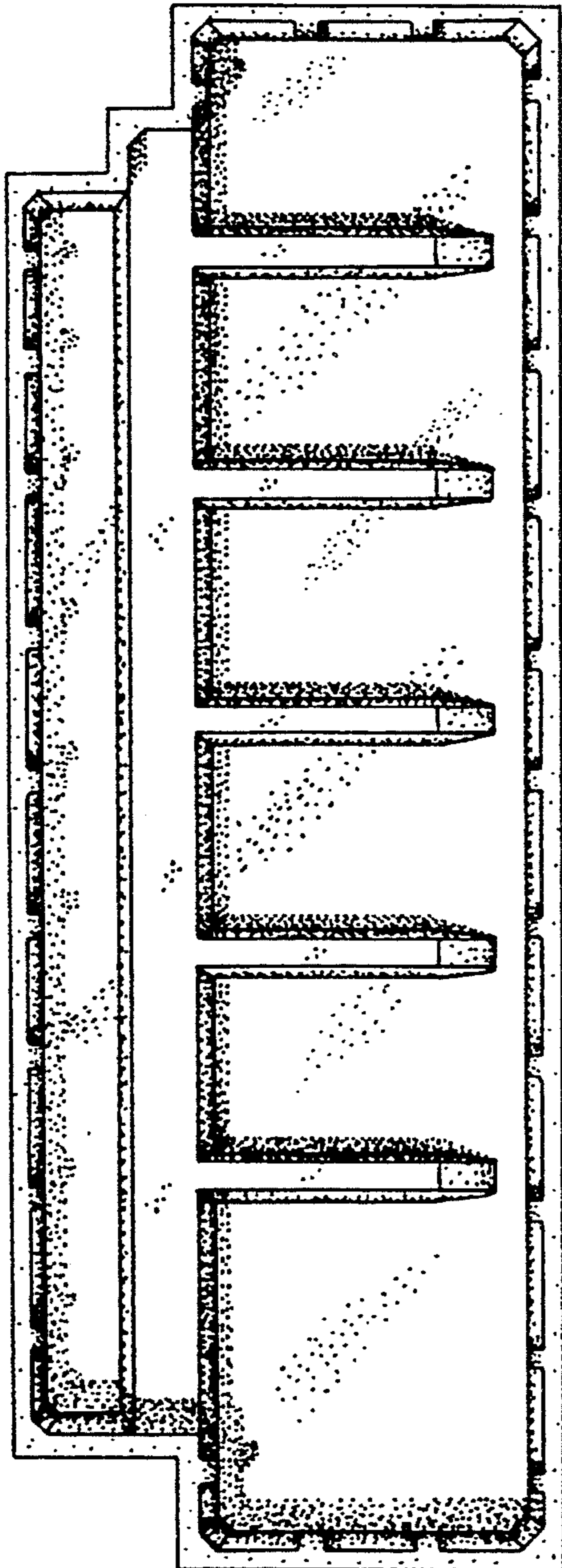

FIG. 3

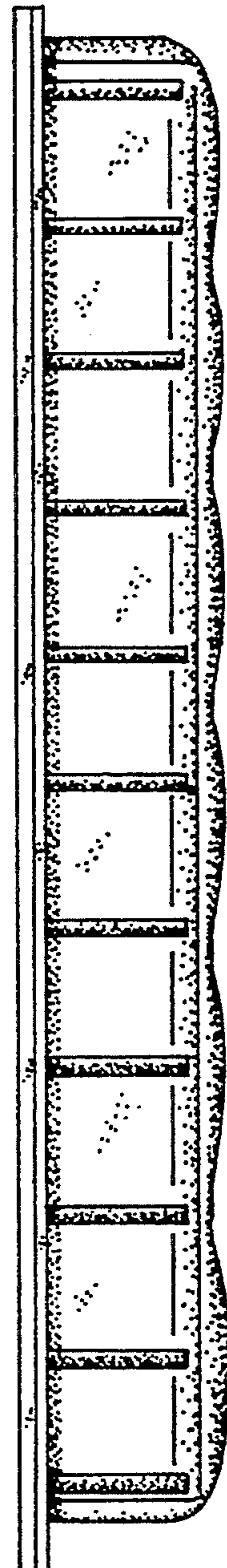

FIG. 4

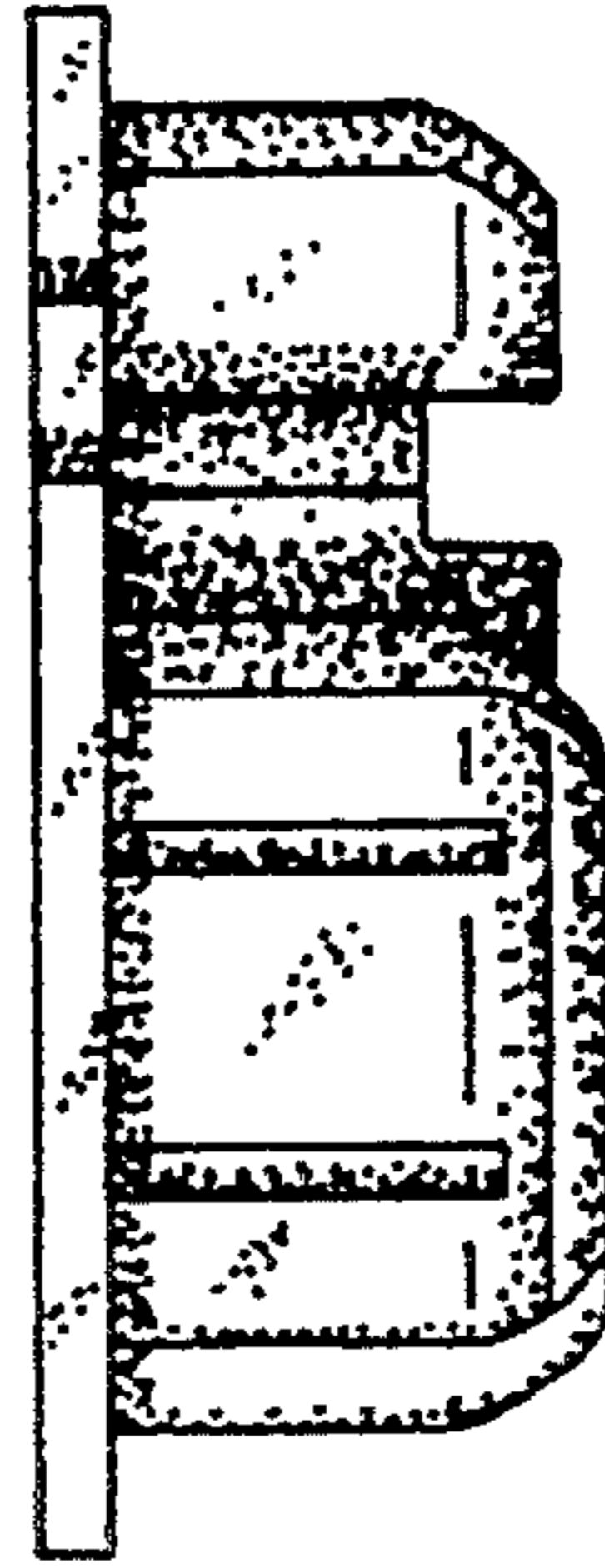

FIG. 5



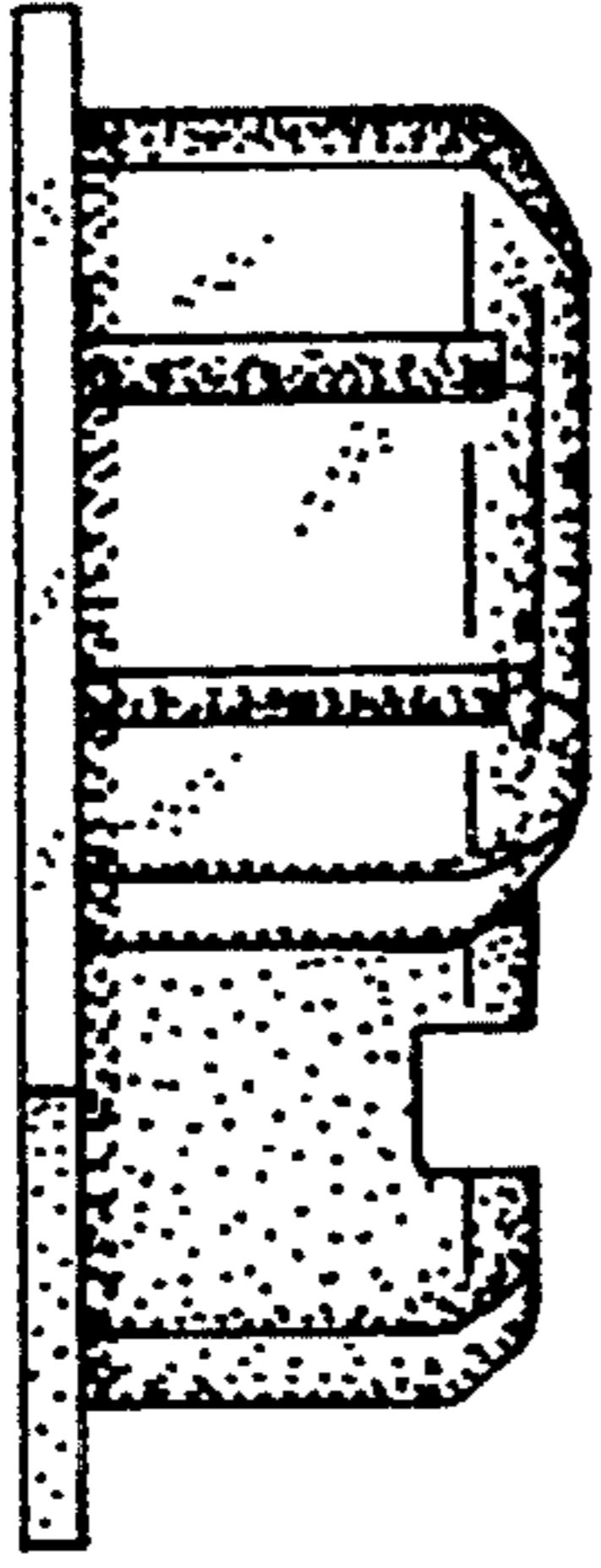

FIG. 7

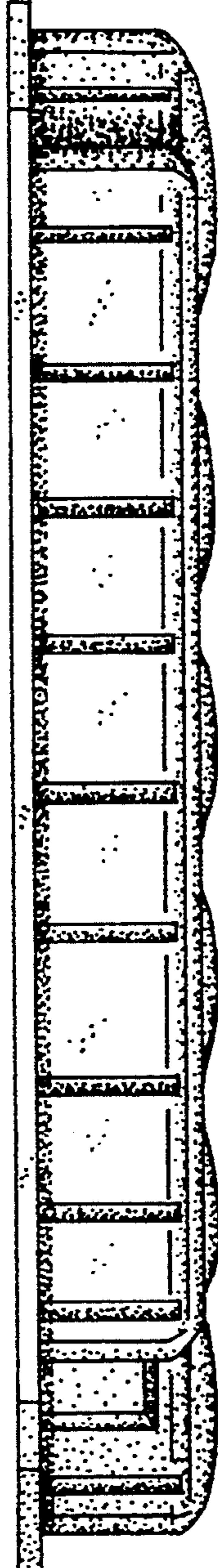

FIG. 6

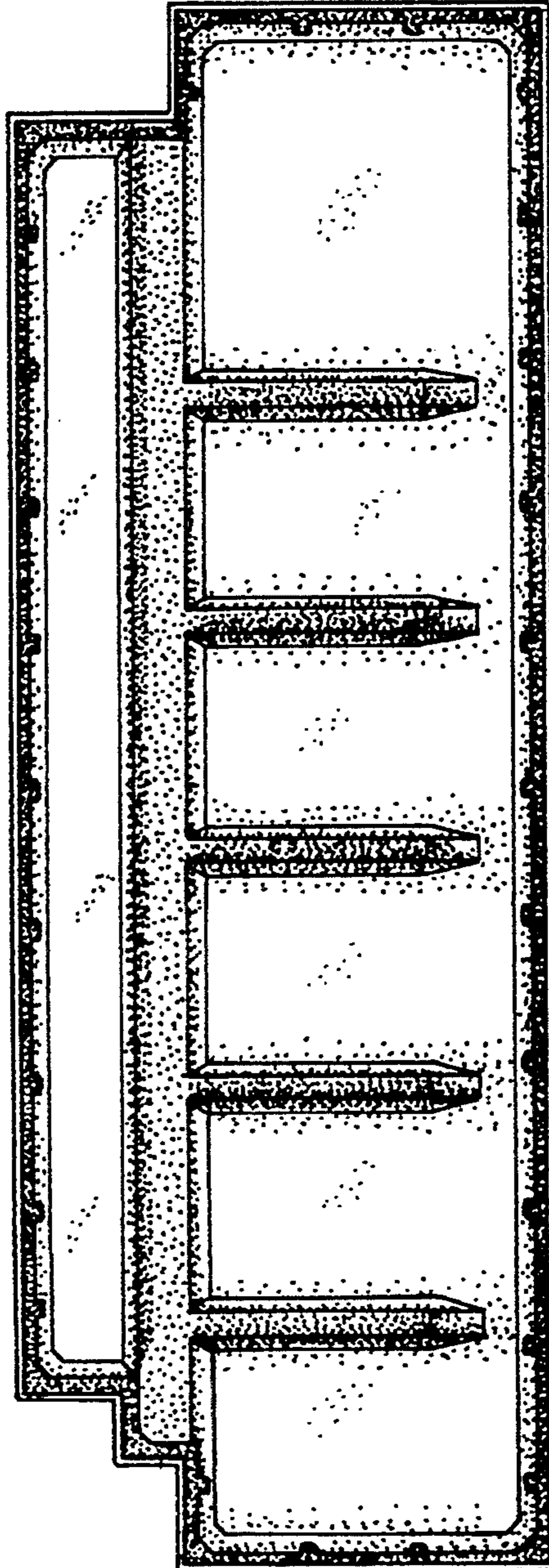

FIG. 8

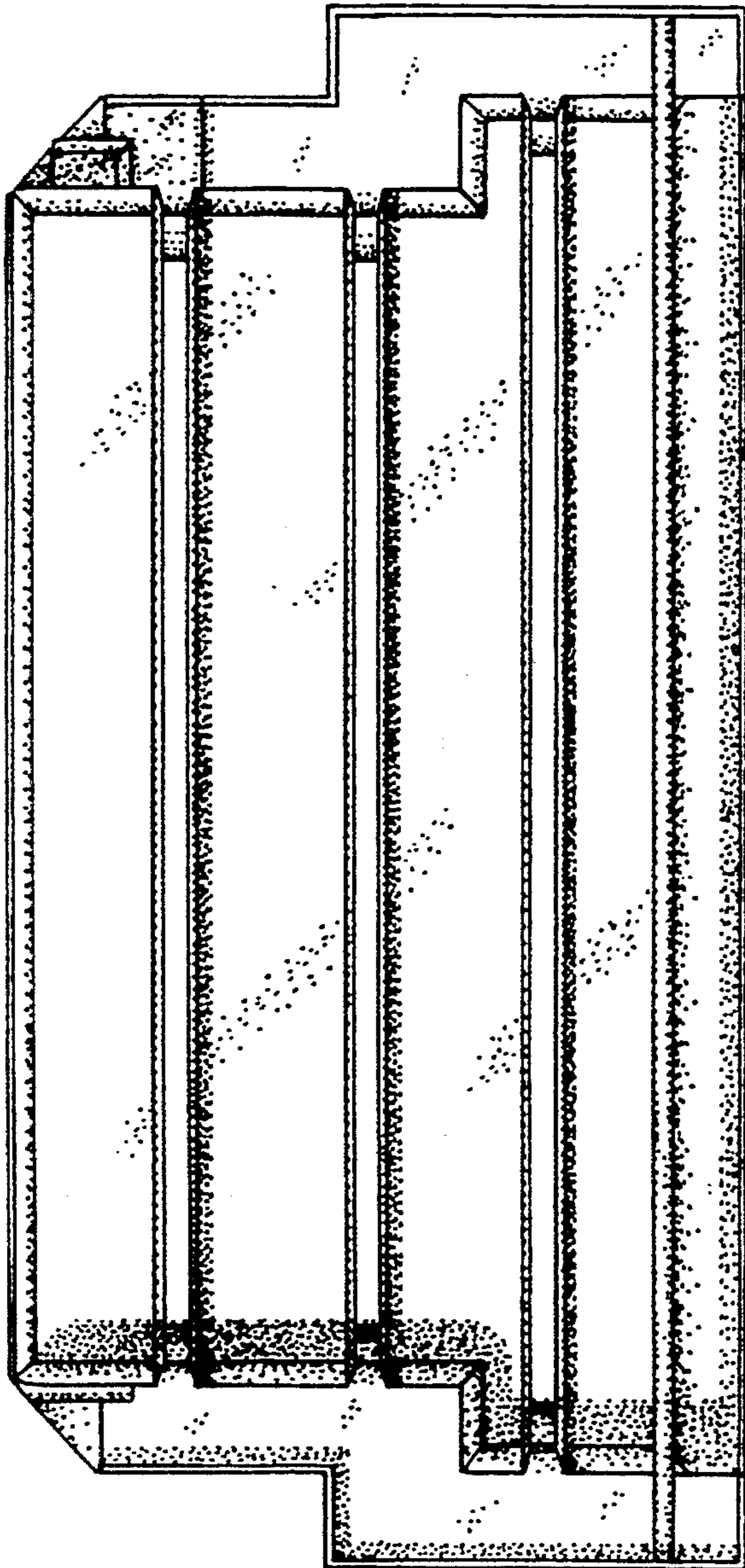

FIG. 9

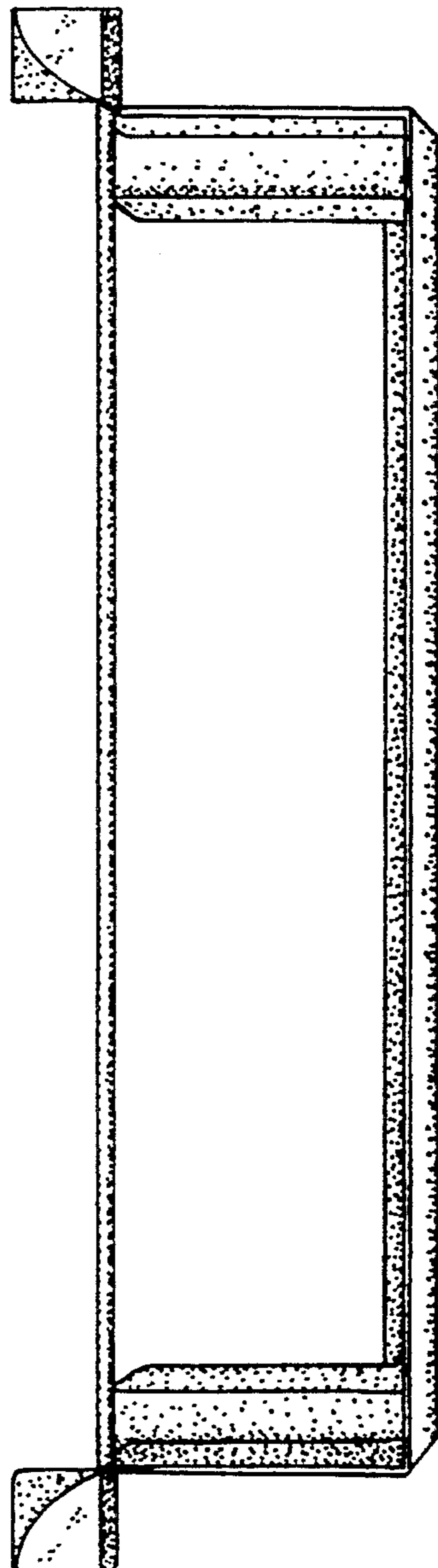

FIG. 10

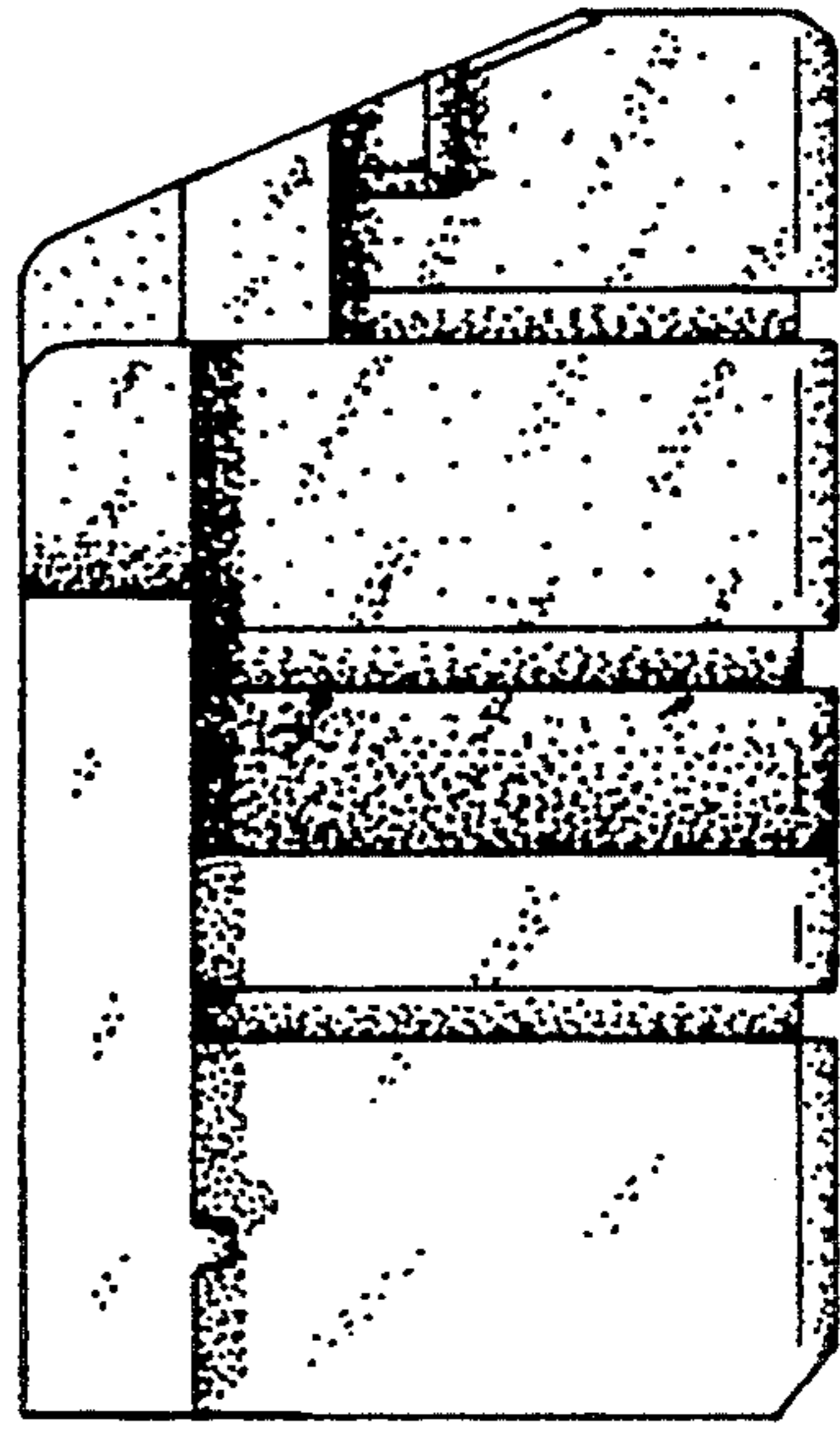

FIG. 11



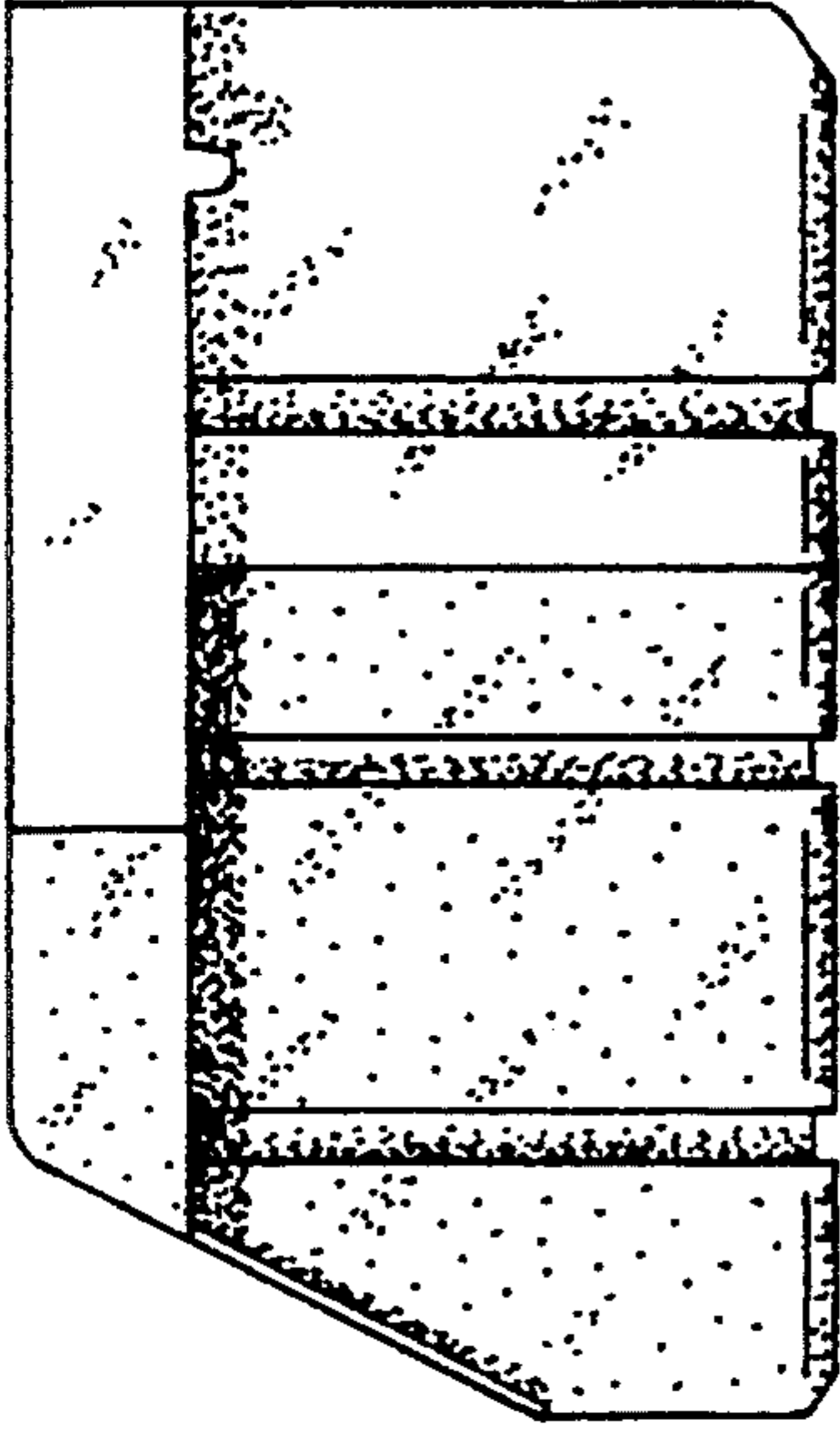

FIG. 13

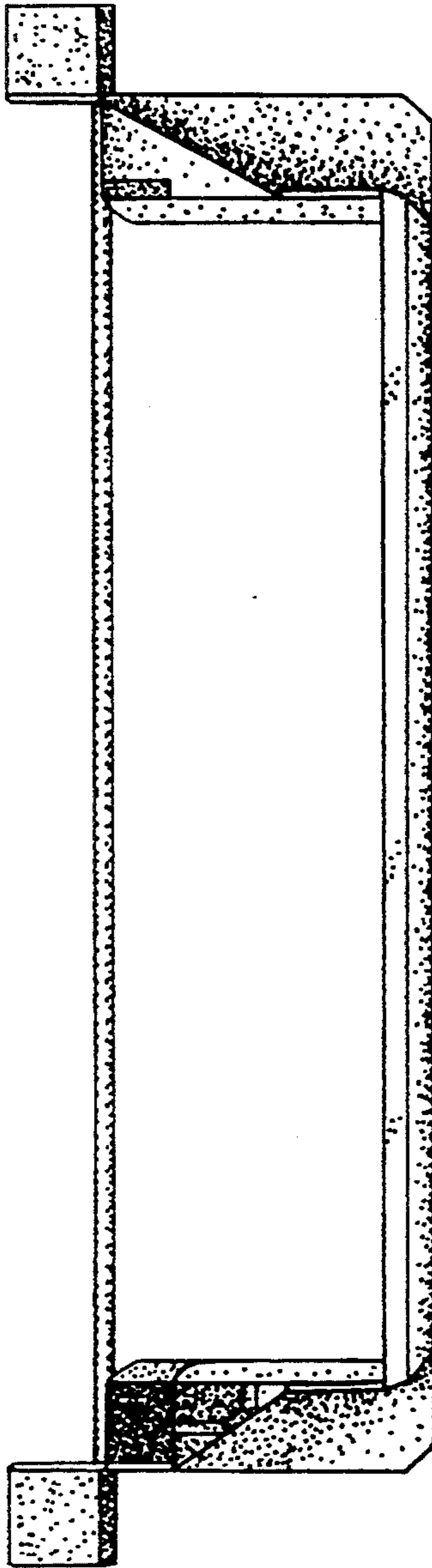

FIG. 12

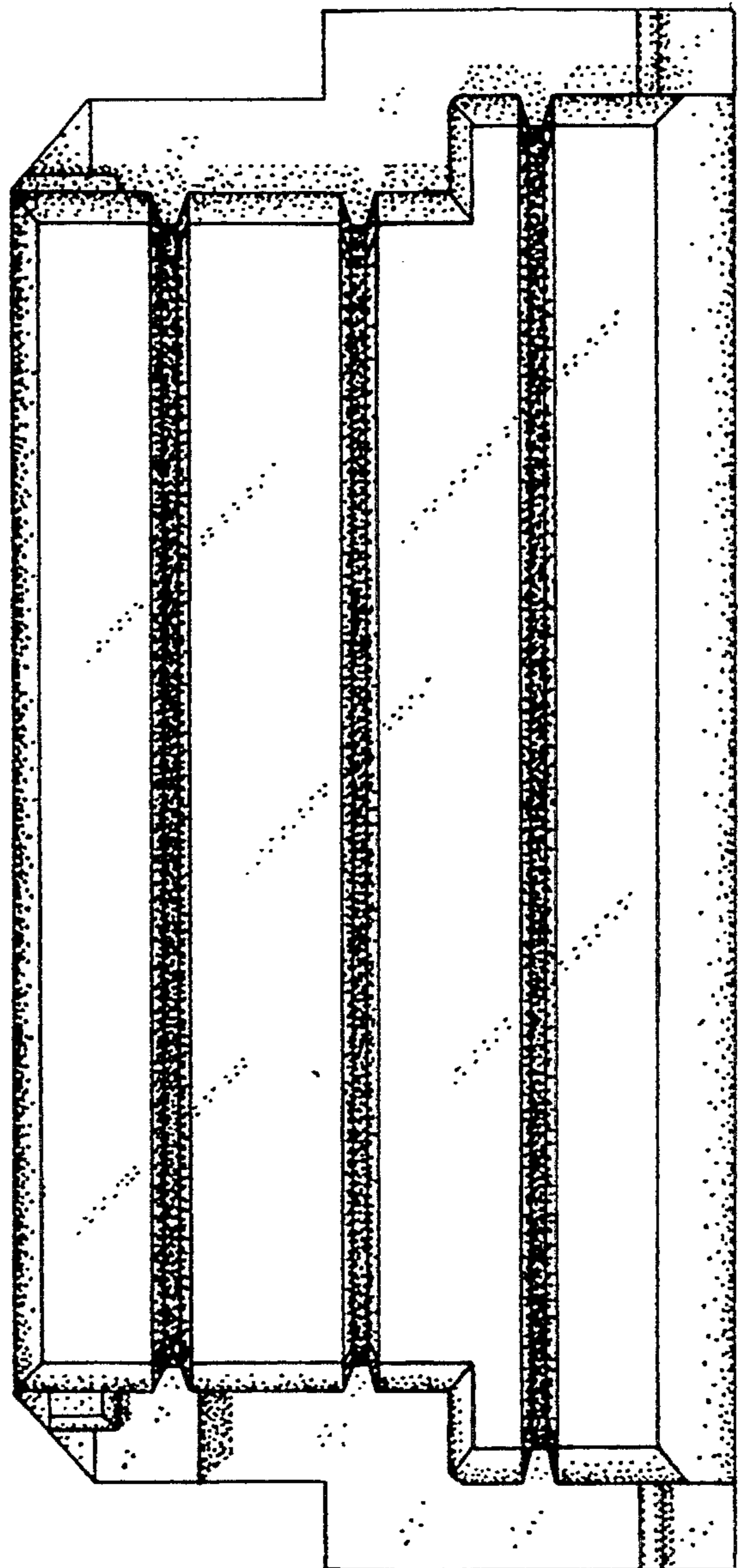

FIG. 14