



US00D357863S

United States Patent [19]

[11] Patent Number: **Des. 357,863**

Picozza

[45] Date of Patent: **** May 2, 1995**

[54] SEAL WITH CAPPED CONTAINER

[75] Inventor: **Augusto A. Picozza**, Orlando, Fla.

[73] Assignee: **Dart Industries Inc.**, Deerfield, Ill.

[**] Term: **14 Years**

[21] Appl. No.: **6,510**

[22] Filed: **Mar. 31, 1993**

[52] U.S. Cl. **D9/436; D9/449**

[58] Field of Search **D7/300-301, D7/305, 312, 589; D9/434-436, 438-441, 443, 447, 449, 452-454; 215/228-229, 238, 247-248, 329, 100.5; 220/212, 278, 360, 769; 222/391, 569**

[56] **References Cited**

U.S. PATENT DOCUMENTS

D. 258,350	2/1981	Scott et al.	D9/438
D. 259,103	5/1981	Scott et al.	D9/438
D. 262,192	12/1981	Wedge	D9/435
D. 315,781	3/1991	Hart et al.	D9/434
D. 316,039	4/1991	Sykes et al.	D9/436

D. 327,648	7/1992	Cane	D9/436
2,500,687	3/1950	Kamp et al. .	
3,204,813	9/1965	McCuskey et al.	D9/438 X
3,246,786	4/1966	Holley	215/100.5

Primary Examiner—Alan P. Douglas
Assistant Examiner—R. Spear
Attorney, Agent, or Firm—John A. Doninger

[57] **CLAIM**

The ornamental design for a seal with capped container, as shown and described.

DESCRIPTION

FIG. 1 is a top perspective view of a seal with capped container, showing my new design; FIG. 2 is a top plan view thereof; FIG. 3 is a bottom plan view thereof; FIG. 4 is a front elevational view thereof; FIG. 5 is a right side elevational view thereof, the opposite side being a mirror image thereof; FIG. 6 is a rear elevational view thereof; FIG. 7 is an exploded perspective view thereof; and, FIG. 8 is a cross-sectional view thereof on line 8—8 in FIG. 2.

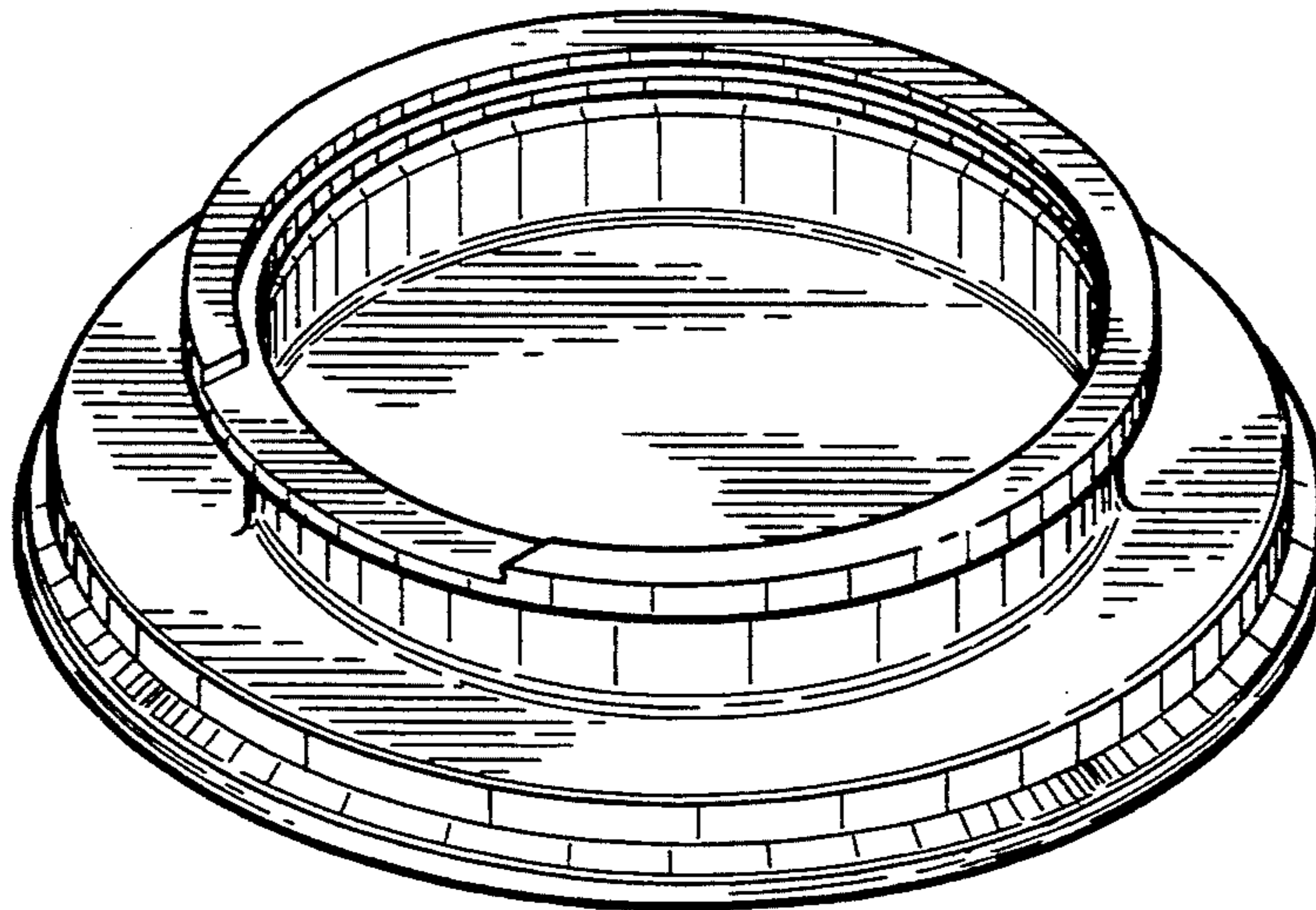
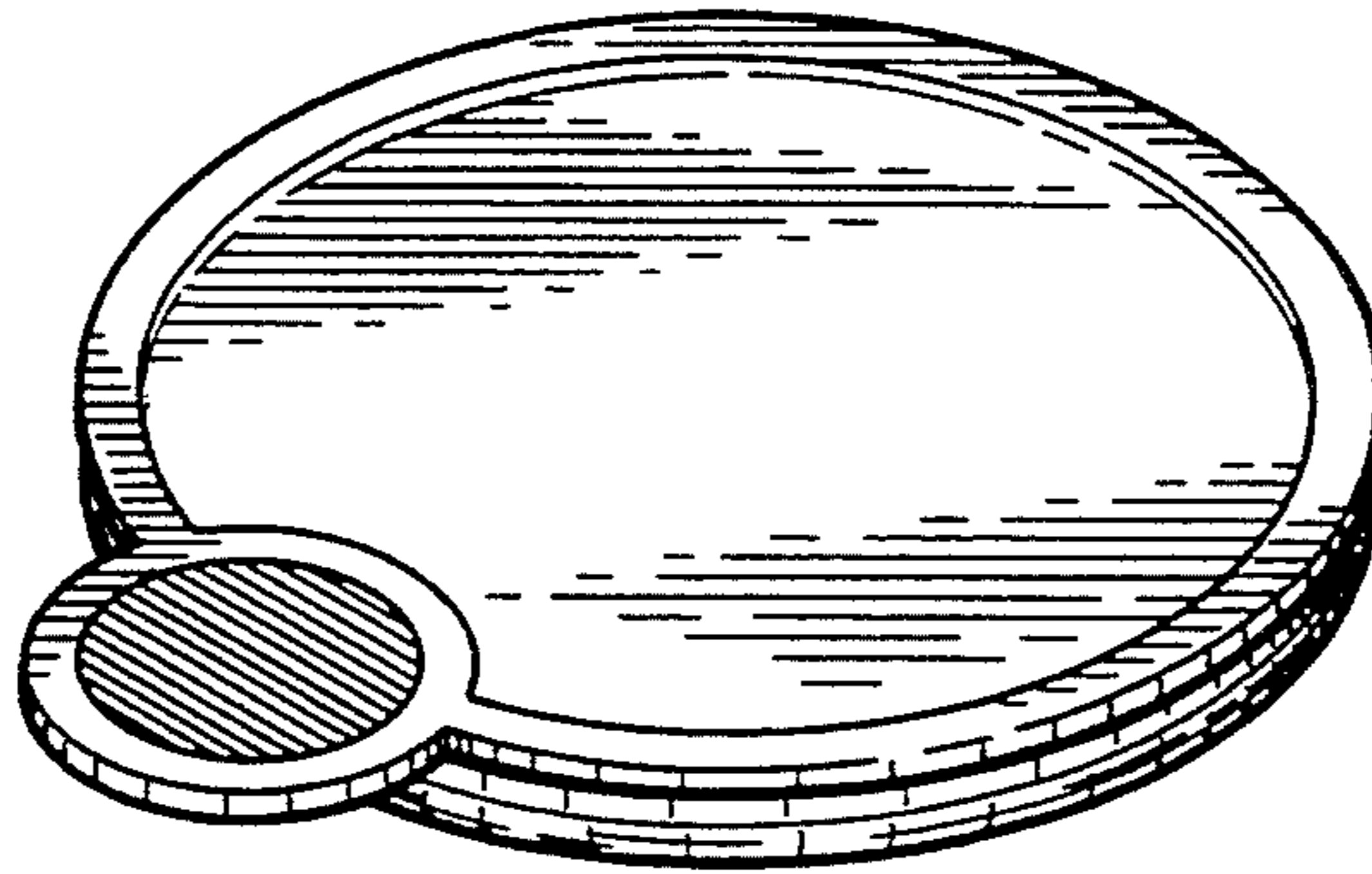

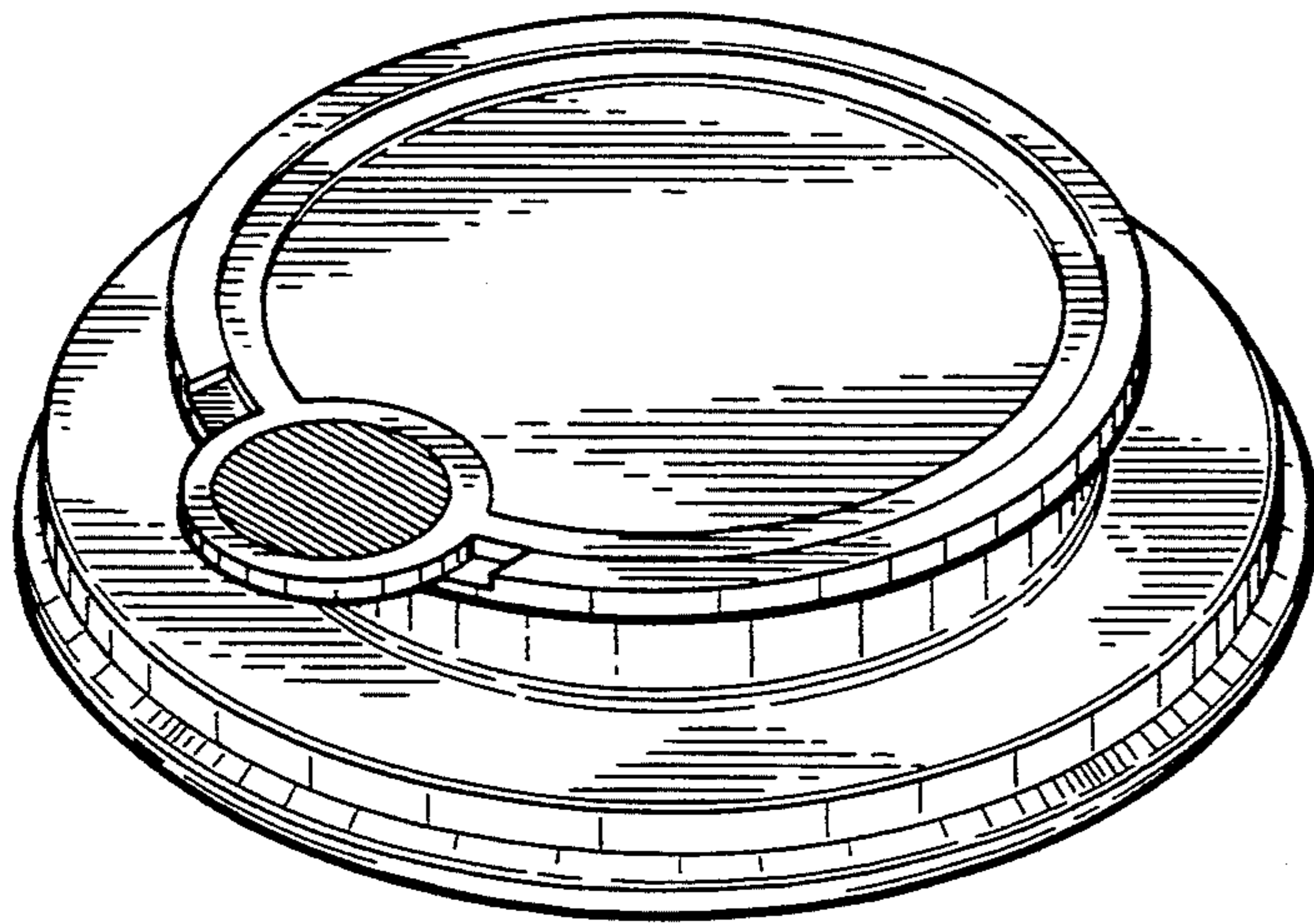

FIG. 1

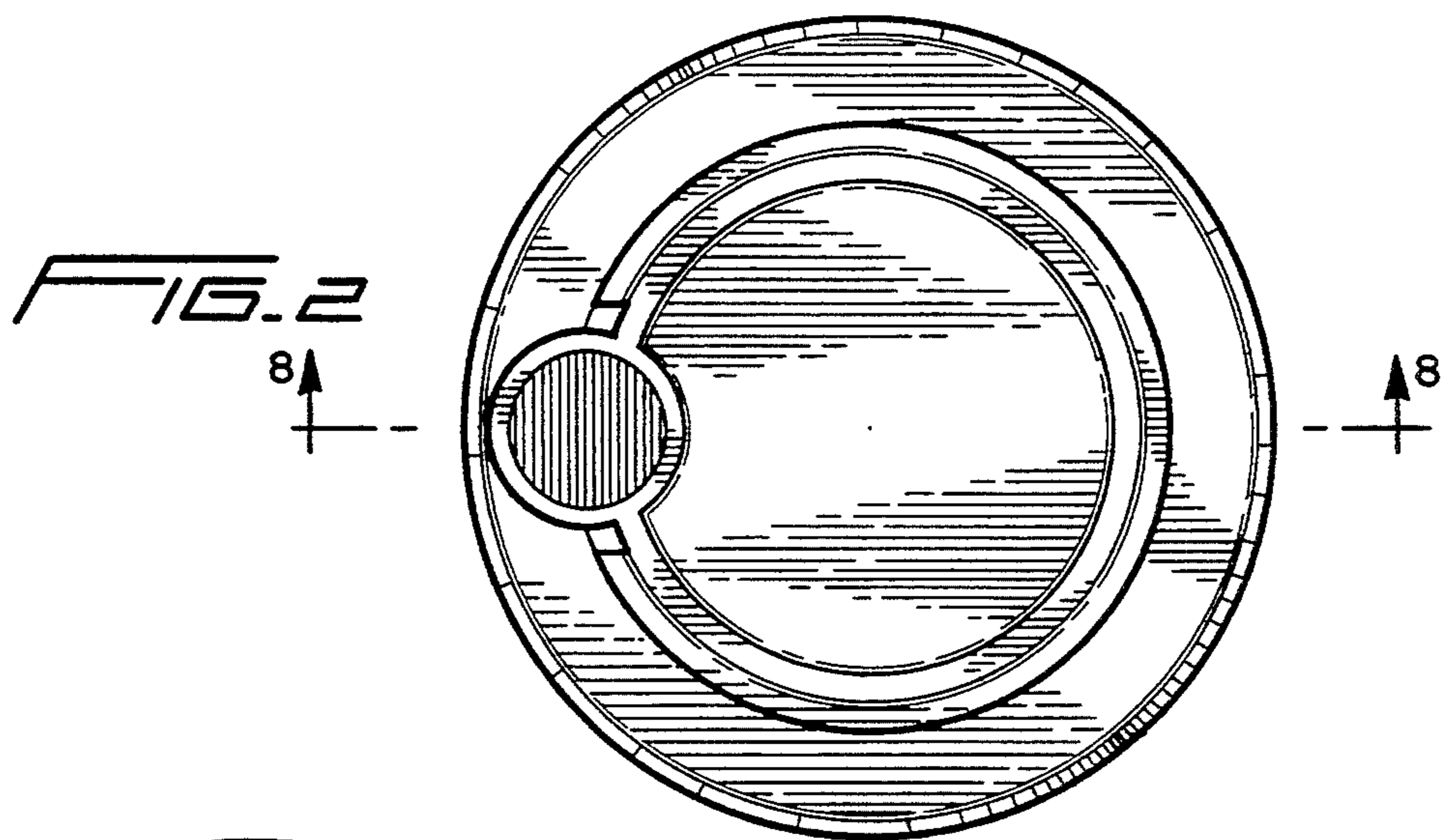

FIG. 2

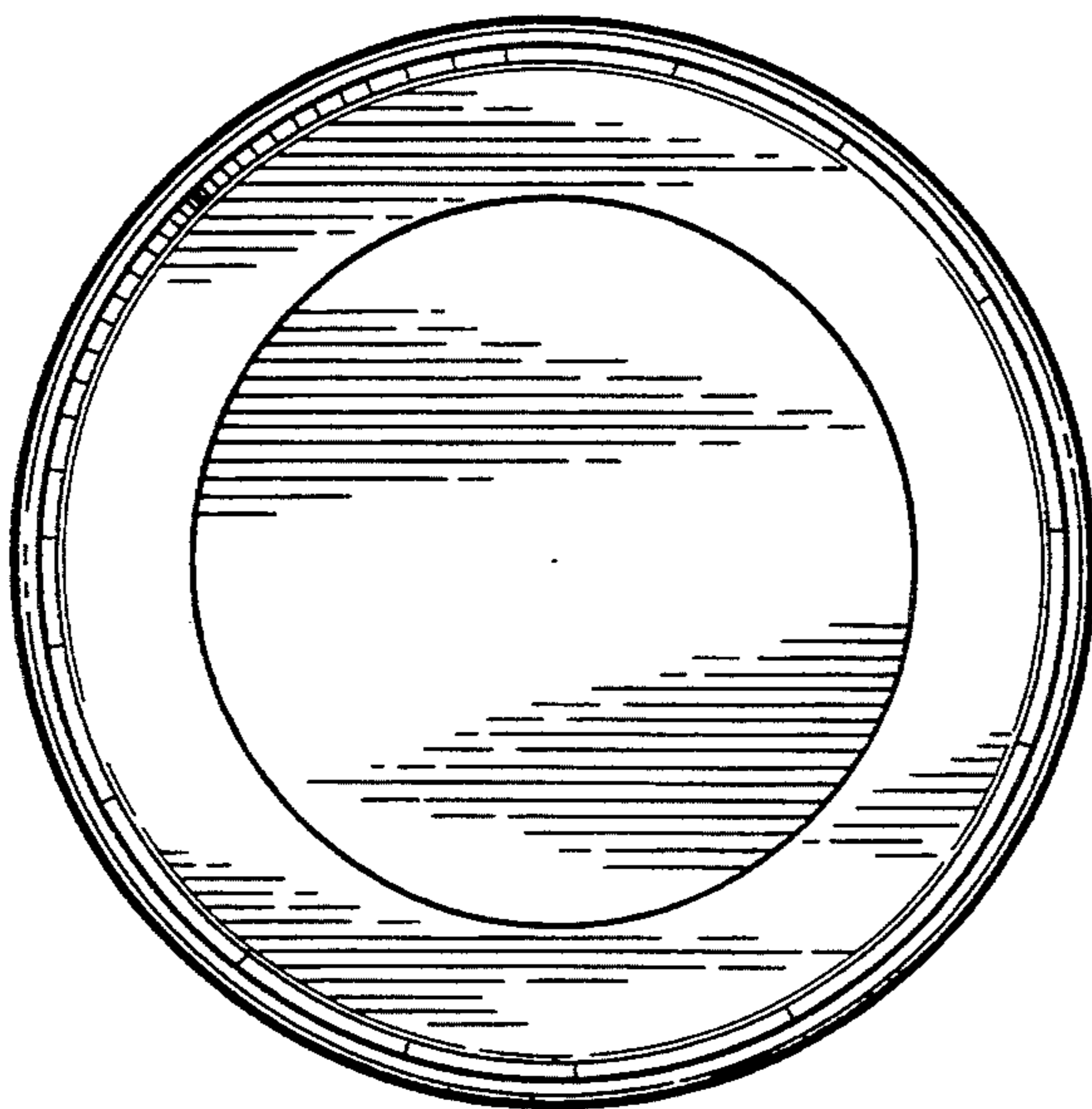

FIG. 3

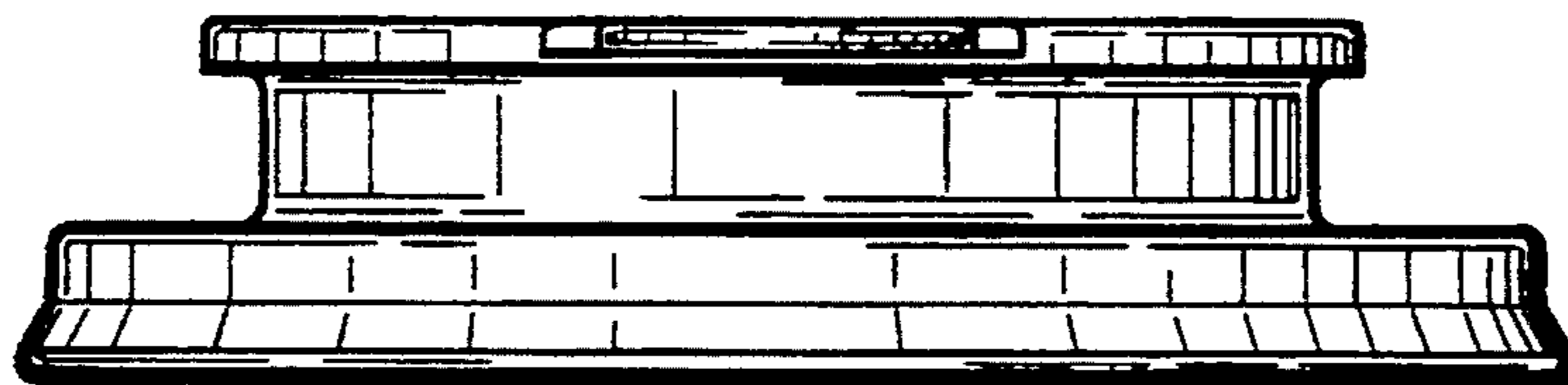

FIG. 4

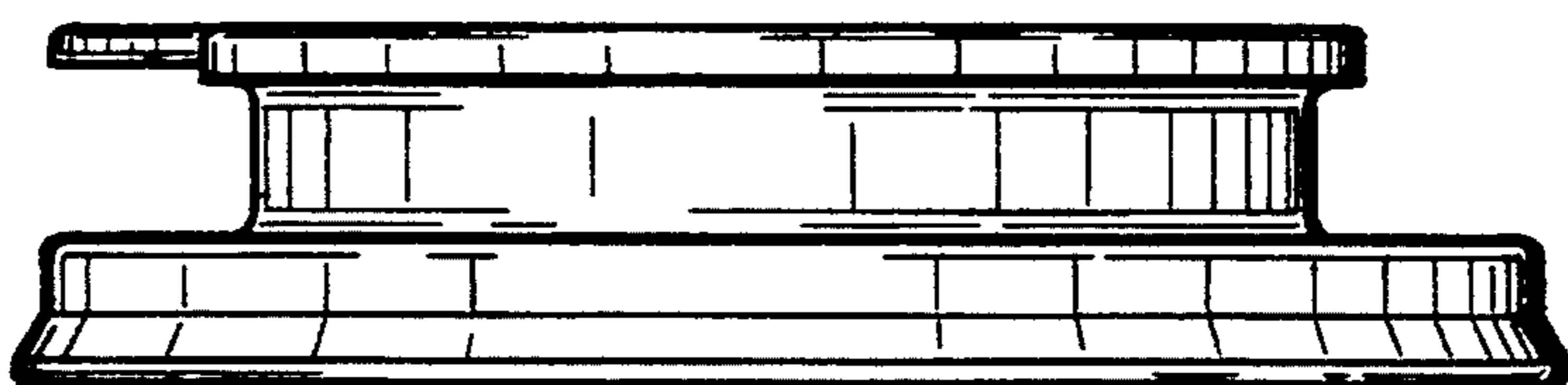

FIG. 5

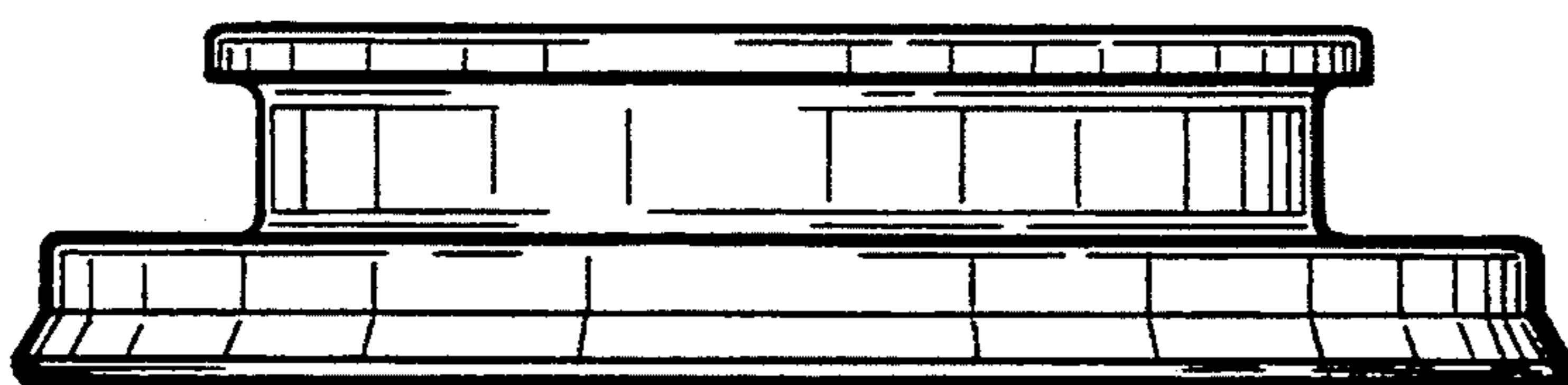

FIG. 6

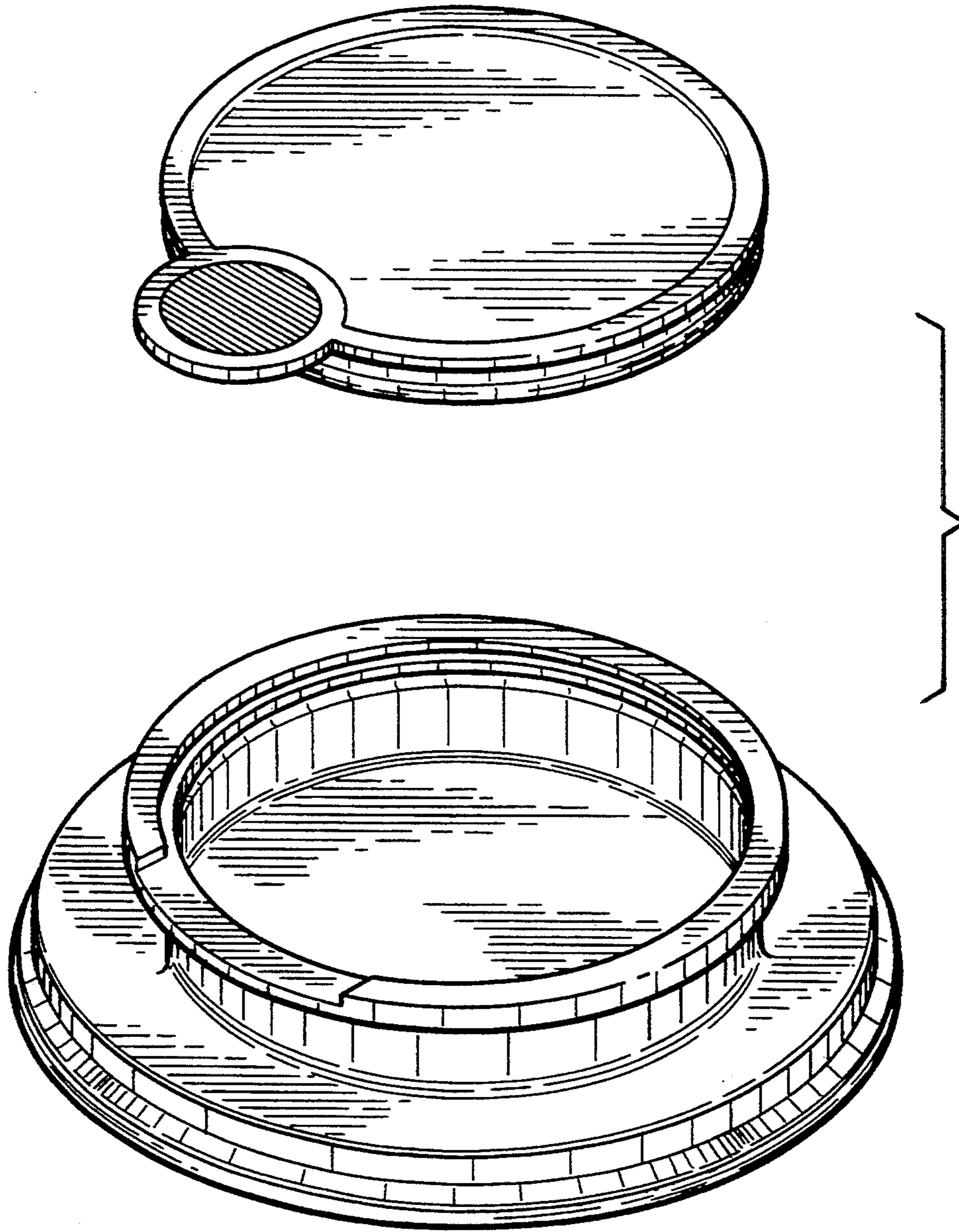

FIG. 7

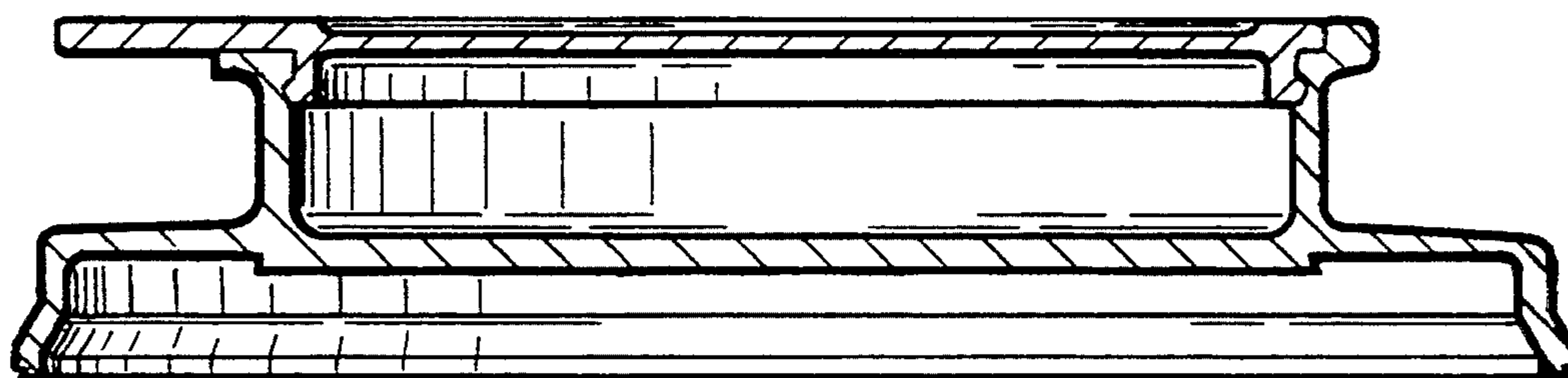

FIG. 8