



US00D357841S

United States Patent [19]

[11] Patent Number: **Des. 357,841**

Lehn et al.

[45] Date of Patent: **** May 2, 1995**

[54] TOWEL BAR

[75] Inventors: **John S. Lehn**, Reading; **Leslie A. Meck**, Blandon; **Julie A. Pirsch**, Wayne, all of Pa.

[73] Assignee: **Baldwin Hardware Corporation**, Reading, Pa.

[**] Term: **14 Years**

[21] Appl. No.: **14,378**

[22] Filed: **Oct. 20, 1993**

[52] U.S. Cl. **D6/549**

[58] Field of Search **D6/546-550;**
211/16, 86-87, 123

[56] References Cited

U.S. PATENT DOCUMENTS

- D. 293,867 1/1988 Fayerman et al. .
- D. 295,006 4/1988 Fayerman et al. .
- D. 296,964 8/1988 Jans D6/548
- D. 298,710 11/1988 Fayerman et al. .
- D. 299,398 1/1989 Fayerman et al. .
- D. 299,604 1/1989 Fayerman et al. .
- D. 329,559 9/1992 Paul D6/546 X

OTHER PUBLICATIONS

Baldwin Bath "Epic Accessories" Catalogue, Manhattan Style fixtures, p. 11.

Solid Brass Maxwell Collection Catalog (Pub'd prior to filing date).

Park Avenue Collection Solid Brass Catalog (pub'd prior to filing date).

Series Evergreen Catalog-Jado (pub'd prior to filing date).

Classica Collection-Melard (pub'd prior to filing date).

Primary Examiner—Brian N. Vinson

Attorney, Agent, or Firm—Myron B. Kapustij; Malcolm L. Sutherland

[57] CLAIM

The ornamental design for a towel bar, as shown and described.

DESCRIPTION

FIG. 1 is top perspective view of a towel bar showing our new design;

FIG. 2 is a front elevational view thereof;

FIG. 3 is a top plan view thereof;

FIG. 4 is a left side elevational view thereof;

FIG. 5 is a right side elevational view thereof; and,

FIG. 6 is a rear elevational view thereof.

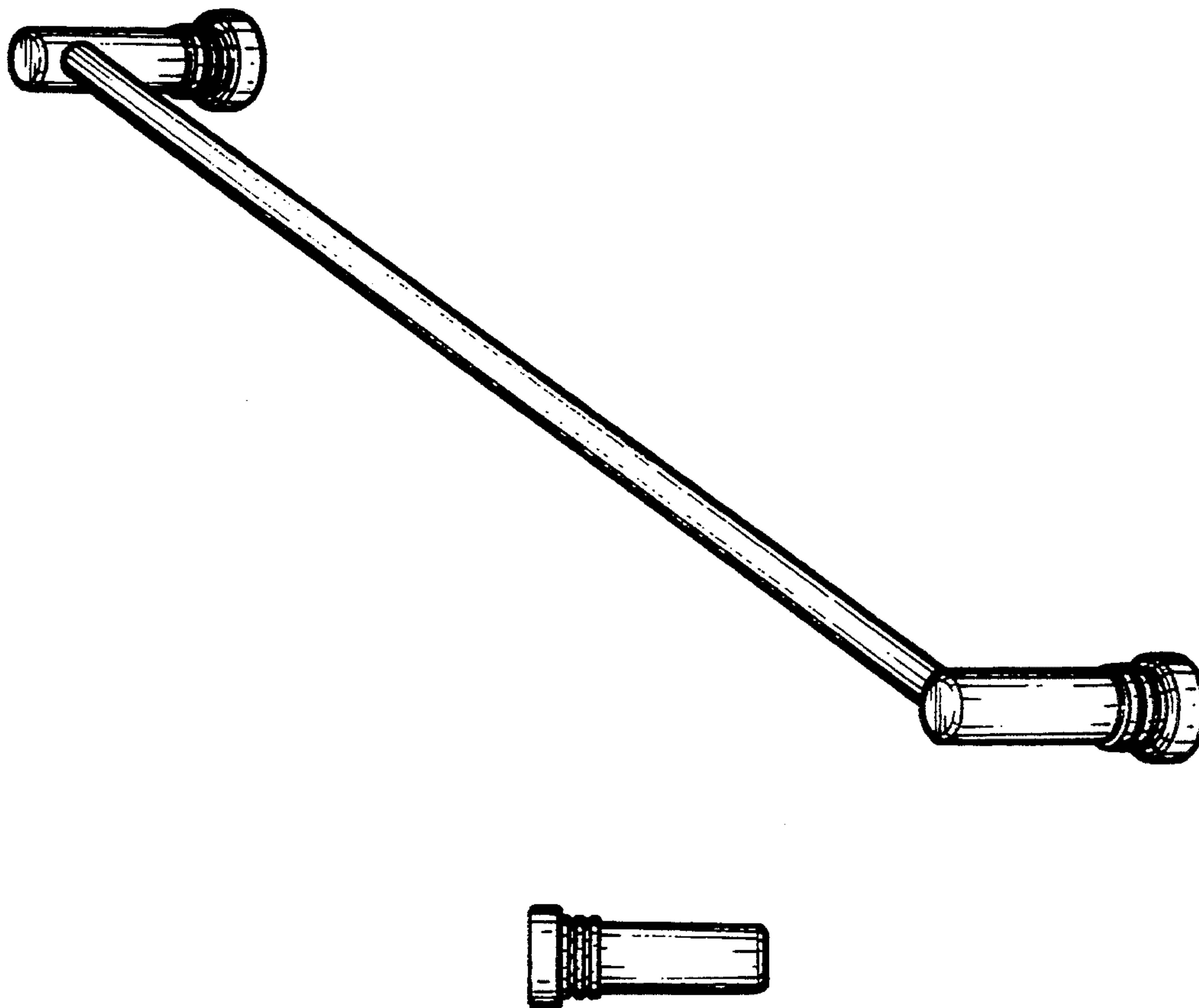

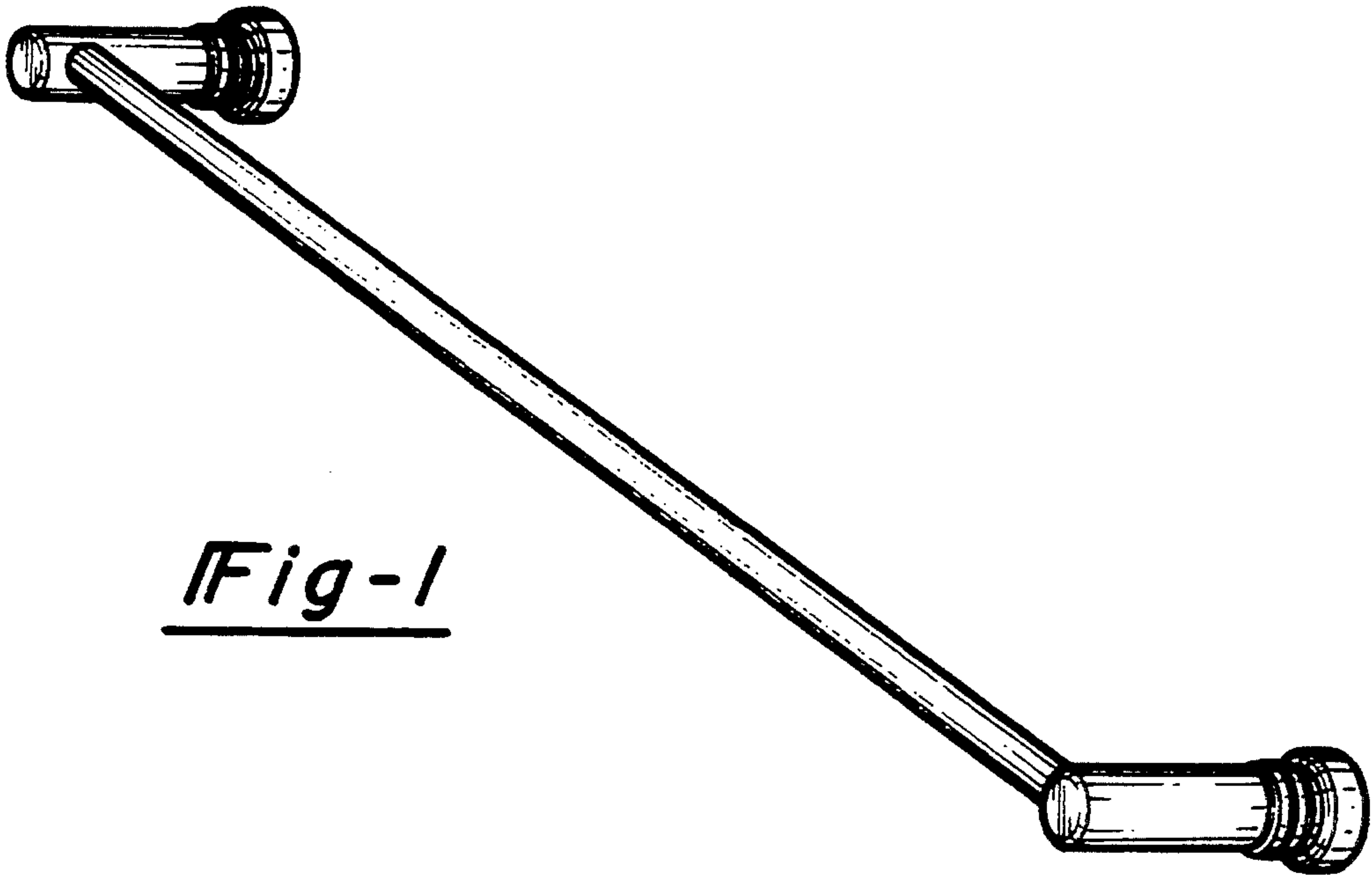

Fig-1

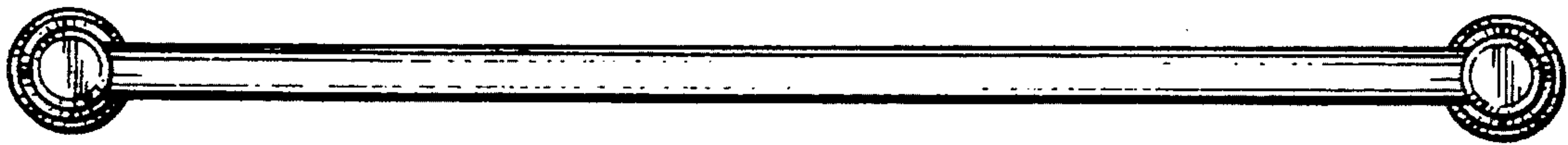

Fig-2

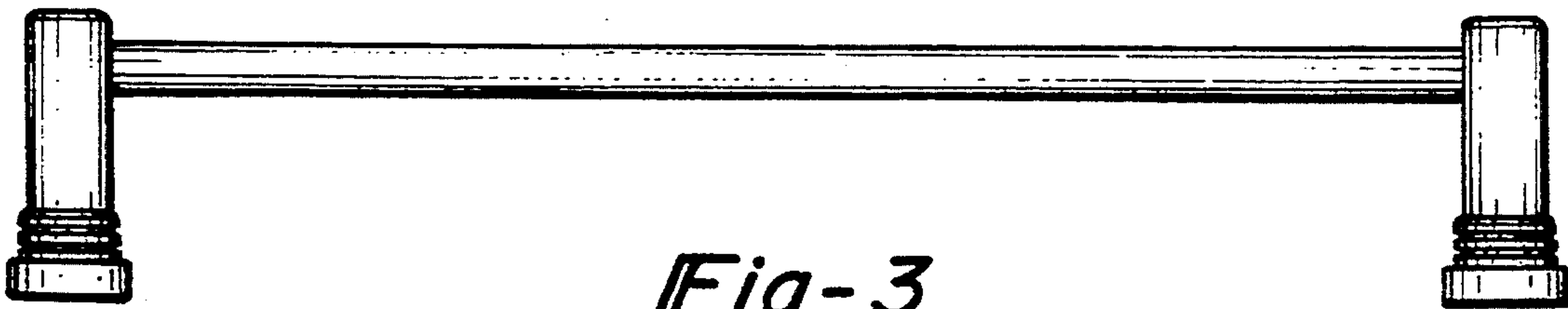

Fig-3

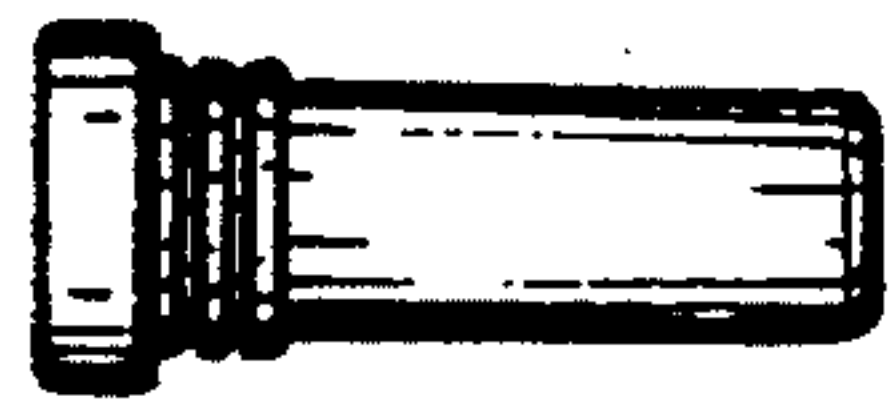

Fig-4

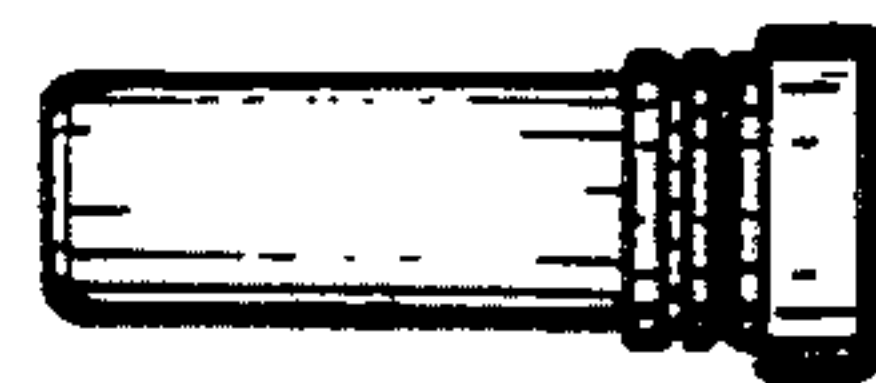

Fig-5

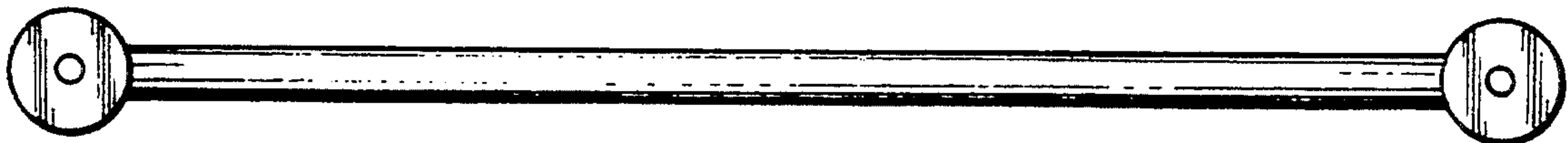

Fig-6