



US00D357762S

United States Patent [19]

[11] Patent Number: **Des. 357,762**

Douglas

[45] Date of Patent: **** Apr. 25, 1995**

[54] DECORATIVE HOUSING FOR WALL MOUNTED ELECTRICAL UNIT

[75] Inventor: **Patrick Douglas, Chicago, Ill.**

[73] Assignee: **Ecolab Inc., St. Paul, Minn.**

[**] Term: **14 Years**

[21] Appl. No.: **13,794**

[22] Filed: **Oct. 1, 1993**

[52] U.S. Cl. **D26/85; D10/104; D26/128**

[58] Field of Search **D26/72, 80-92, D26/113, 118, 128, 135, 136; 362/432, 147; D10/104, 106, 118; D22/122, 123**

[56] References Cited

U.S. PATENT DOCUMENTS

D. 77,408	1/1929	Hall, Jr.	D26/85
D. 109,522	5/1938	Perkins	D26/72 X
D. 112,215	11/1938	Rittenhouse	D10/118
D. 118,866	2/1940	Rittenhouse	D10/118
D. 168,260	11/1952	Gregg	D26/86
D. 325,954	5/1992	Lazzeroni, Sr. et al.	D22/123
D. 346,981	5/1994	Ratzlaff	D10/106
4,332,100	6/1982	Schneider	43/113

OTHER PUBLICATIONS

Brownlee Lighting Flyer, May 1987, Wall Lighting Fixture, Winchester-III.

Modern Plastics, Apr. 1946, p. 91, Door Chime.

Primary Examiner—Susan J. Lucas

Attorney, Agent, or Firm—Merchant, Gould, Smith, Edell, Welter & Schmidt

[57] CLAIM

The ornamental design for a decorative housing for wall mounted electrical unit, as shown and described.

DESCRIPTION

FIG. 1 is a perspective view showing a preferred embodiment of my new design;

FIG. 2 is a top view of my new design;

FIG. 3 is a front elevational view thereof on an enlarged scale;

FIG. 4 is a rear elevational view thereof on an enlarged scale;

FIG. 5 is a bottom view thereof on an enlarged scale; and,

FIG. 6 is a side elevational view thereof on an enlarged scale.

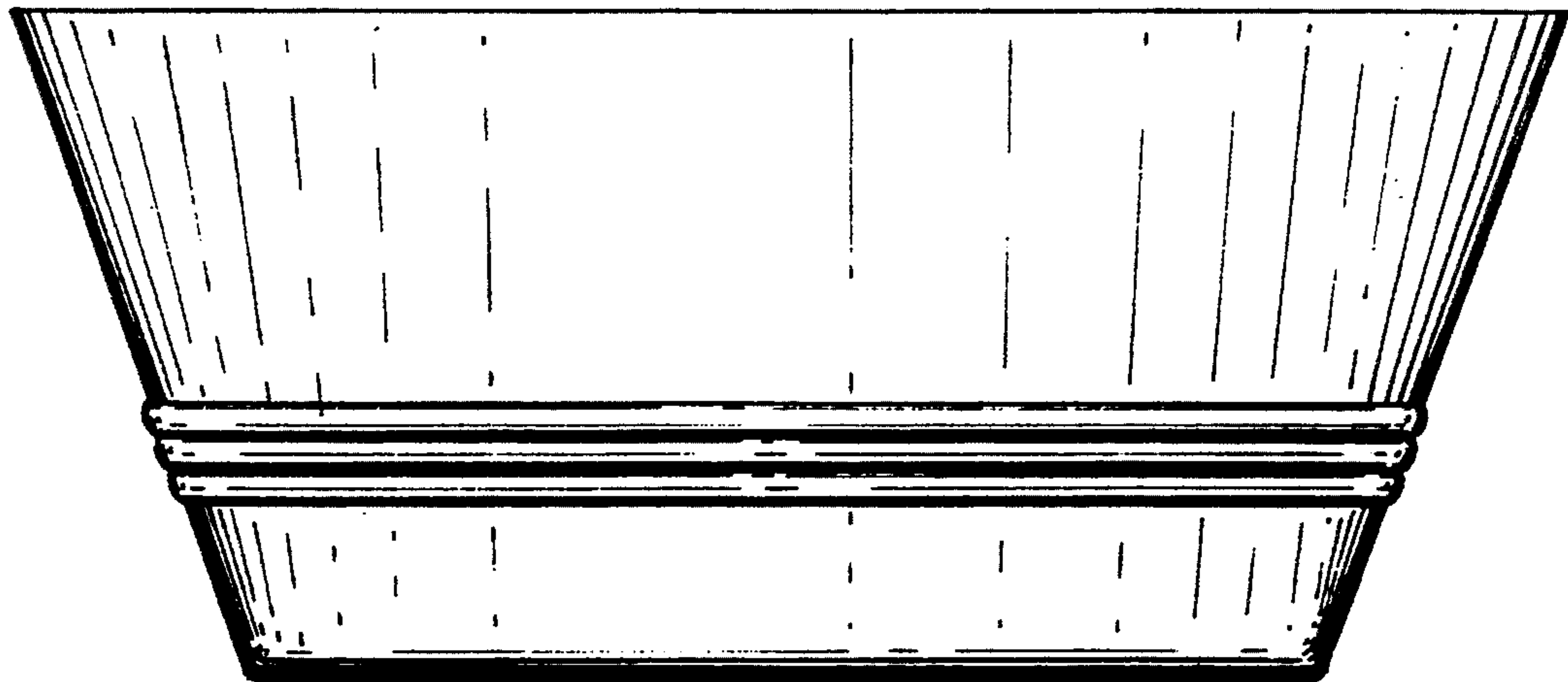
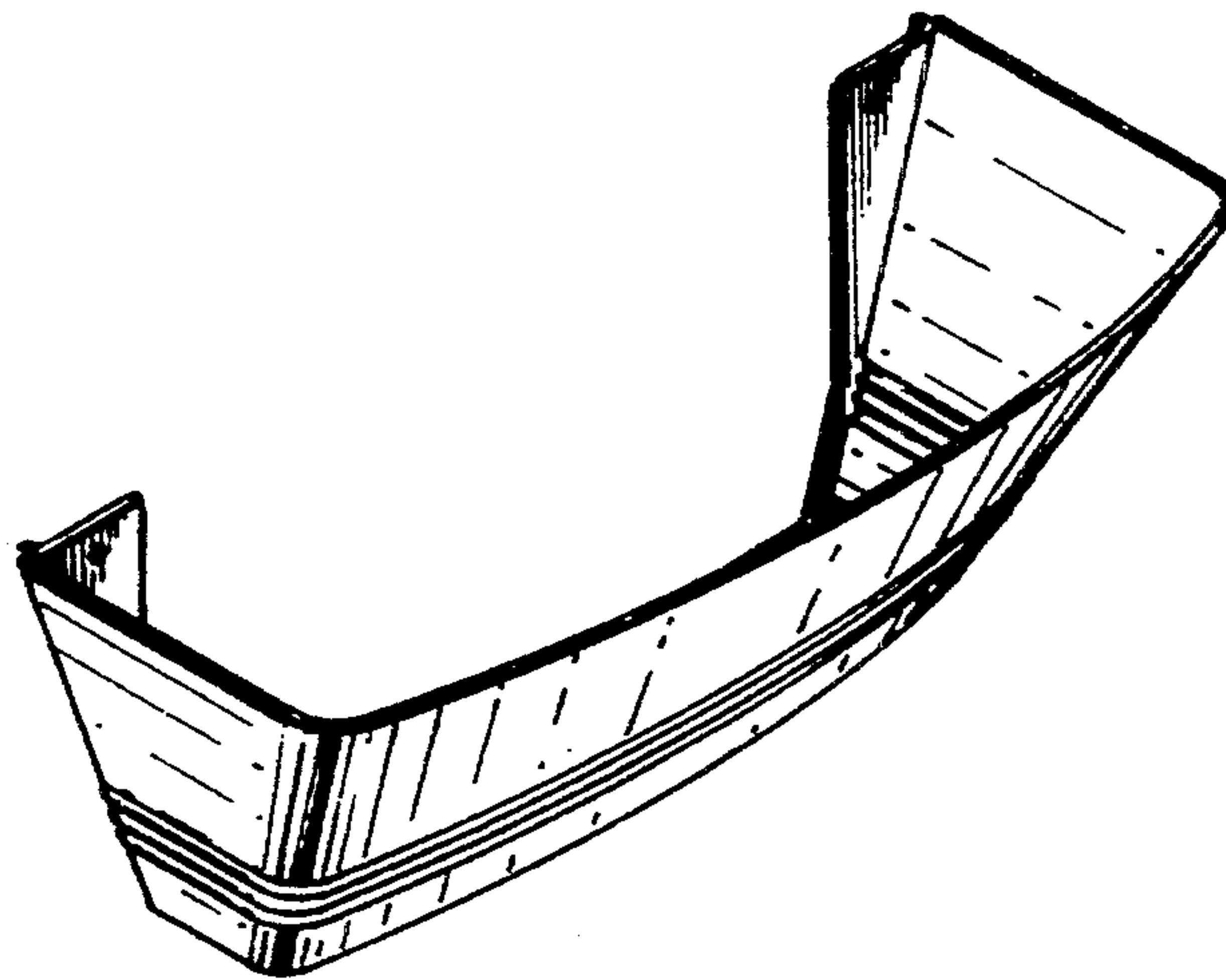

FIG. 1

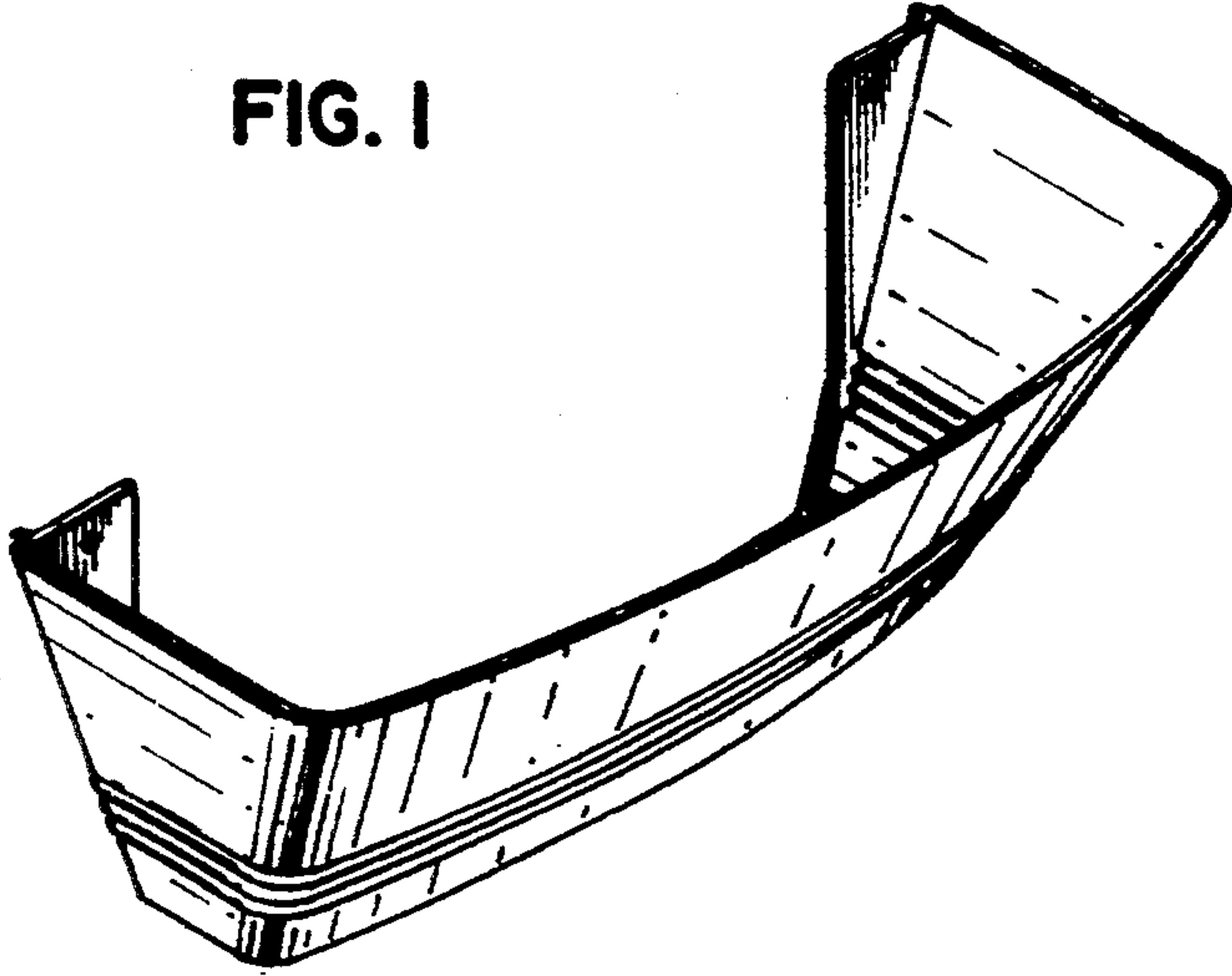

FIG. 2

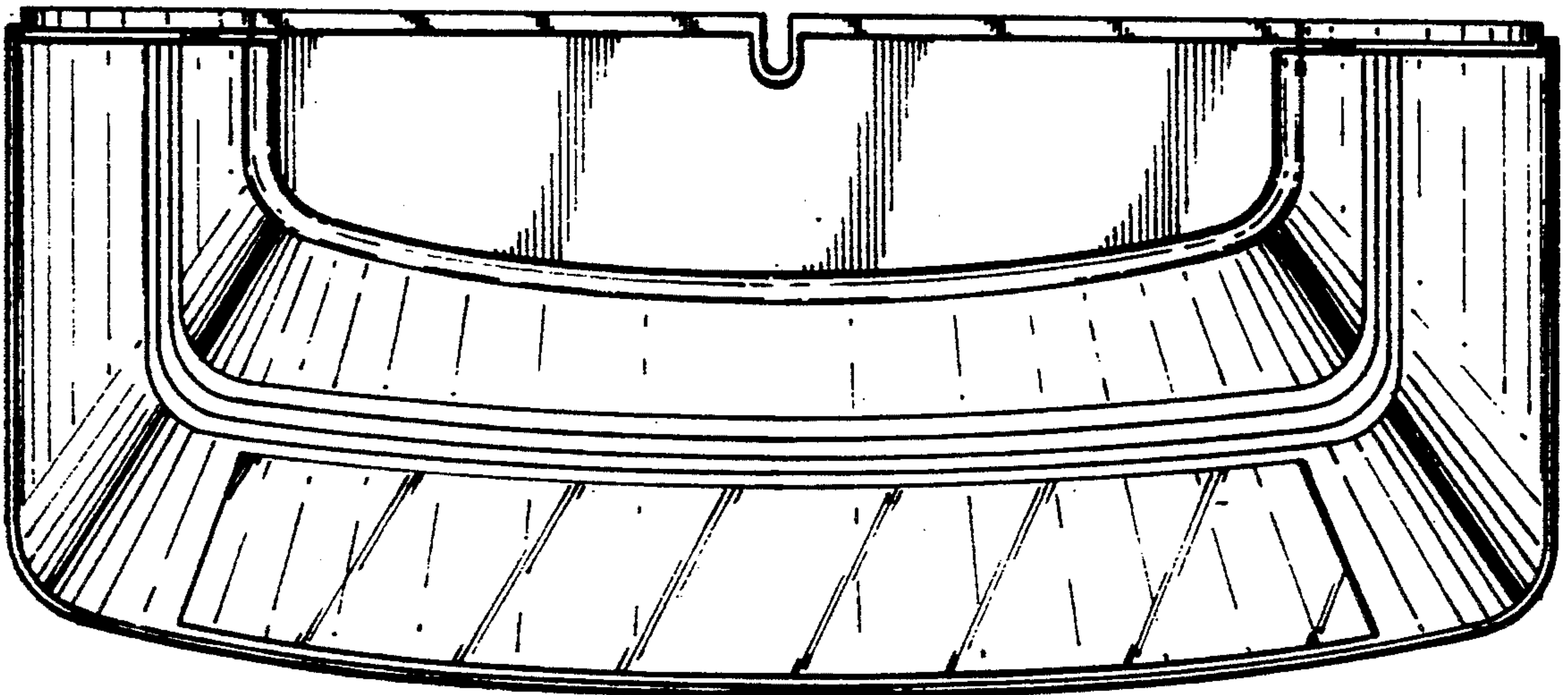

FIG. 3

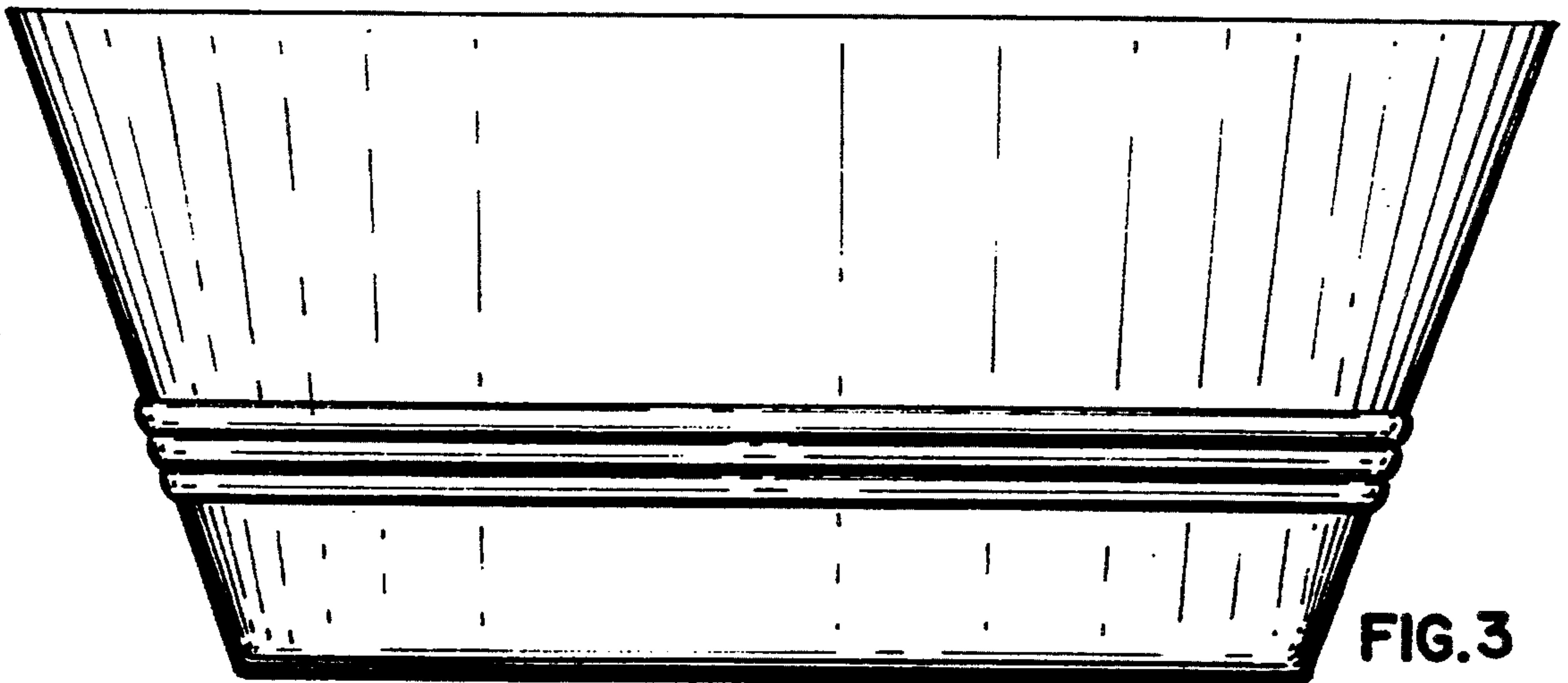

FIG. 4

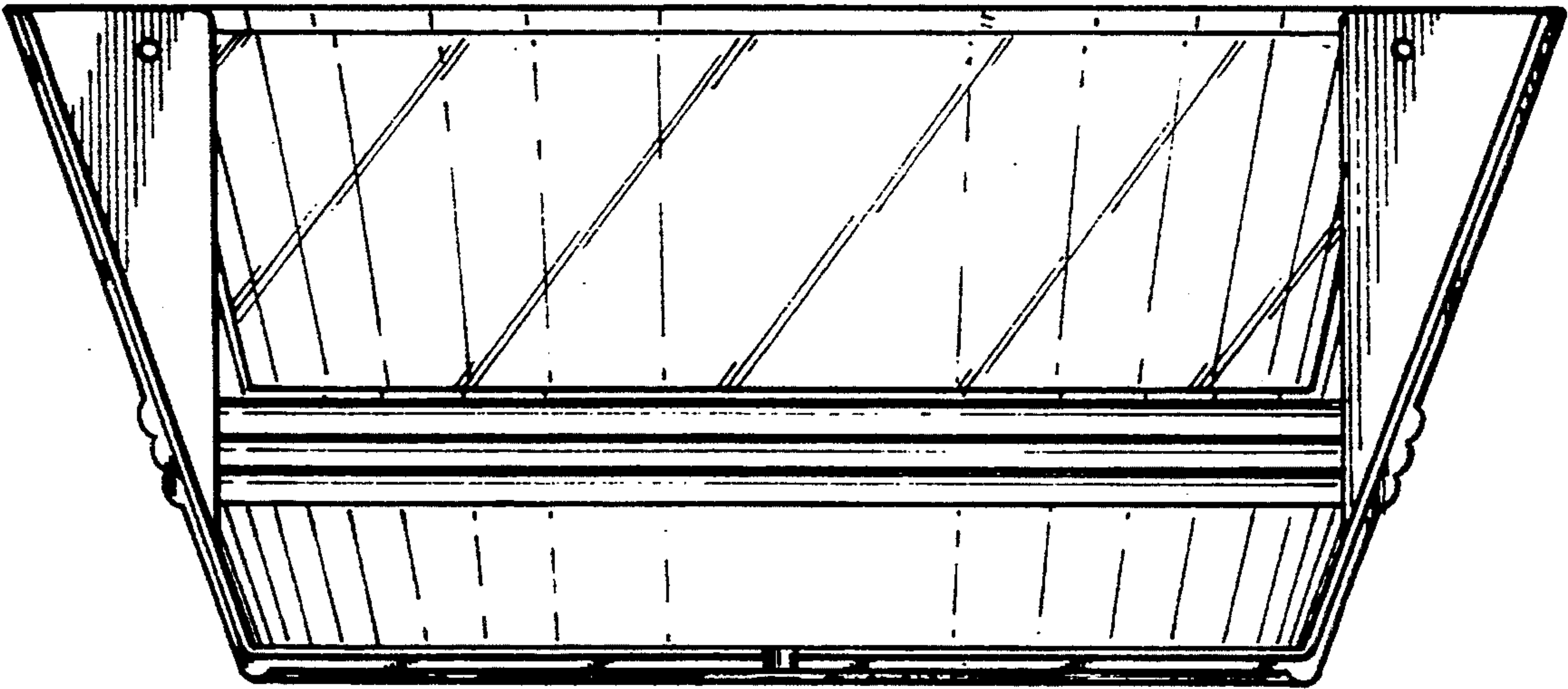

FIG. 5

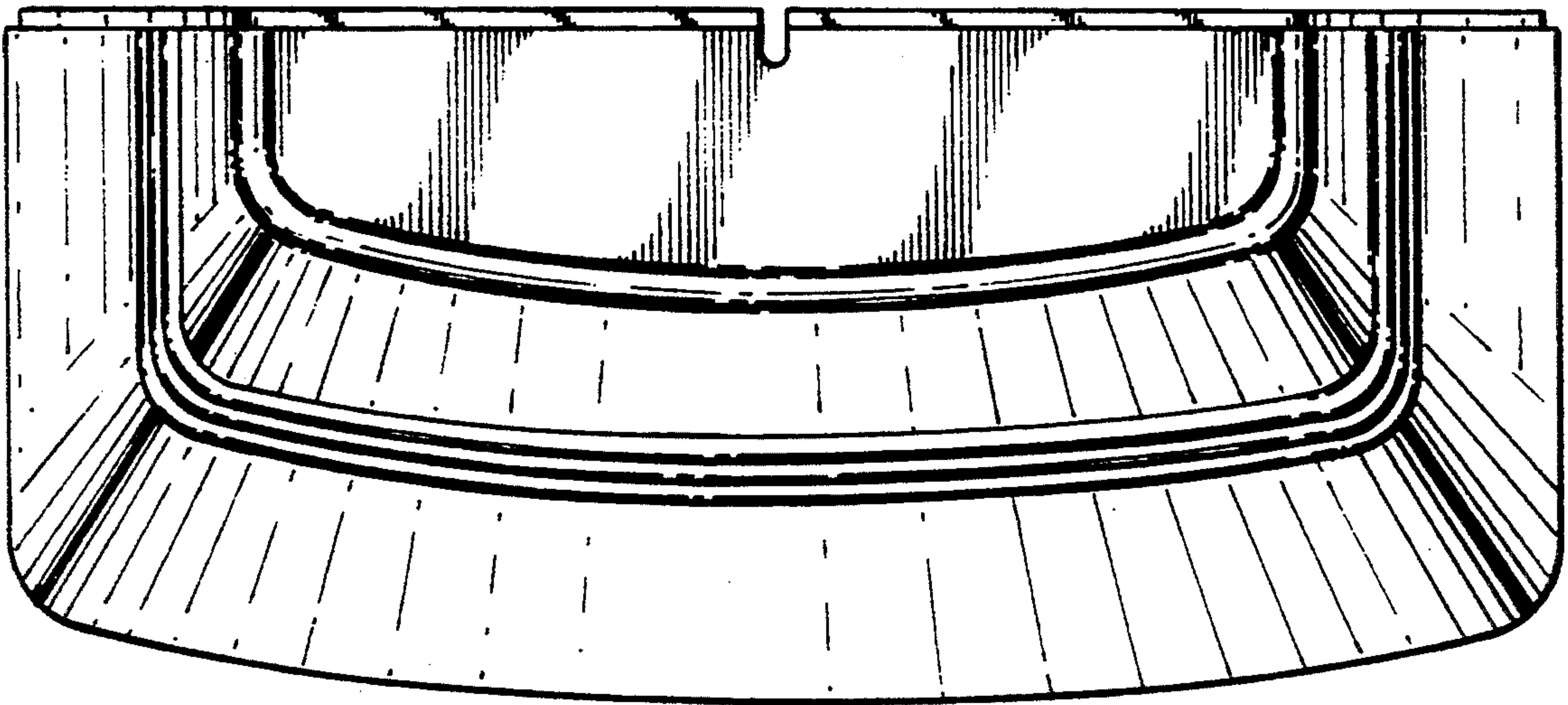

FIG. 6

