



US00D357726S

# United States Patent [19]

Furomoto

[11] Patent Number: **Des. 357,726**

[45] Date of Patent: **\*\* Apr. 25, 1995**

[54] **ROTARY FRAME FOR SPINNING REEL**

[75] Inventor: **Yoshiyuki Furomoto, Osaka, Japan**

[73] Assignee: **Shimano Inc., Osaka, Japan**

[\*] Notice: The portion of the term of this patent subsequent to Jan. 31, 2009 has been disclaimed.

[\*\*] Term: **14 Years**

[21] Appl. No.: **922,943**

[22] Filed: **Jul. 31, 1992**

[52] U.S. Cl. .... **D22/141**

[58] Field of Search ..... D22/141; 242/224, 230, 242/232, 233, 311

[56] **References Cited**

### U.S. PATENT DOCUMENTS

D. 273,975 5/1984 Sakumoto et al. .... D22/141

D. 285,823 9/1986 Inuma et al. .... D22/141  
D. 327,112 6/1992 Myojo ..... D22/141  
D. 329,907 9/1992 Yui ..... D22/141  
5,246,186 9/1993 Sugawara ..... 242/232

*Primary Examiner*—A. Hugo Word  
*Assistant Examiner*—Doris V. Coles  
*Attorney, Agent, or Firm*—Dickstein, Shapiro & Morin

### [57] CLAIM

The ornamental design for a rotary frame for spinning reel, as shown and described.

### DESCRIPTION

FIG. 1 is a top plan view of a rotary frame for spinning reel, showing my new design;  
FIG. 2 is a left side view thereof;  
FIG. 3 is a right side view thereof;  
FIG. 4 is a front view thereof;  
FIG. 5 is a rear view thereof;  
FIG. 6 is a top, front, perspective view thereof; and,  
FIG. 7 is a bottom view thereof.

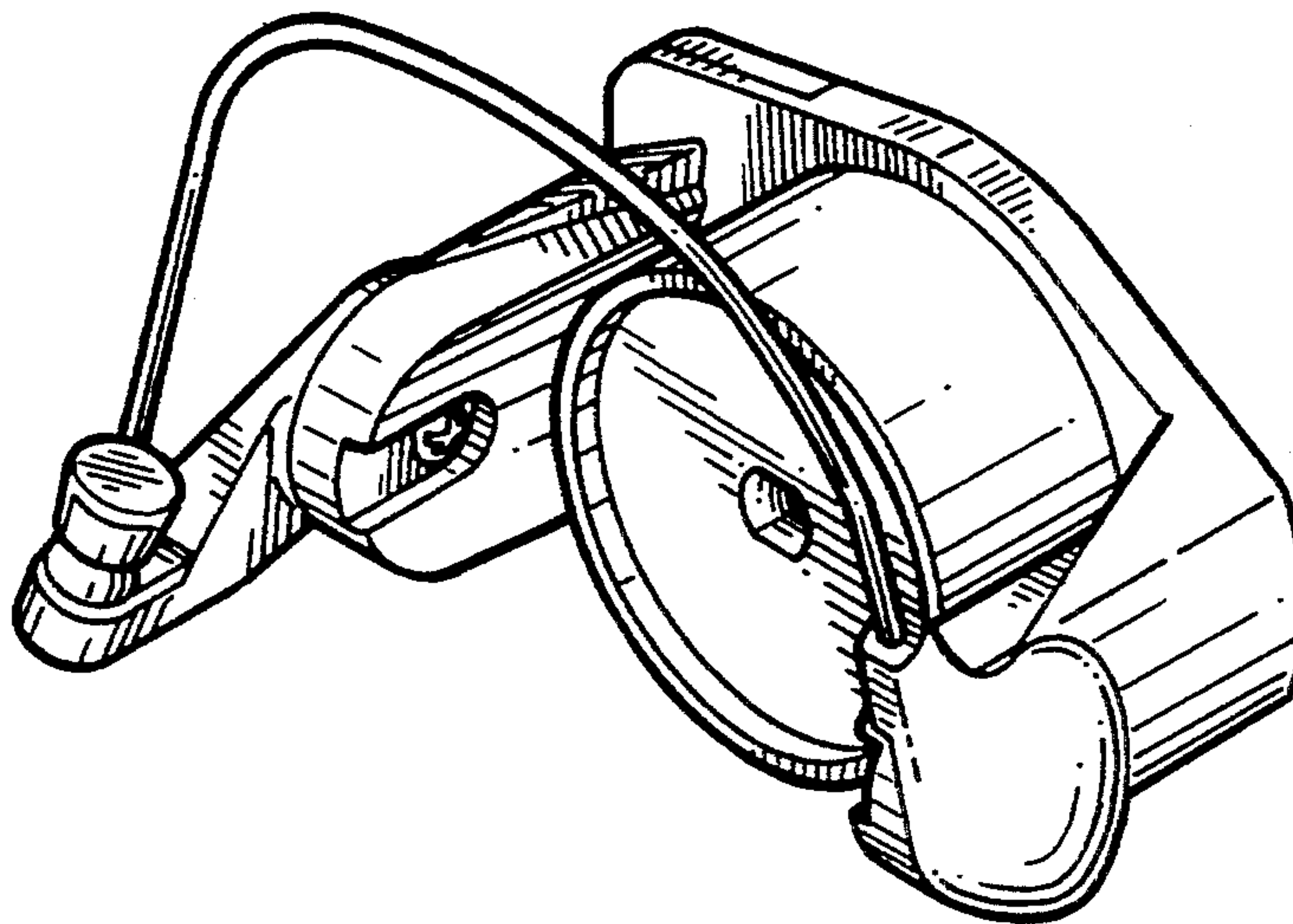

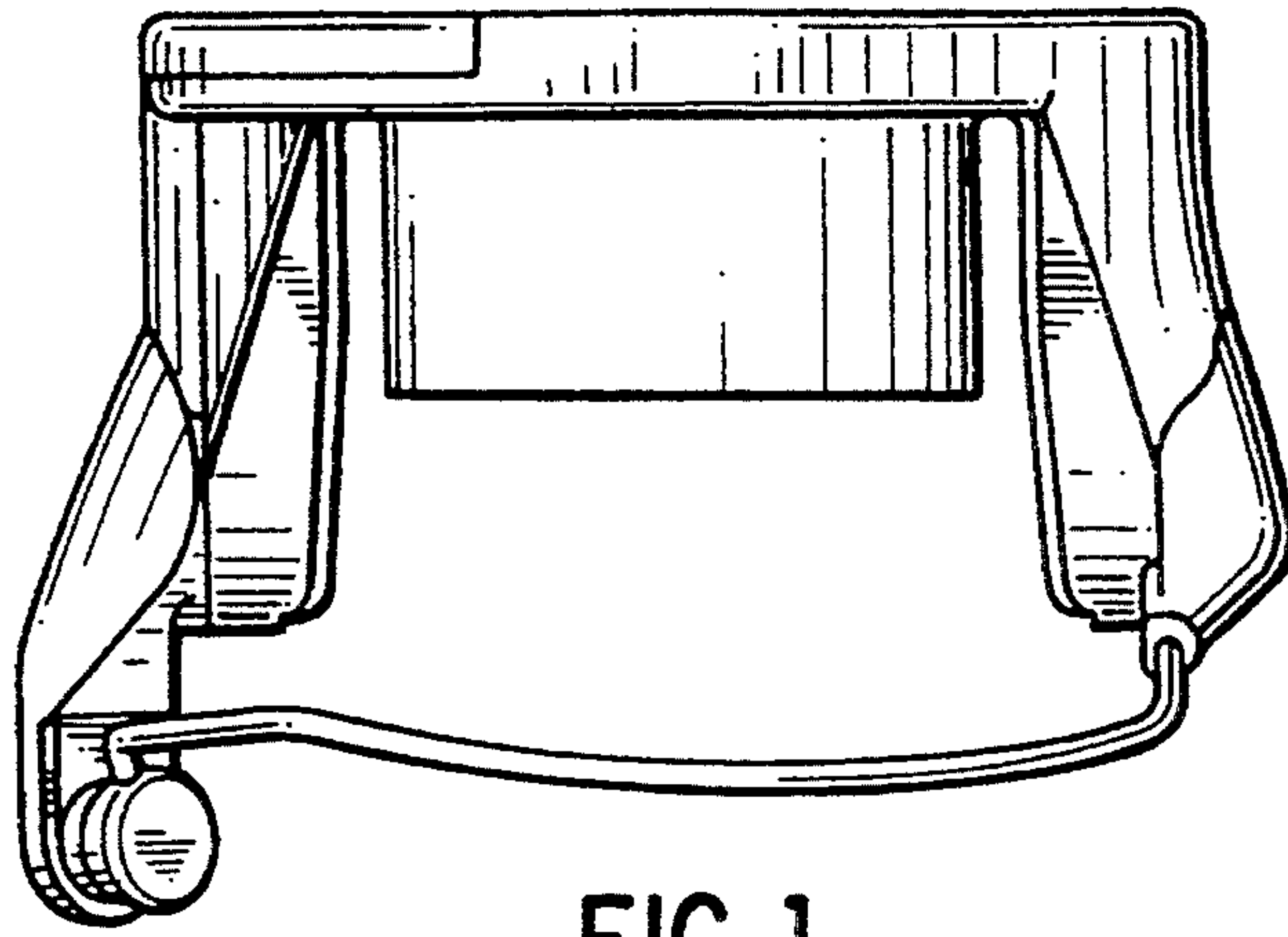

FIG. 1

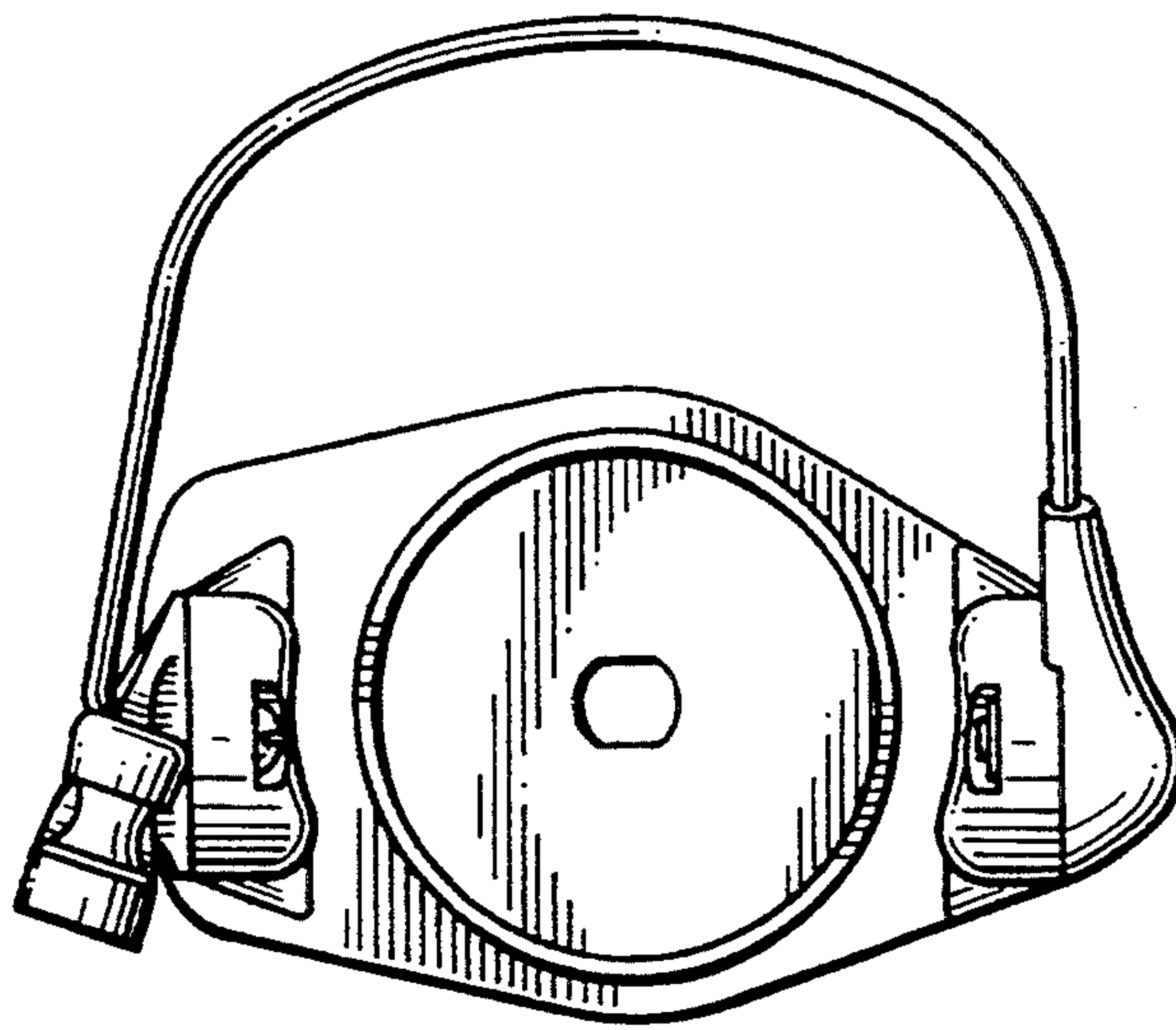

FIG. 4

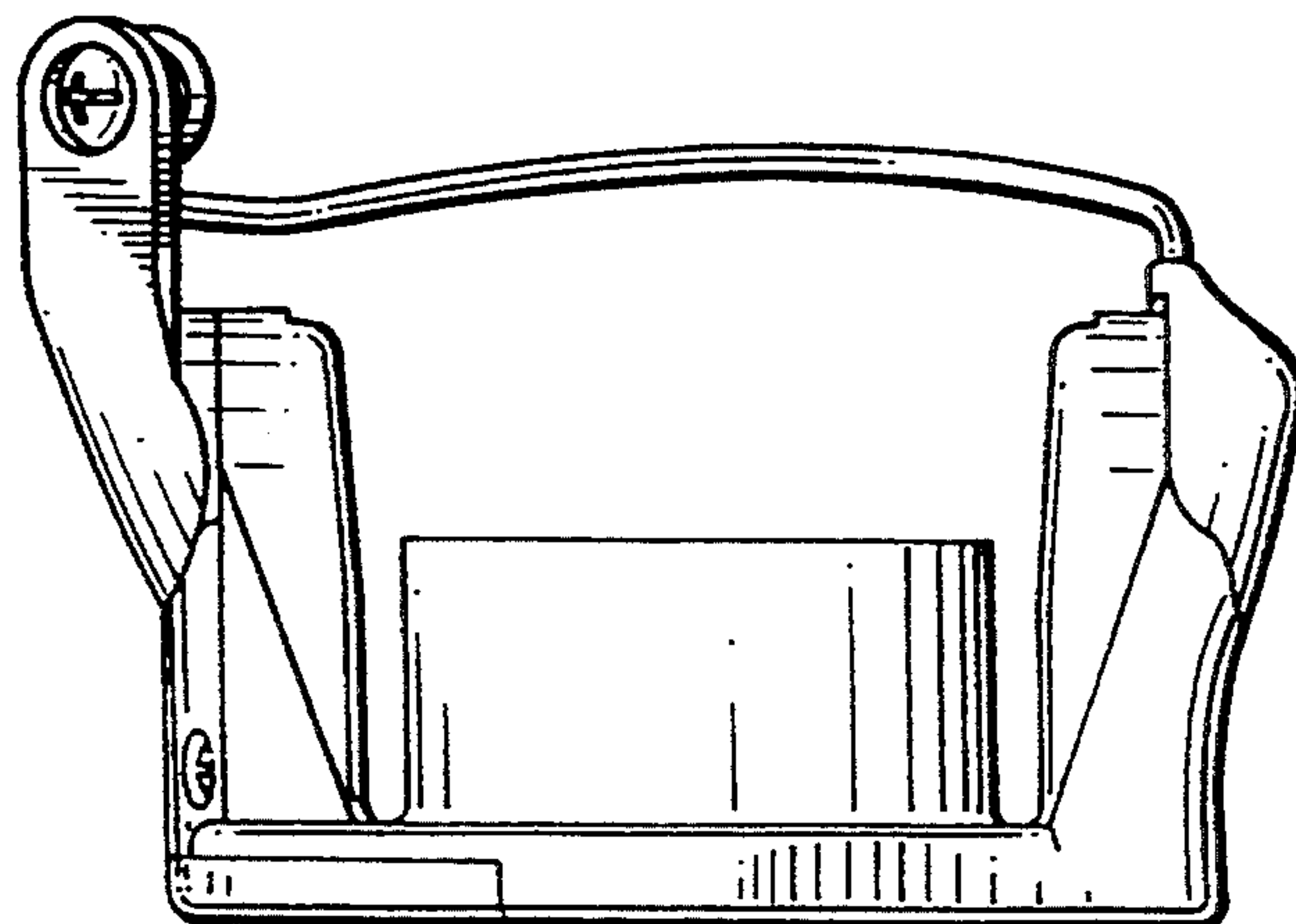

FIG. 7

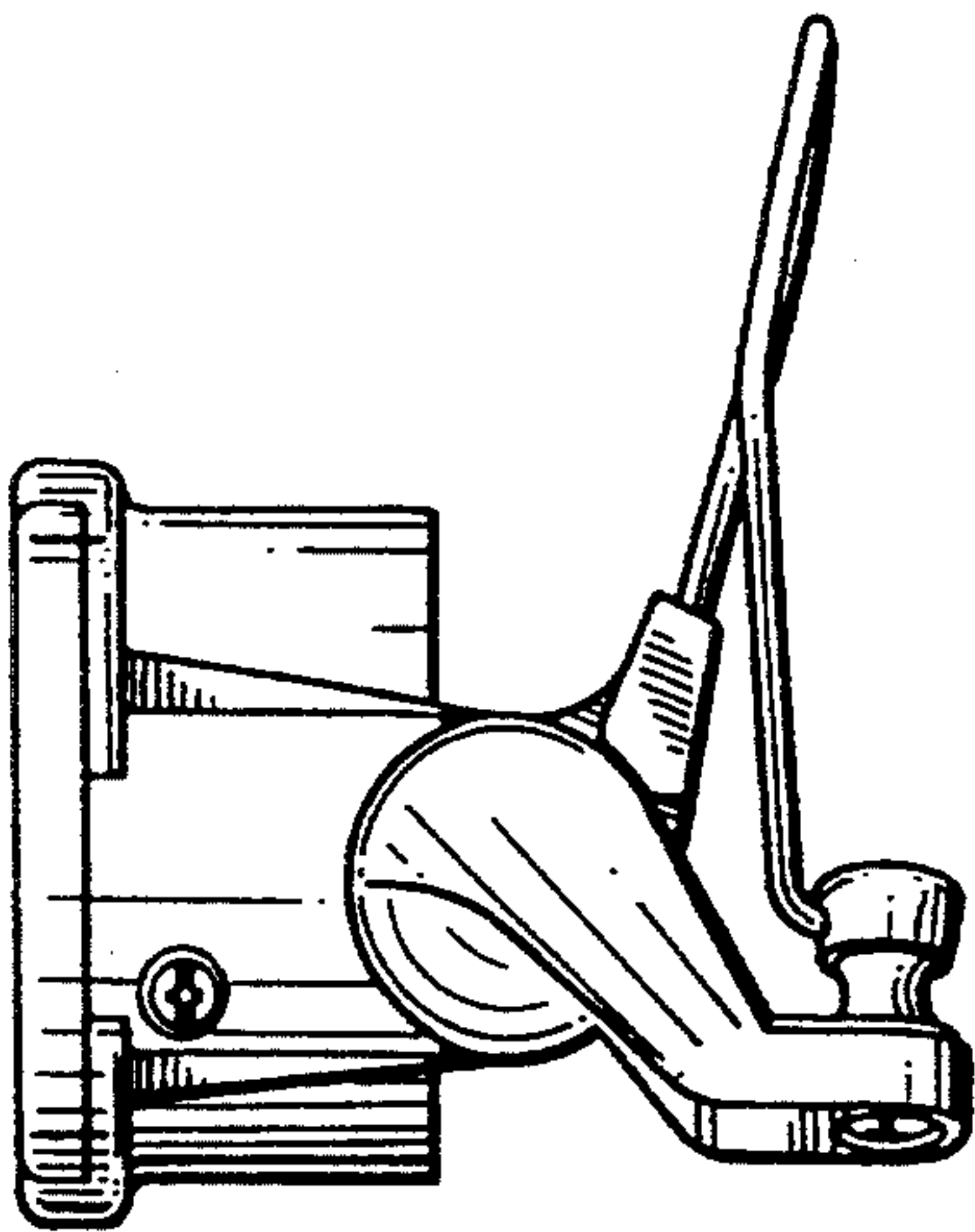

FIG. 2

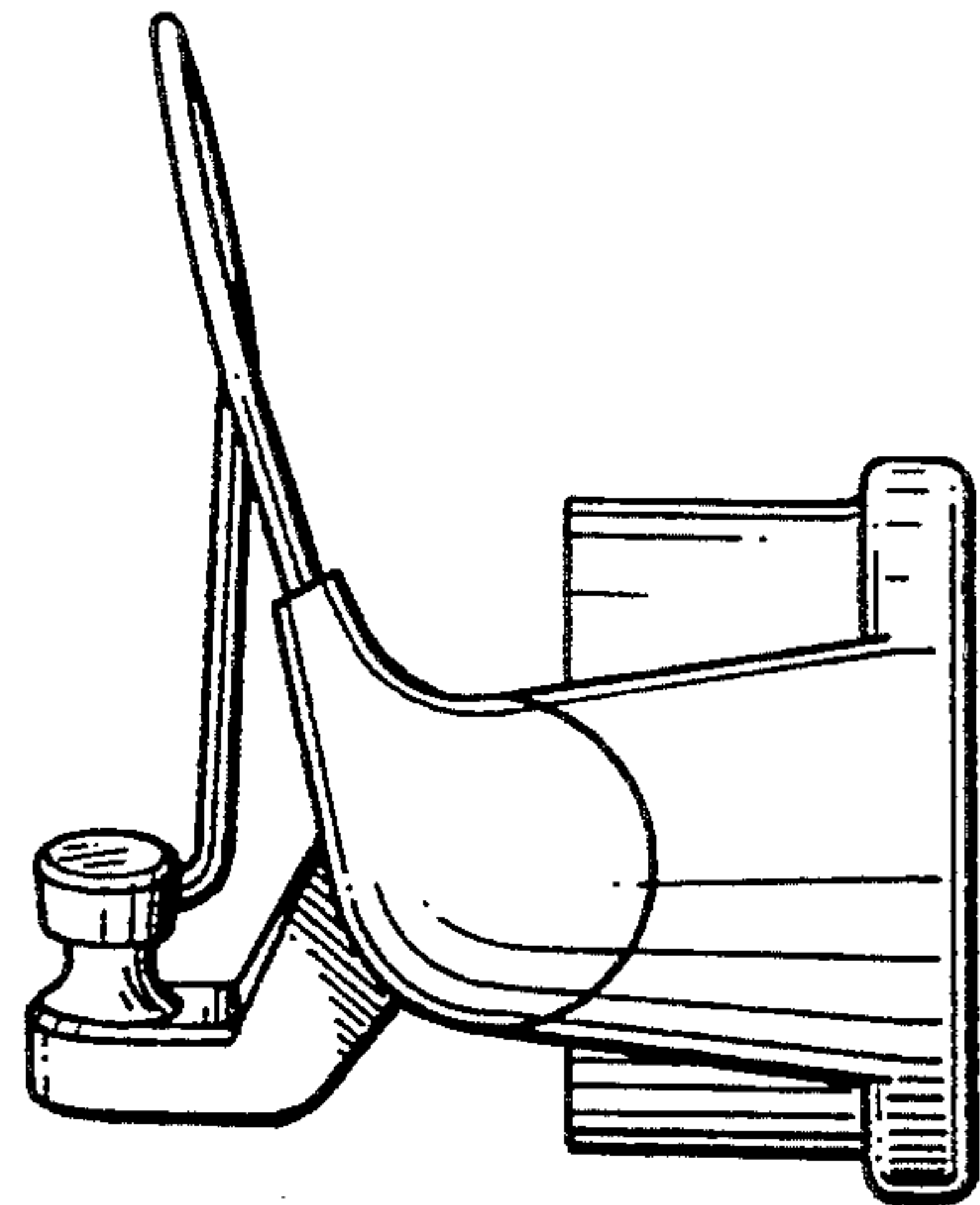

FIG. 3

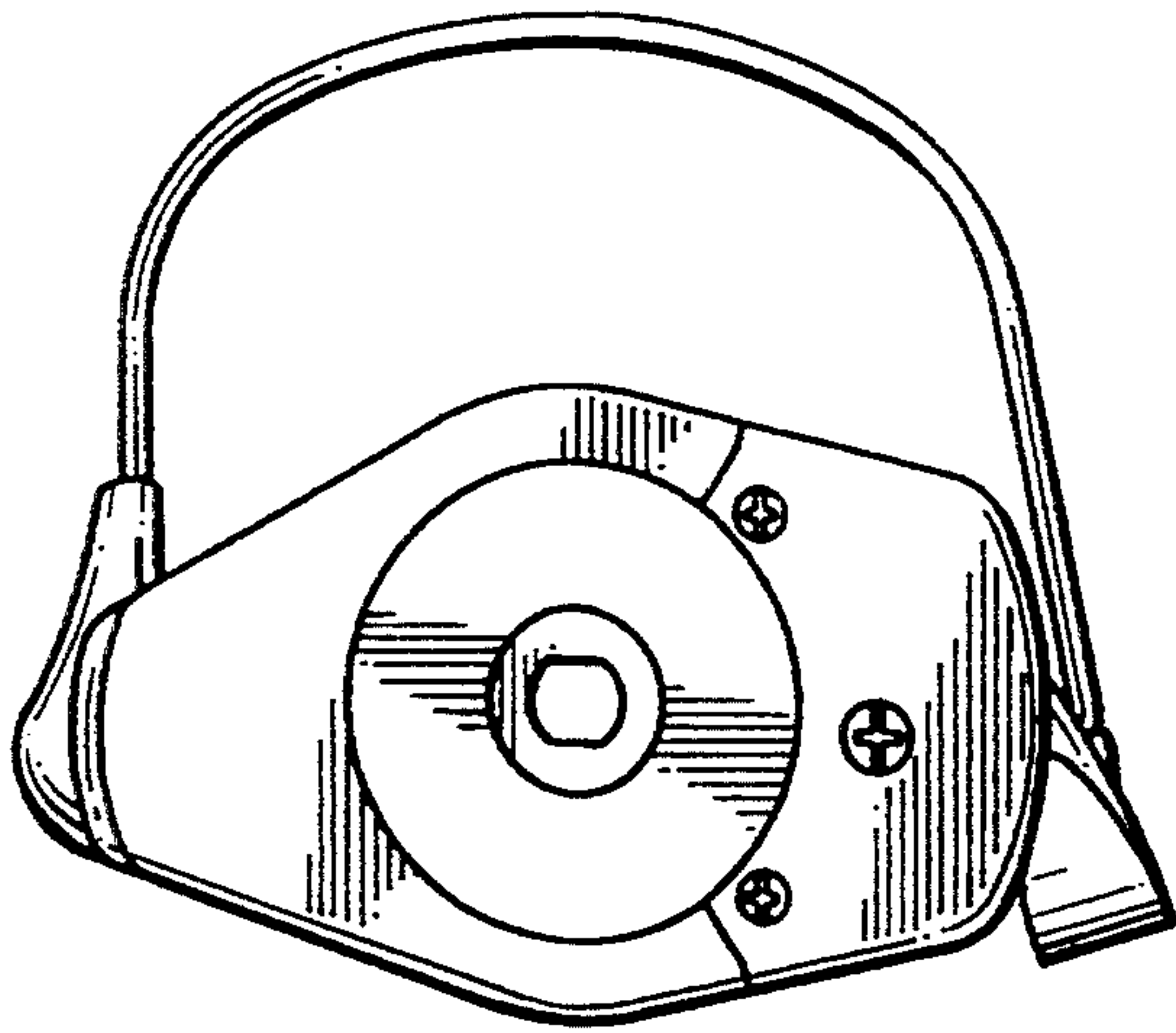

FIG. 5

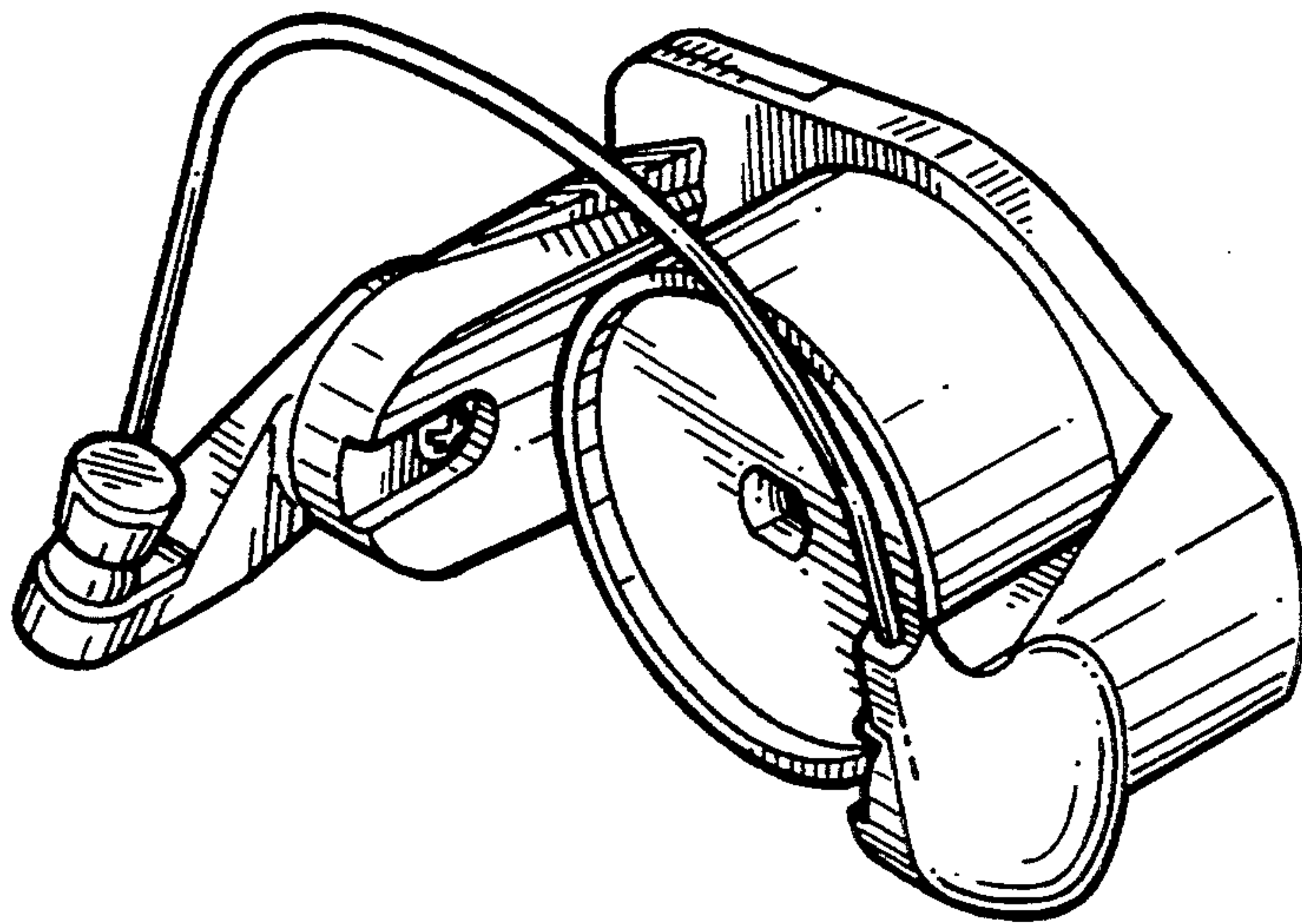

FIG. 6