



US00D357714S

# United States Patent [19]

Ryaa

[11] Patent Number: **Des. 357,714**

[45] Date of Patent: **\*\* Apr. 25, 1995**

[54] STAIRCASE FOR A TOY BUILDING SET

[75] Inventor: **Jan Ryaa, Billund, Denmark**

[73] Assignee: **Interlego AG, Baar, Switzerland**

[\*\*] Term: **14 Years**

[21] Appl. No.: **13,315**

[22] Filed: **Sep. 22, 1993**

[52] U.S. Cl. .... **D21/108; D21/109**

[58] Field of Search ..... **D21/108, 109, 111, 114, D21/121, 123; D25/62, 63; 446/107, 111, 116, 121, 125, 128, 141, 268, 296, 322, 323, 460, 479, 490, 476, 482**

[56] **References Cited**

**U.S. PATENT DOCUMENTS**

- D. 254,920 5/1980 Kimbrough ..... D21/114
- D. 271,524 11/1983 Suckno ..... D25/63
- D. 285,224 8/1986 Olsen ..... D21/108
- D. 285,325 8/1986 Berggreen ..... D21/108

- D. 309,641 7/1990 Olsen ..... D21/109
- 1,173,074 2/1916 Williams ..... D25/63
- 3,996,693 12/1976 Walmer ..... 446/105

*Primary Examiner*—Terry A. Wallace  
*Assistant Examiner*—R. Barkai  
*Attorney, Agent, or Firm*—Kane, Dalsimer, Sullivan, Kurucz, Levy, Eisele and Richard

[57] **CLAIM**

The ornamental design for a staircase for a toy building set, as shown and described.

**DESCRIPTION**

FIG. 1 is a top perspective view of a staircase for a toy building set showing my new design;  
 FIG. 2 is a bottom perspective view thereof;  
 FIG. 3 is a rear elevational view thereof;  
 FIG. 4 is a left side elevational view thereof;  
 FIG. 5 is a front elevational view thereof;  
 FIG. 6 is a right side elevational view thereof;  
 FIG. 7 is a top plan view thereof; and,  
 FIG. 8 is a bottom plan view thereof.

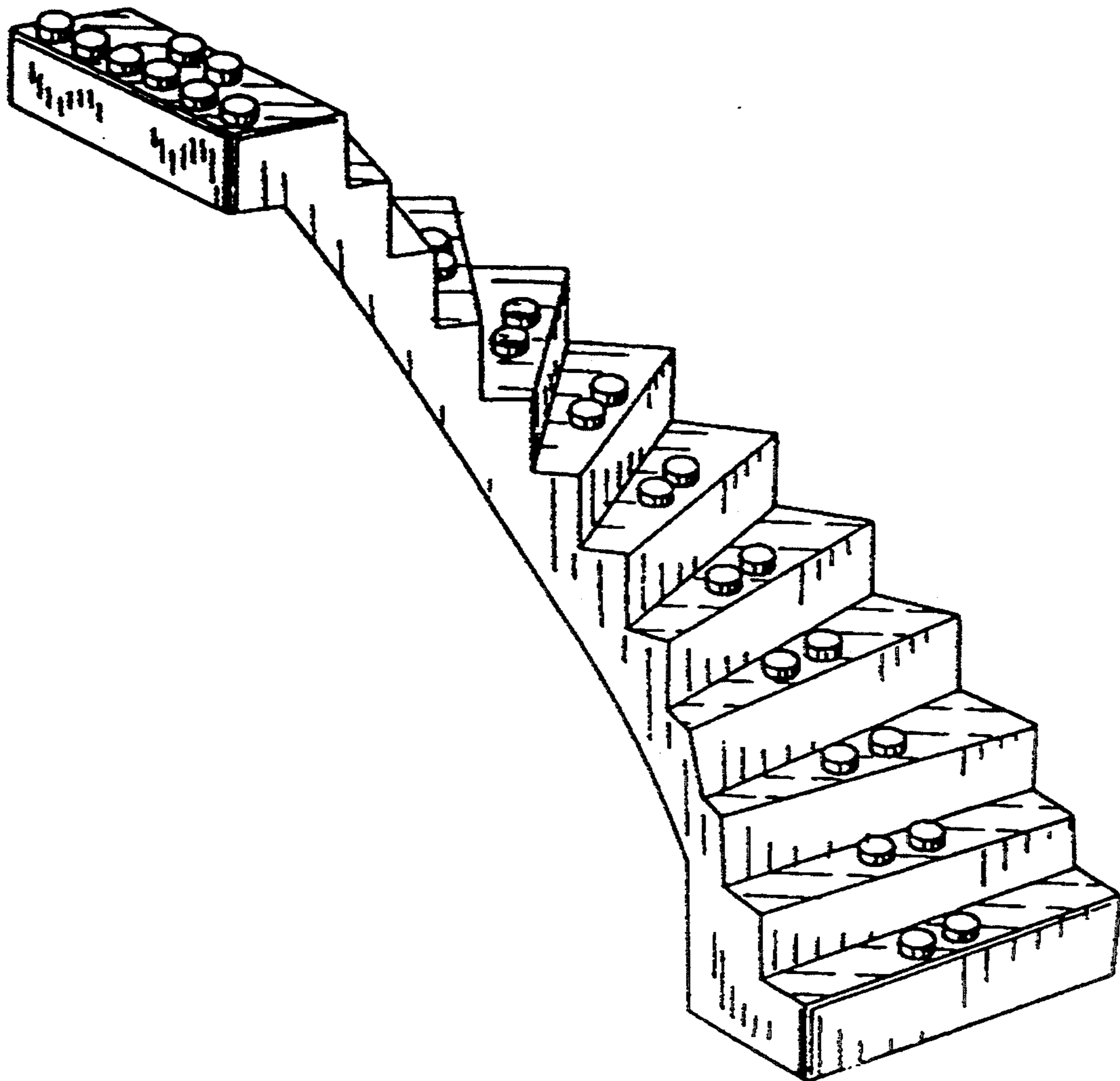

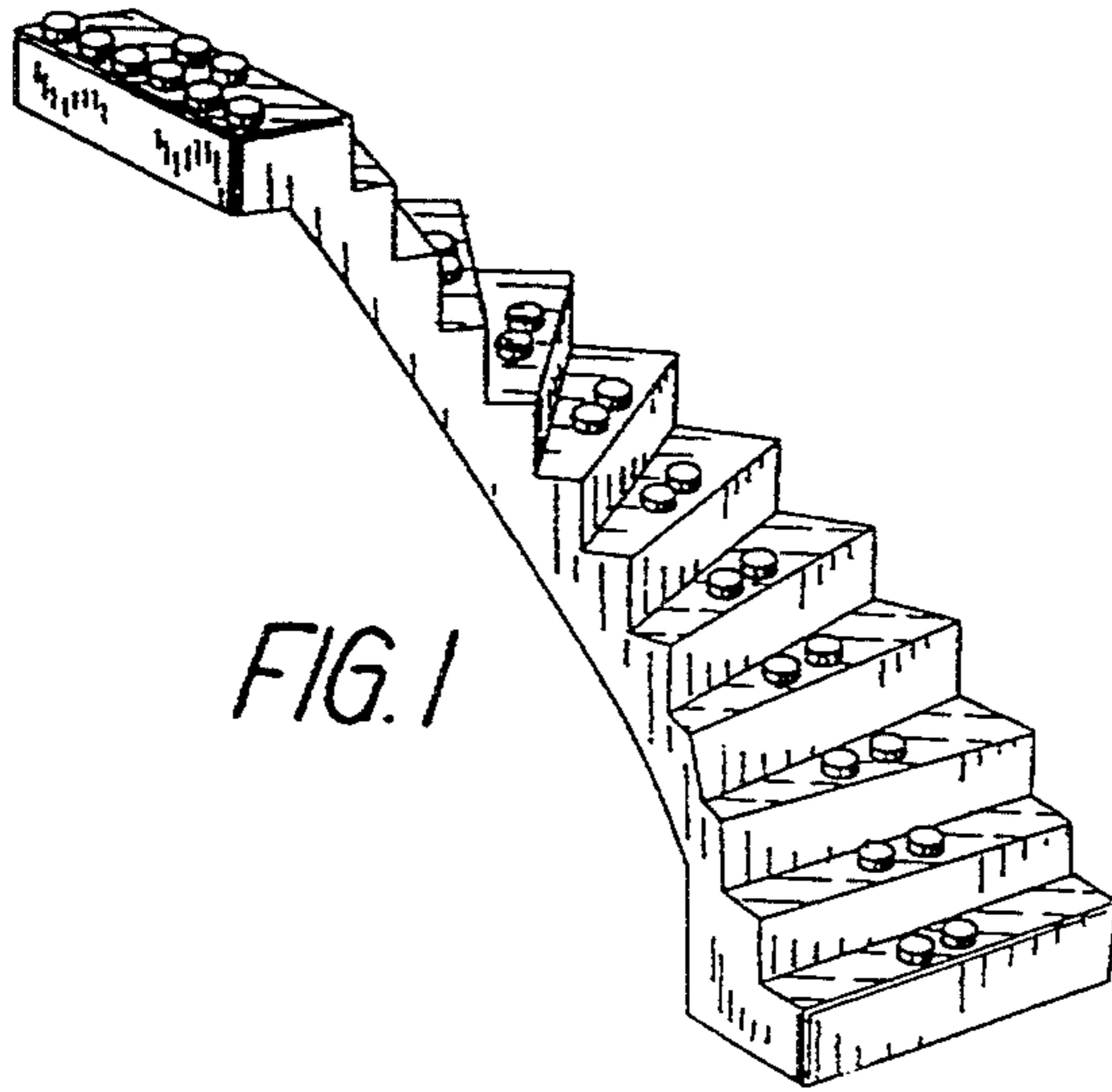

FIG. 1

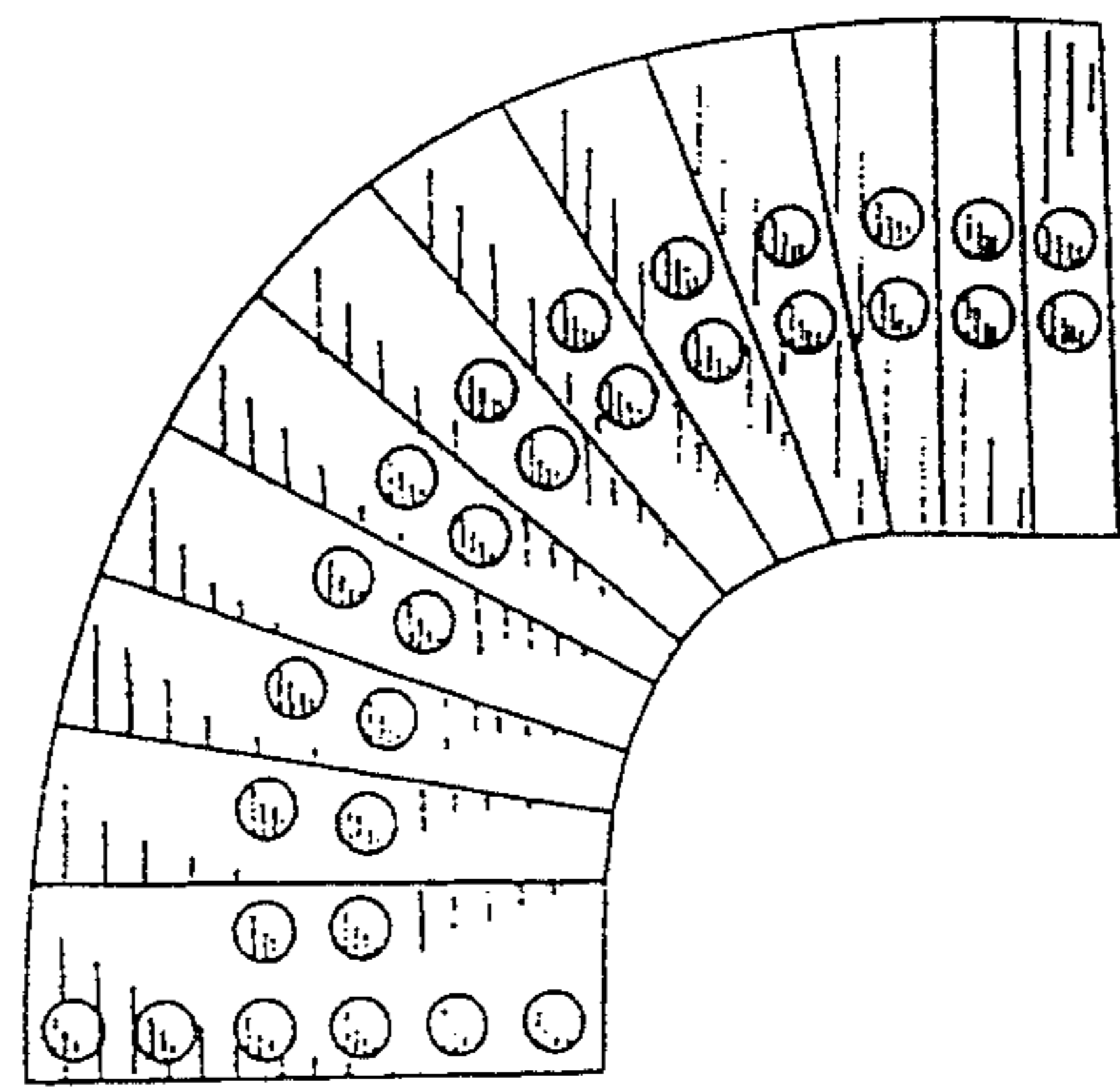

FIG. 7

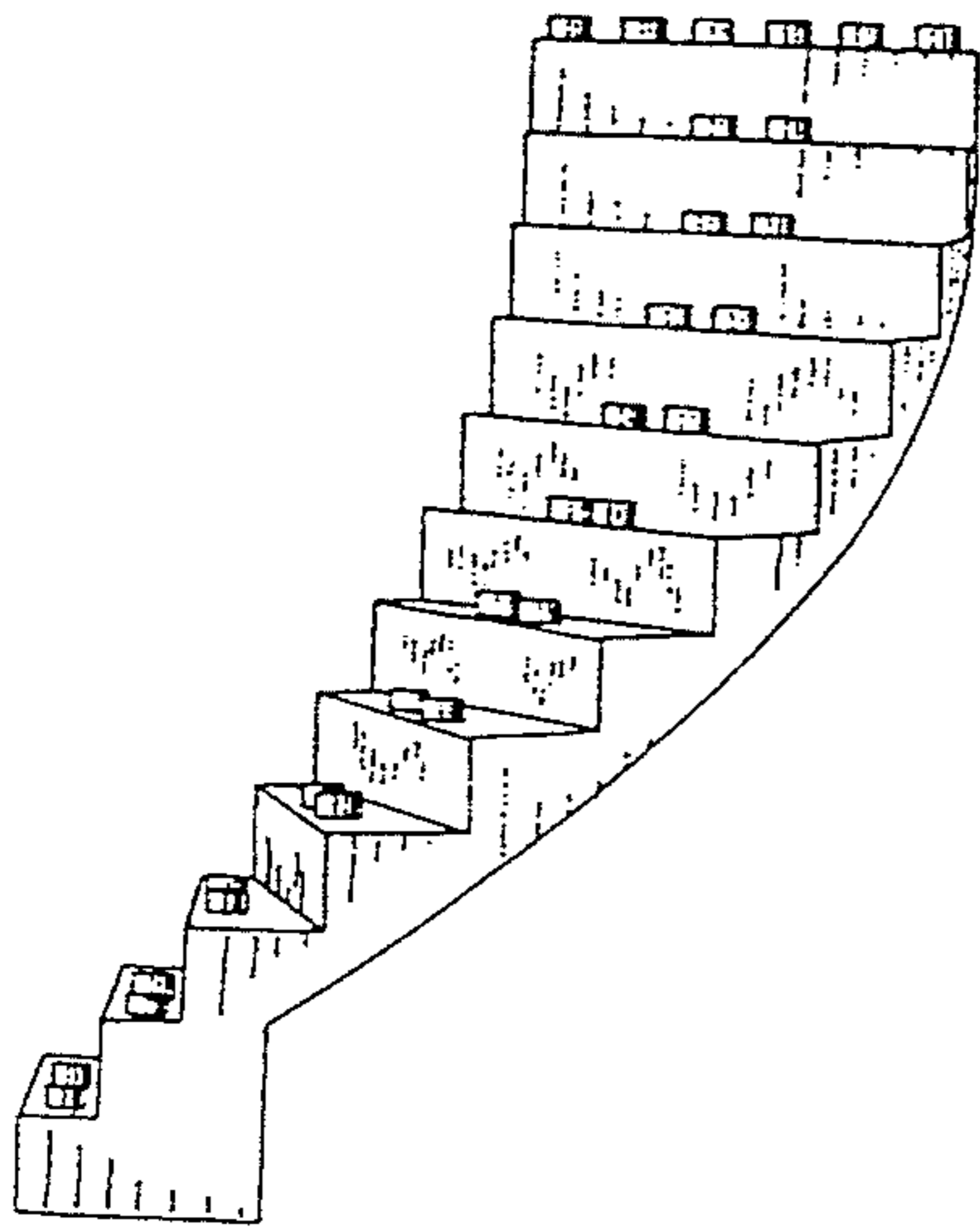

FIG. 4



FIG. 2

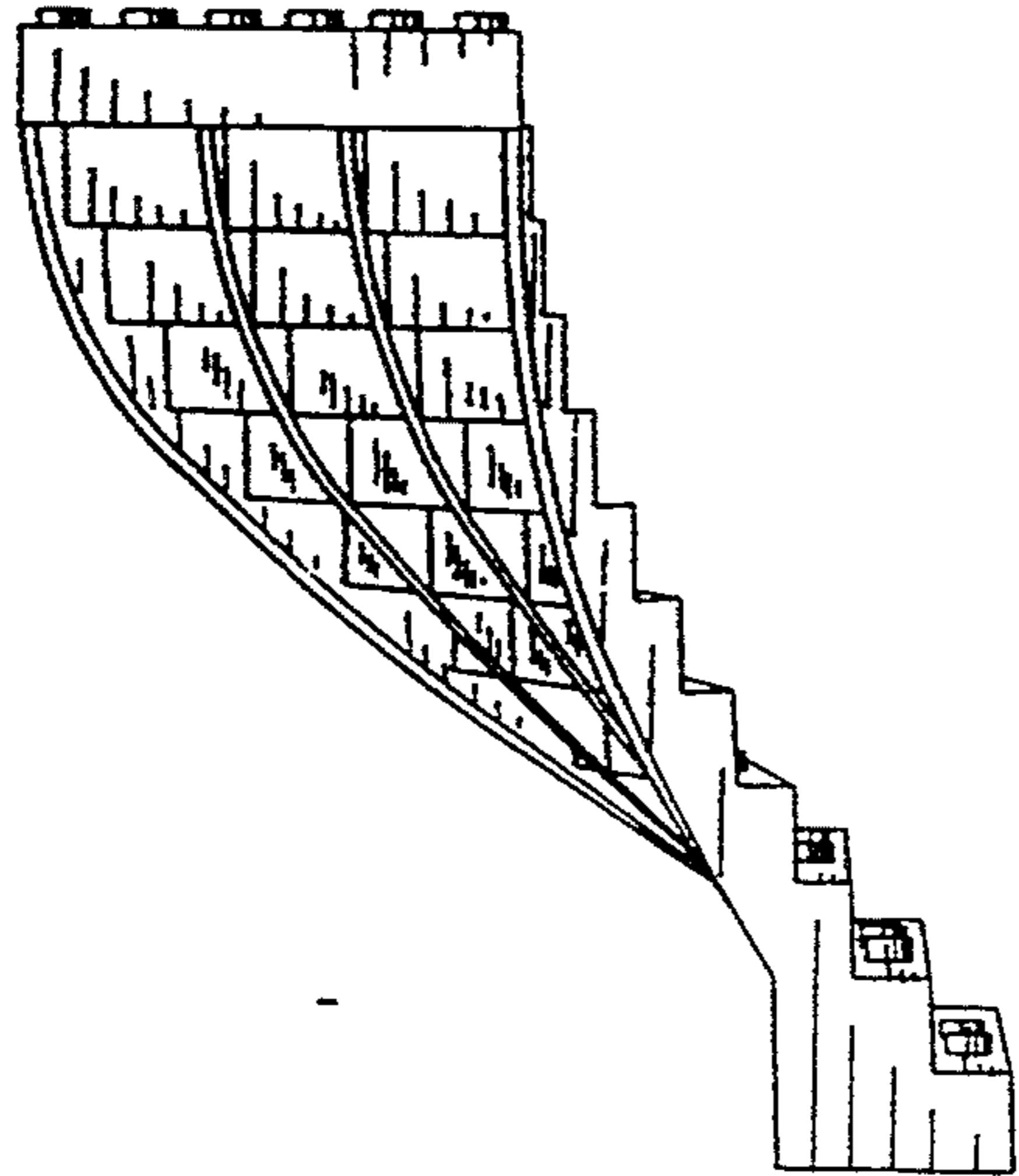

FIG. 6

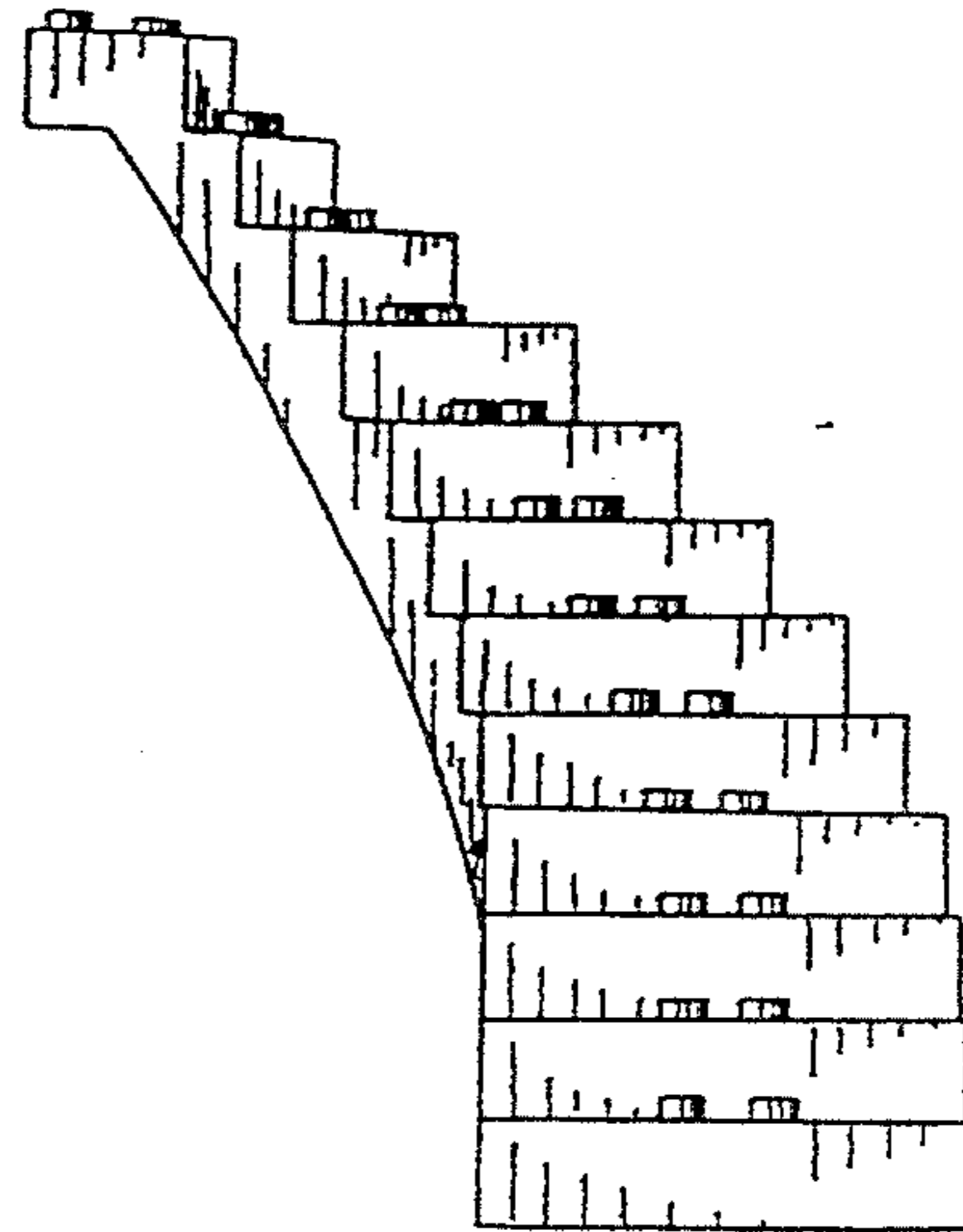

FIG. 5

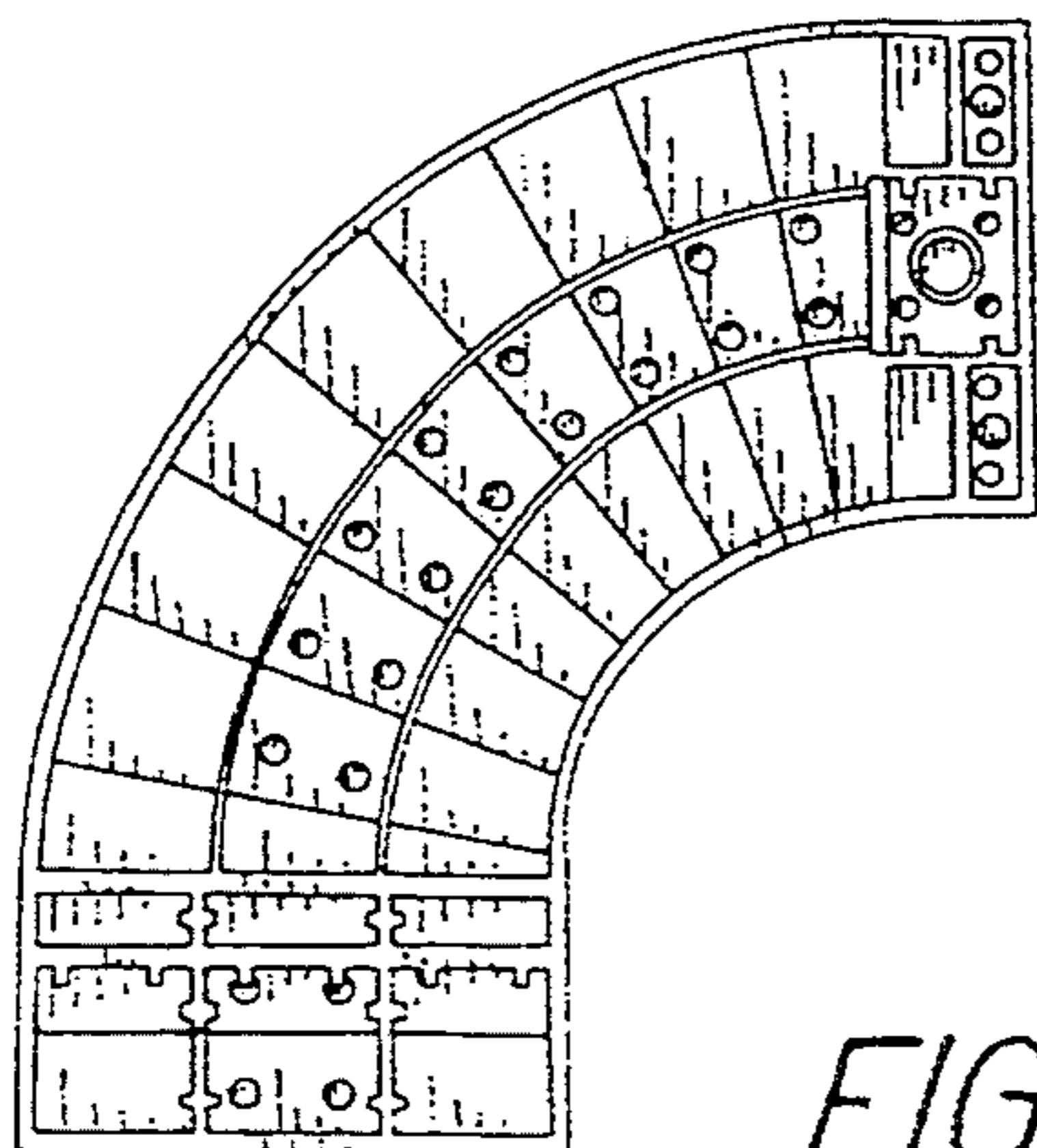

FIG. 8

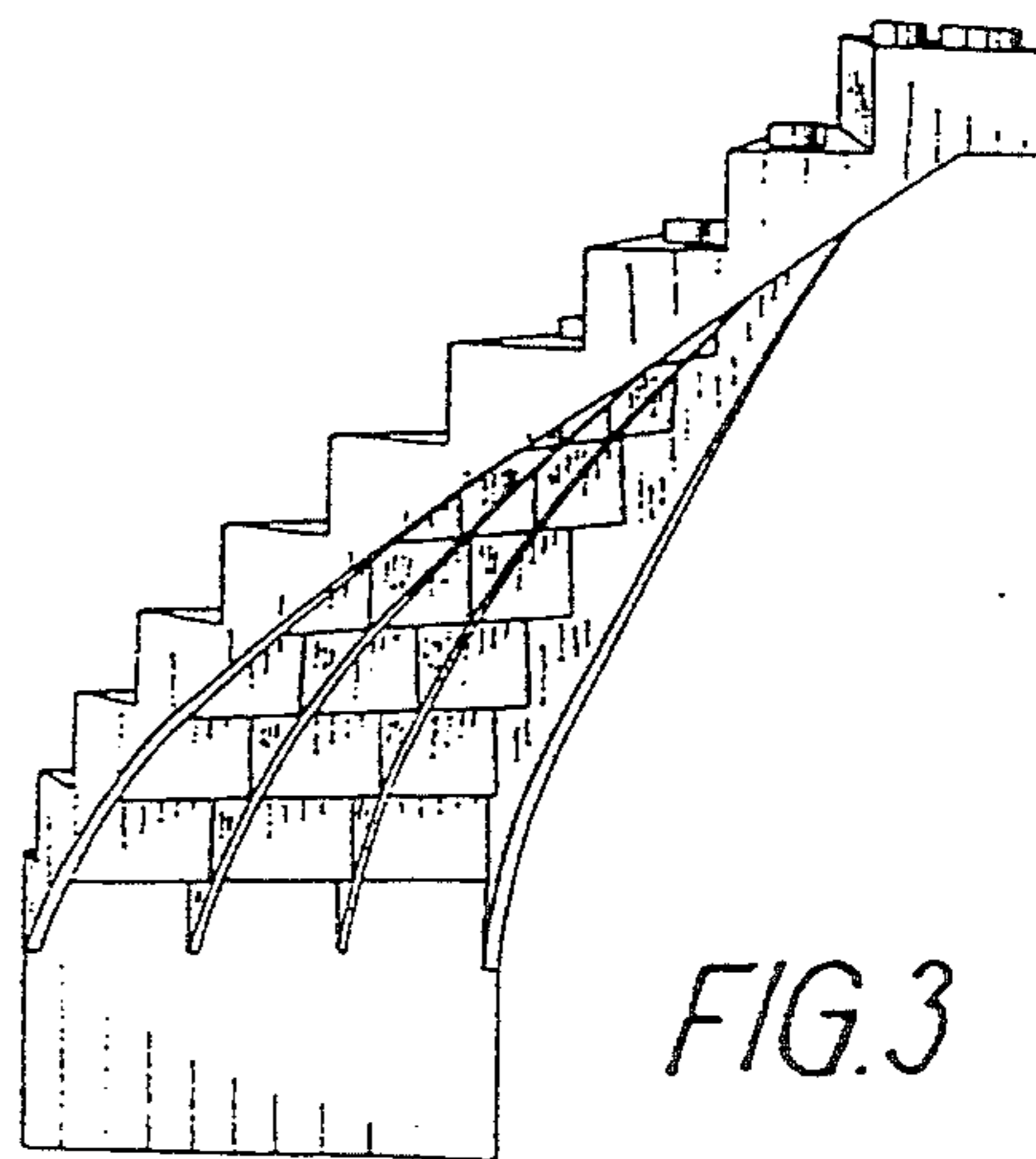

FIG. 3