



US00D357702S

United States Patent [19]

[11] Patent Number: **Des. 357,702**

Green et al.

[45] Date of Patent: **** Apr. 25, 1995**

[54] CARD FILE

[75] Inventors: **Patrick M. Green**, Maryville; **Robert R. Huerto**, Farragut, both of Tenn.

[73] Assignee: **Rubbermaid Office Products Inc.**, Maryville, Tenn.

[**] Term: **14 Years**

[21] Appl. No.: **16,006**

[22] Filed: **Dec. 3, 1993**

[52] U.S. Cl. **D19/75; D19/76; D19/90; D6/634**

[58] Field of Search **D6/632, 634; D9/423, D9/425, 420, 424, 428; D19/65, 75, 76, 78, 86, 90, 91, 95, 99, 100; 206/215, 444, 425, 387, 561; 211/10, 11, 45, 50, 55**

[56] References Cited

U.S. PATENT DOCUMENTS

D. 170,165	8/1953	Roop	D19/76
D. 172,296	5/1954	Nelson	D9/423
D. 217,080	3/1970	Fleming	D3/281
D. 230,569	3/1974	Fallowfield	D9/423
D. 249,590	9/1978	Berkman	D6/631
D. 266,544	10/1982	Crutchfield	D3/72
D. 267,836	2/1983	Benichou	D3/78
D. 269,467	6/1983	Mann	D9/423 X
D. 288,938	3/1987	Klodt	D19/76
D. 298,515	11/1988	Pennell	D9/423
D. 299,474	1/1989	Klodt	D19/76
D. 313,816	1/1991	Evans	D19/75
D. 325,930	5/1992	Breen	D19/76
D. 327,913	7/1992	Ancona et al.	D19/75
D. 328,313	7/1992	Evenson	D19/75
D. 335,575	5/1993	Suwa	D19/90 X

OTHER PUBLICATIONS

Catalog page, Files; Exposures, 2800 Hoover Road, Stevens Point, Wis. 54481. It is believed that the product depicted herein has been on sale for more than one

(1) year prior to the application date of this instant application. (Dec. 3, 1992).

Catalog page, Photo archive; Exposures, 2800 Hoover Road, Stevens Point, Wis. 54481. It is believed that the product depicted herein has been on sale for more than one (1) year prior to the application date of this instant application. (Dec. 3, 1992).

Catalog page, Photo organizer; Exposures, 2800 Hoover Road, Stevens Point, Wis. 54481. It is believed that the product depicted herein has been on sale for more than one (1) year prior to the application date of this instant application. (Dec. 3, 1992).

Primary Examiner—Martie Thompson

Attorney, Agent, or Firm—Richard B. O'Planick; Lisa B. Riedesel

[57] CLAIM

The ornamental design for a card file, as shown and described.

DESCRIPTION

FIG. 1 is a top left front perspective view of a card file showing our new design;

FIG. 2 is a front elevational view thereof;

FIG. 3 is a rear elevational view thereof;

FIG. 4 is a left side elevational view thereof; the right side elevational view being a mirror image;

FIG. 5 is a top plan view thereof;

FIG. 6 is a bottom plan view thereof;

FIG. 7 is a top left front perspective view of the alternate embodiment of a card file showing our new design;

FIG. 8 is a front elevational view of the alternate embodiment;

FIG. 9 is a rear elevational view of the alternate embodiment;

FIG. 10 is a left side elevational view of the alternate embodiment; the right side elevational view being a mirror image;

FIG. 11 is a top plan view of the alternate embodiment; and,

FIG. 12 is a bottom plan view of the alternate embodiment.

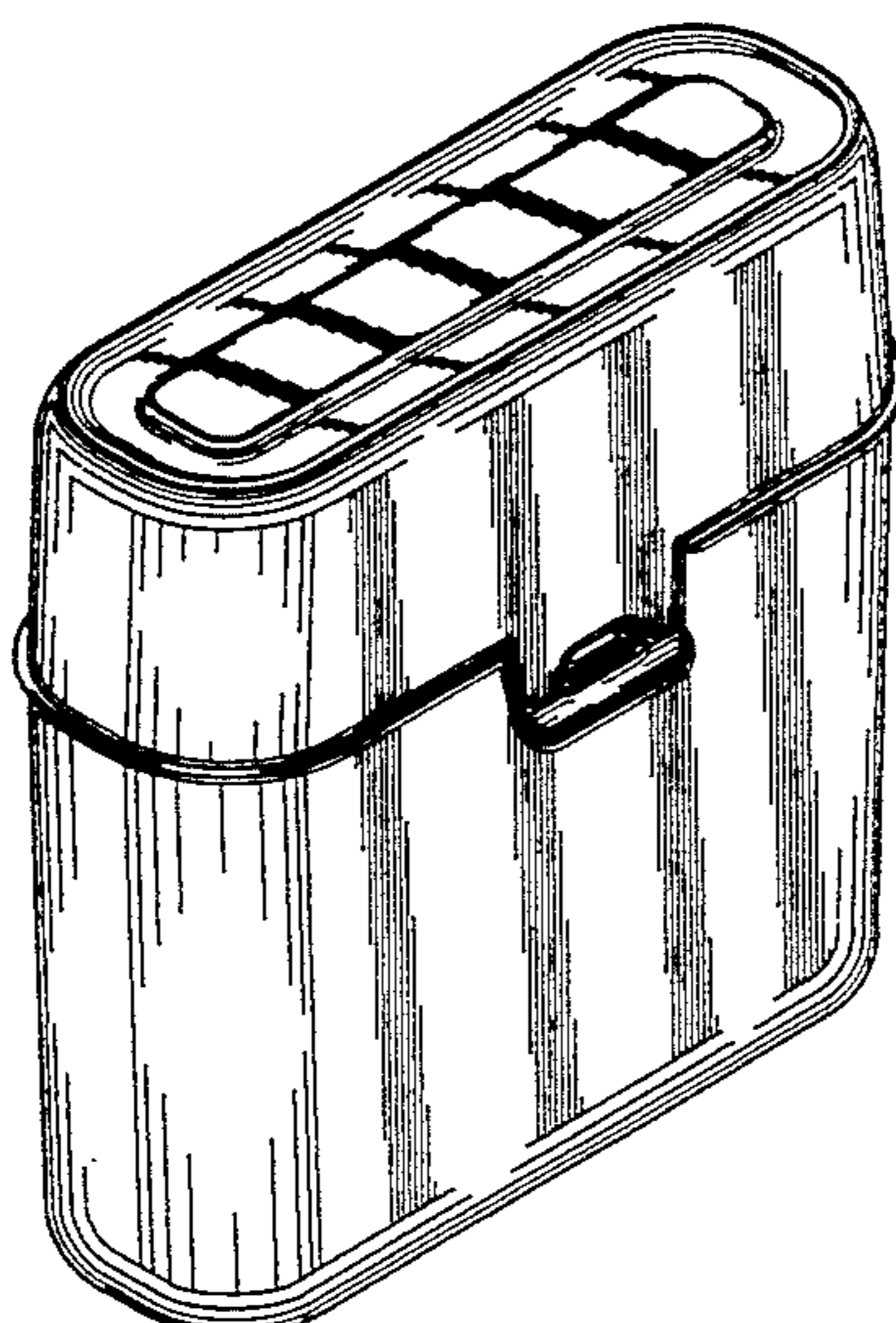

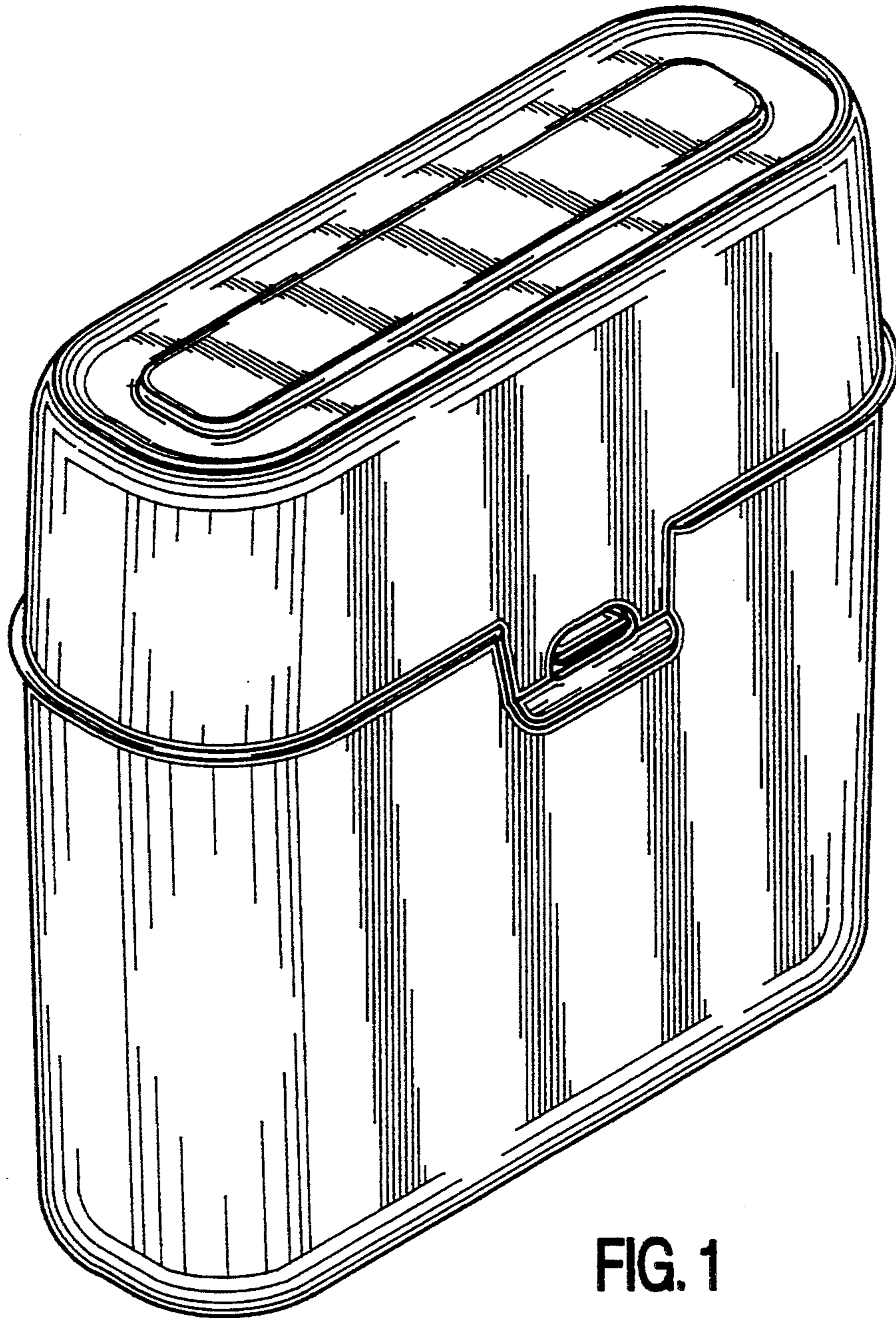

FIG. 1

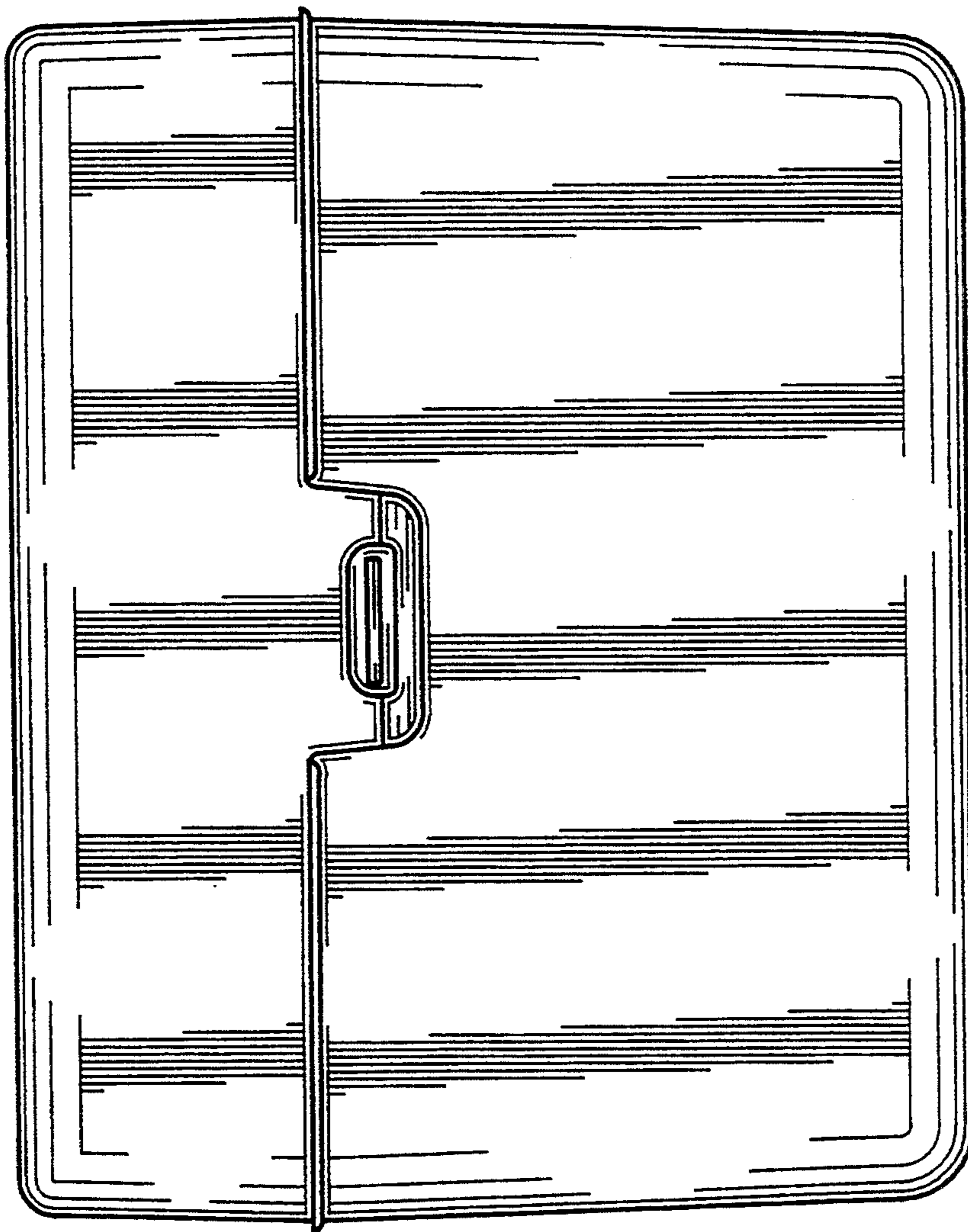

FIG. 2

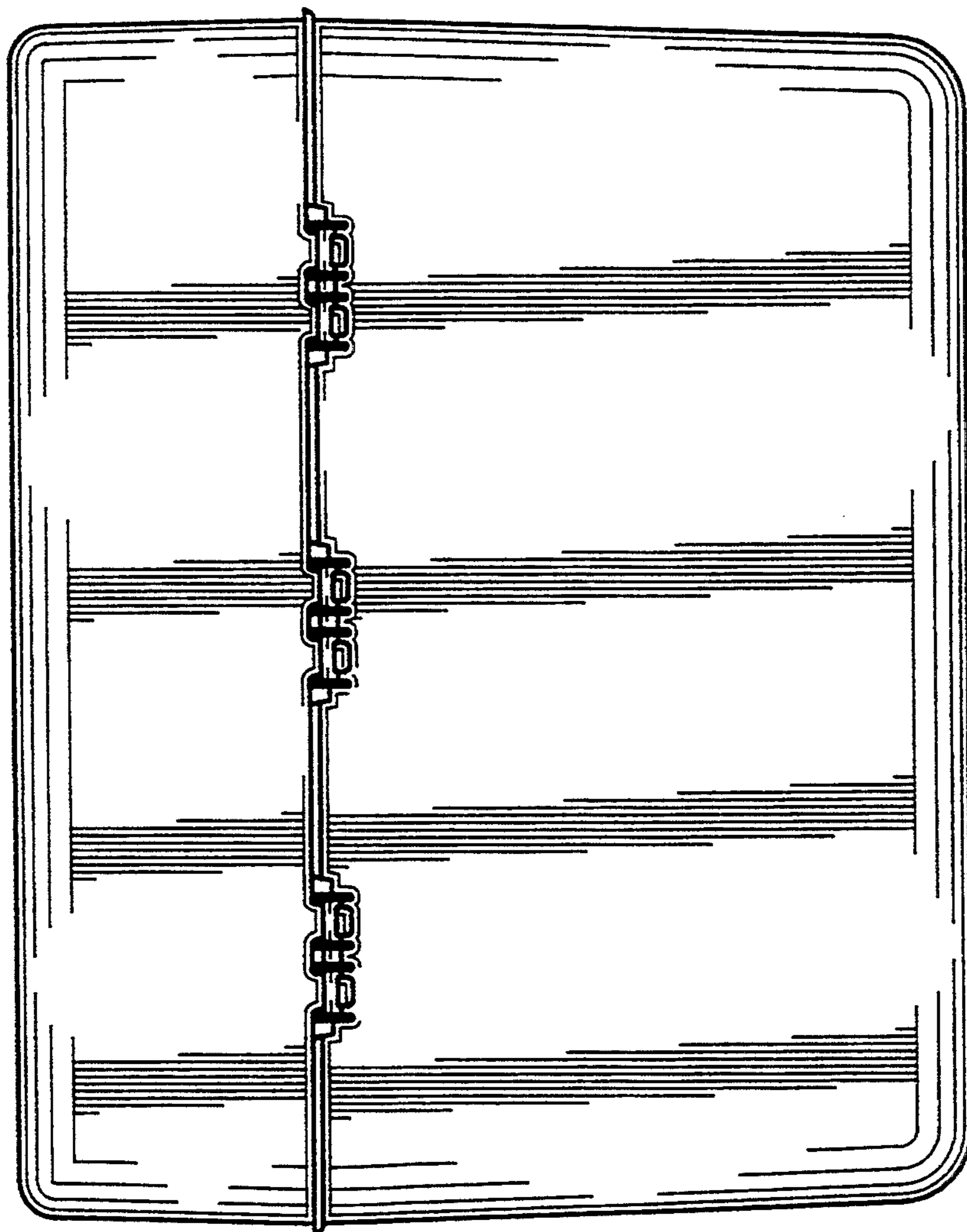

FIG. 3

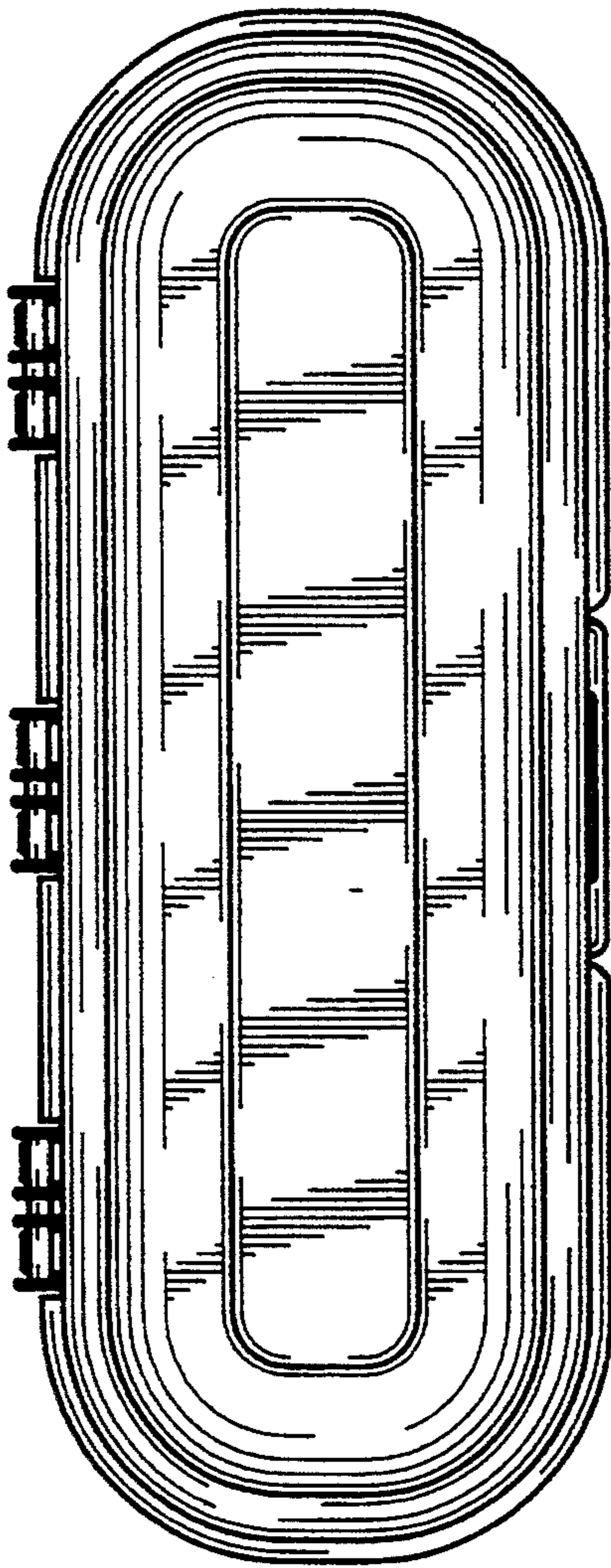

FIG. 5

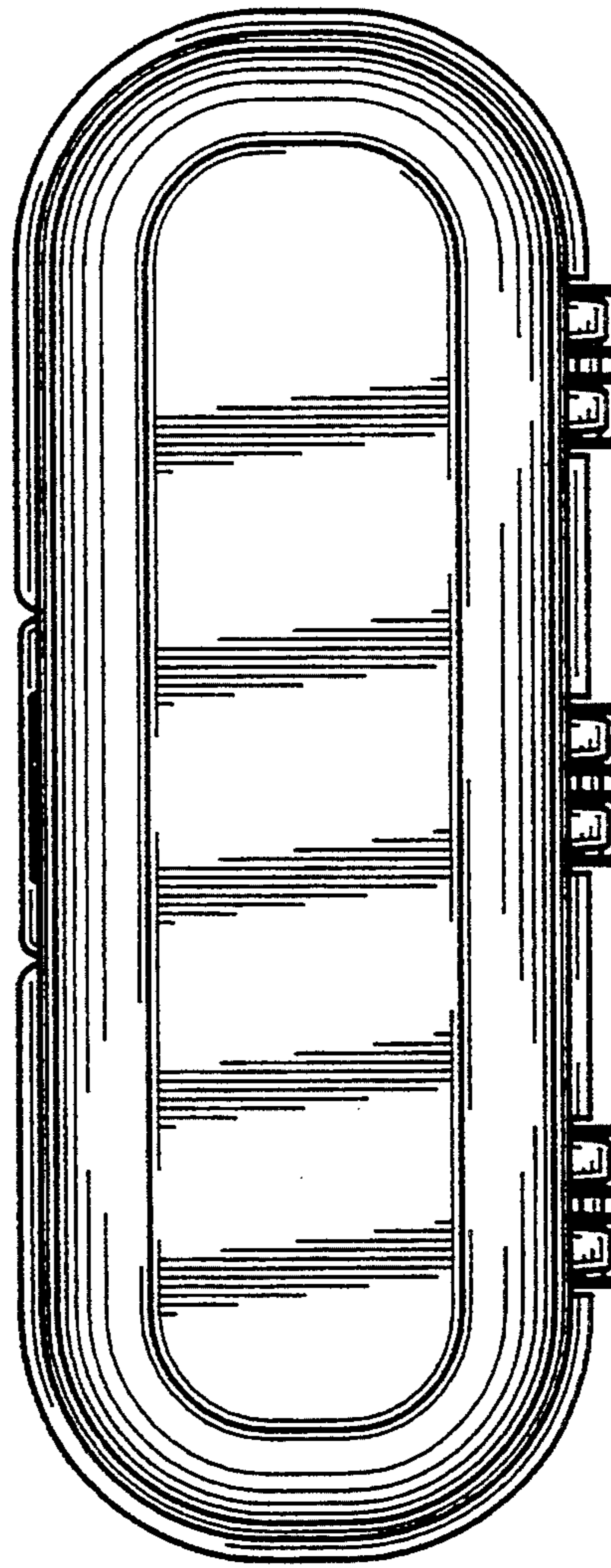

FIG. 6

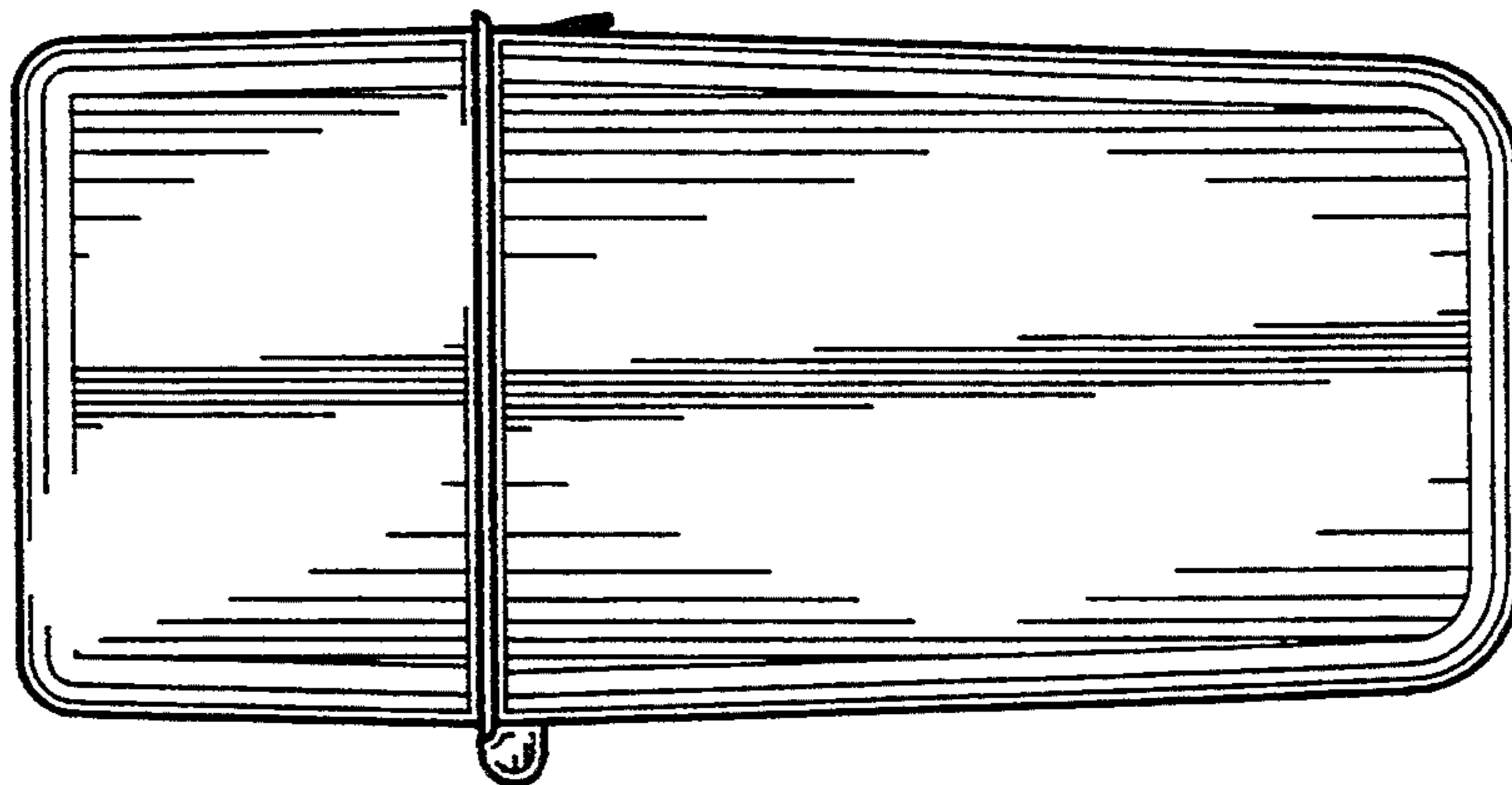

FIG. 4

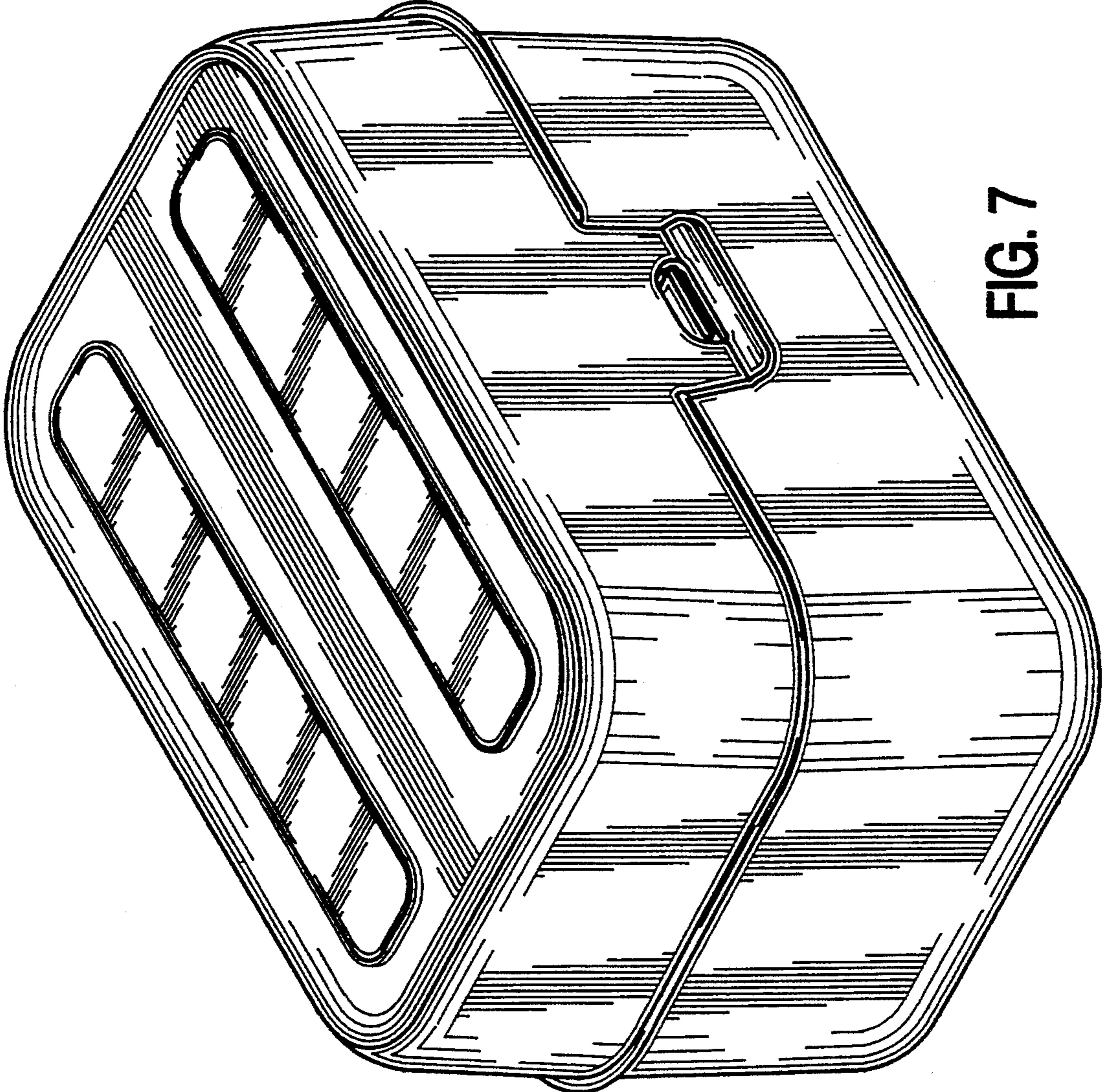

FIG. 7

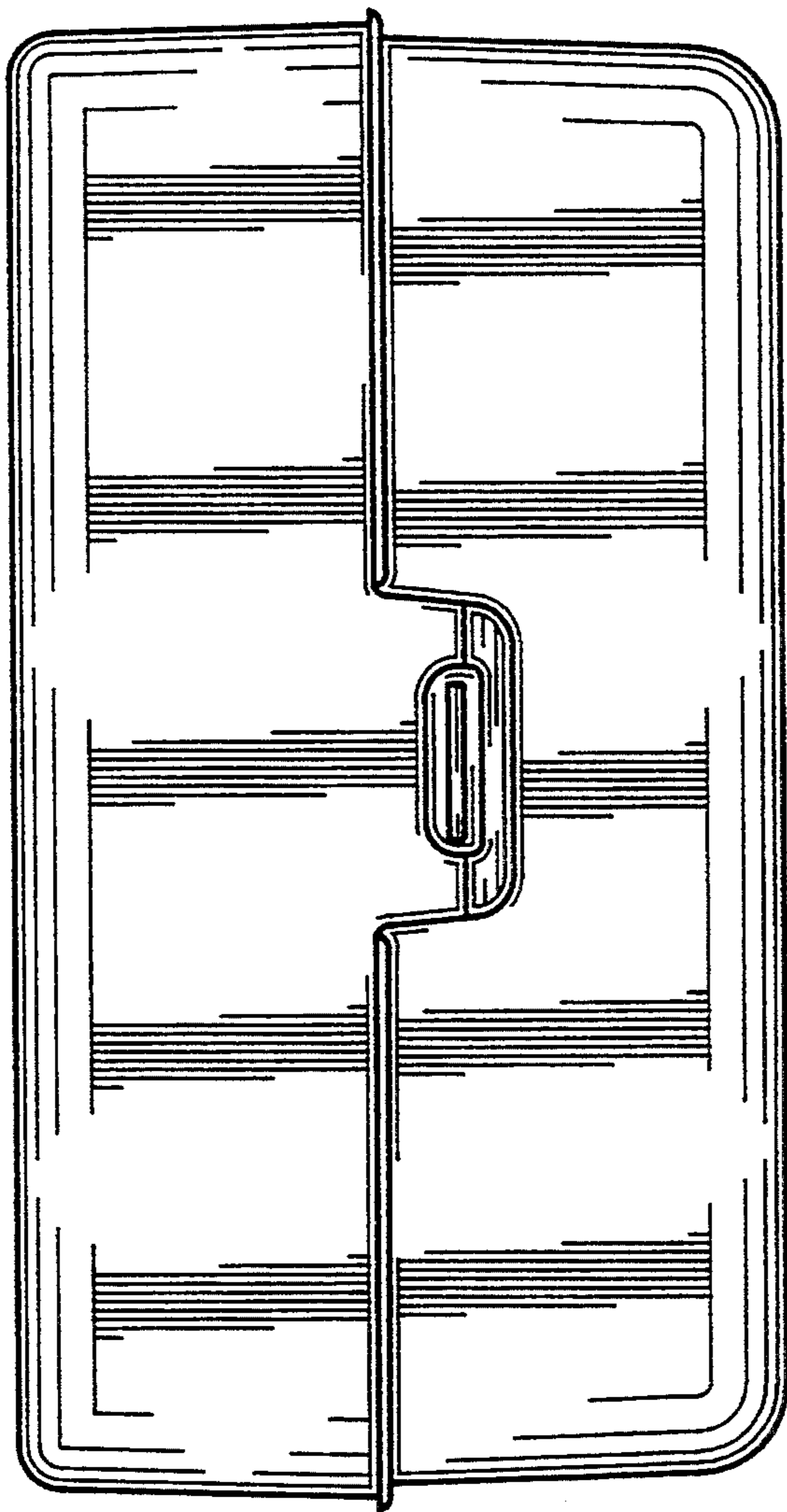

FIG. 8

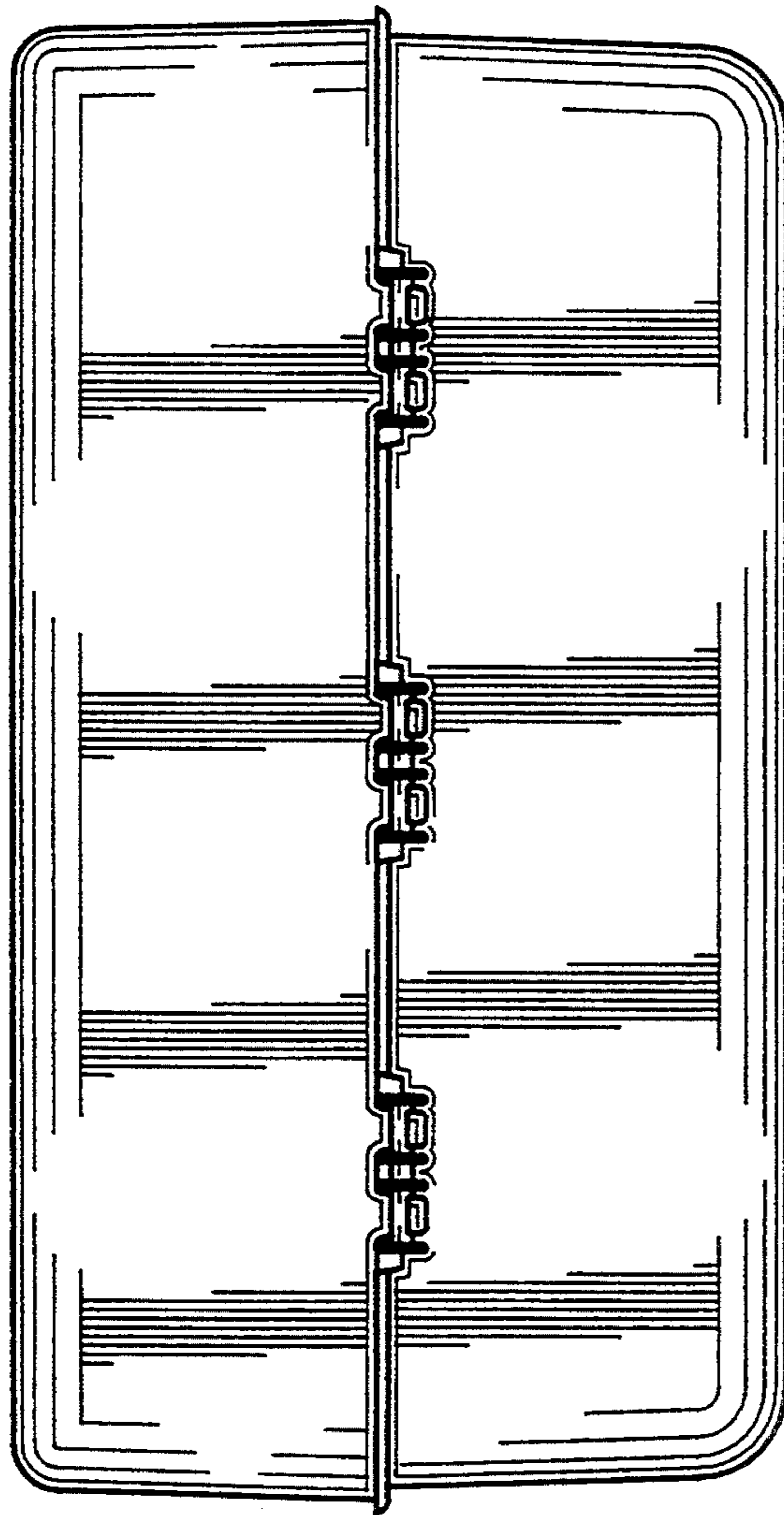

FIG. 9

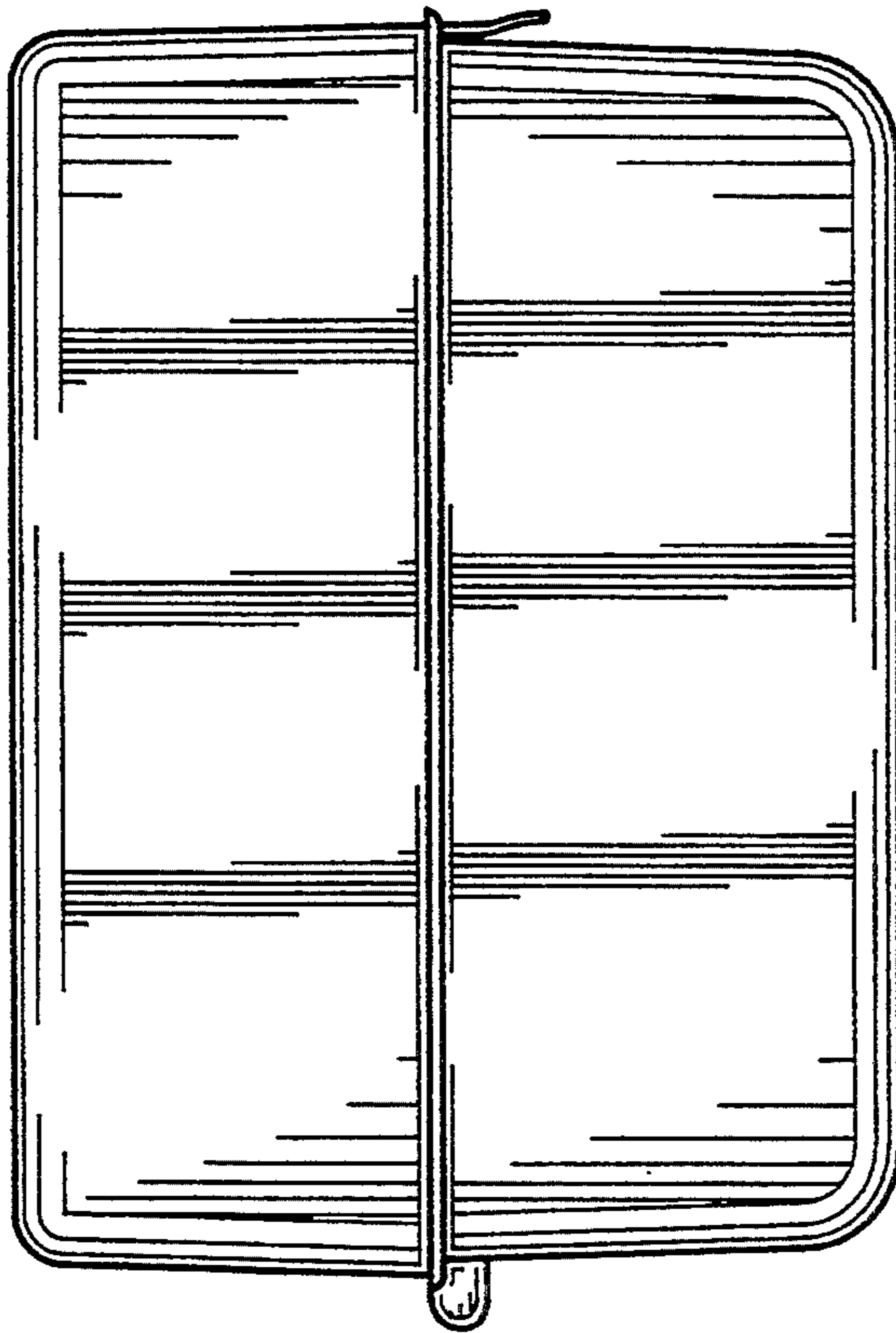

FIG. 10

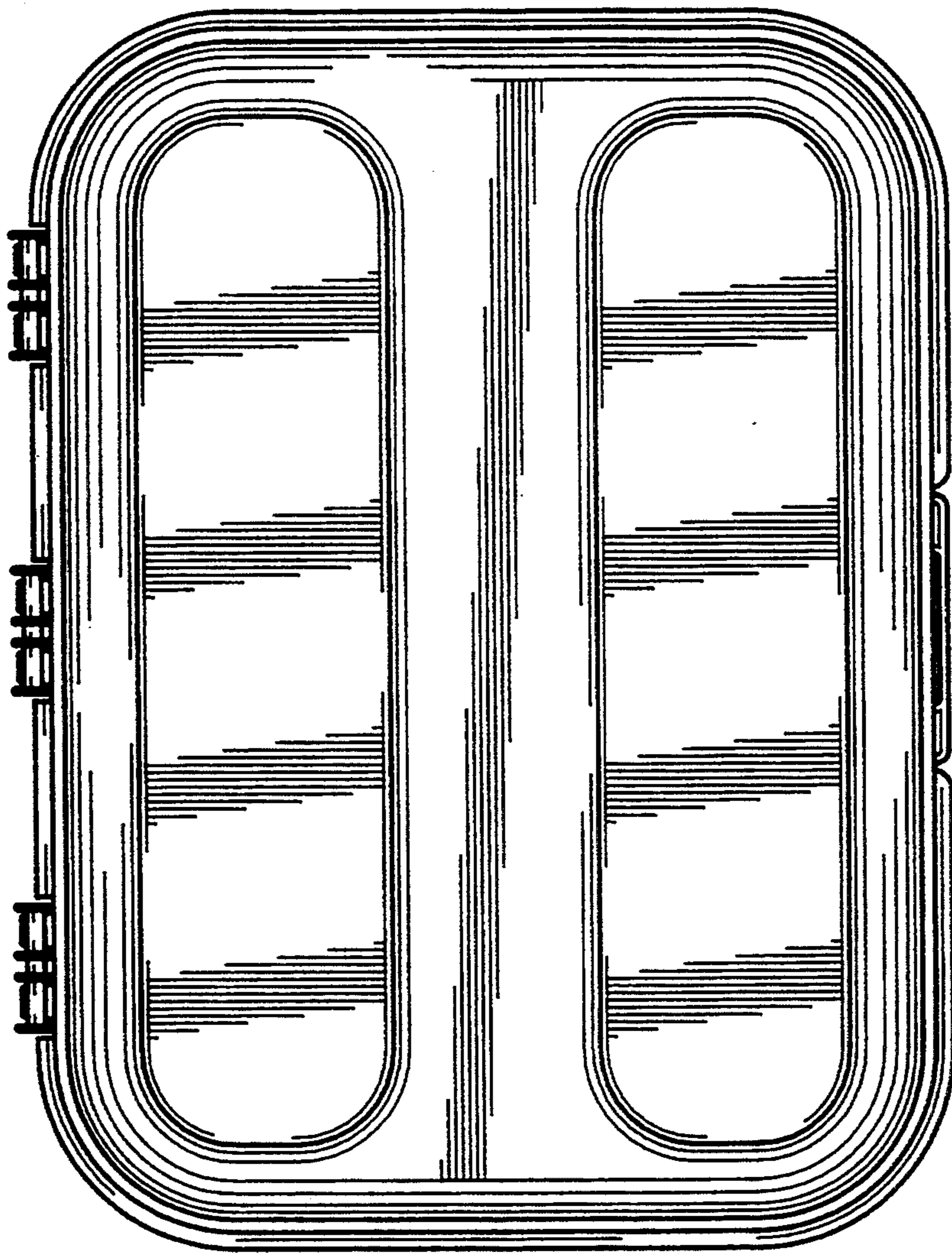

FIG. 11

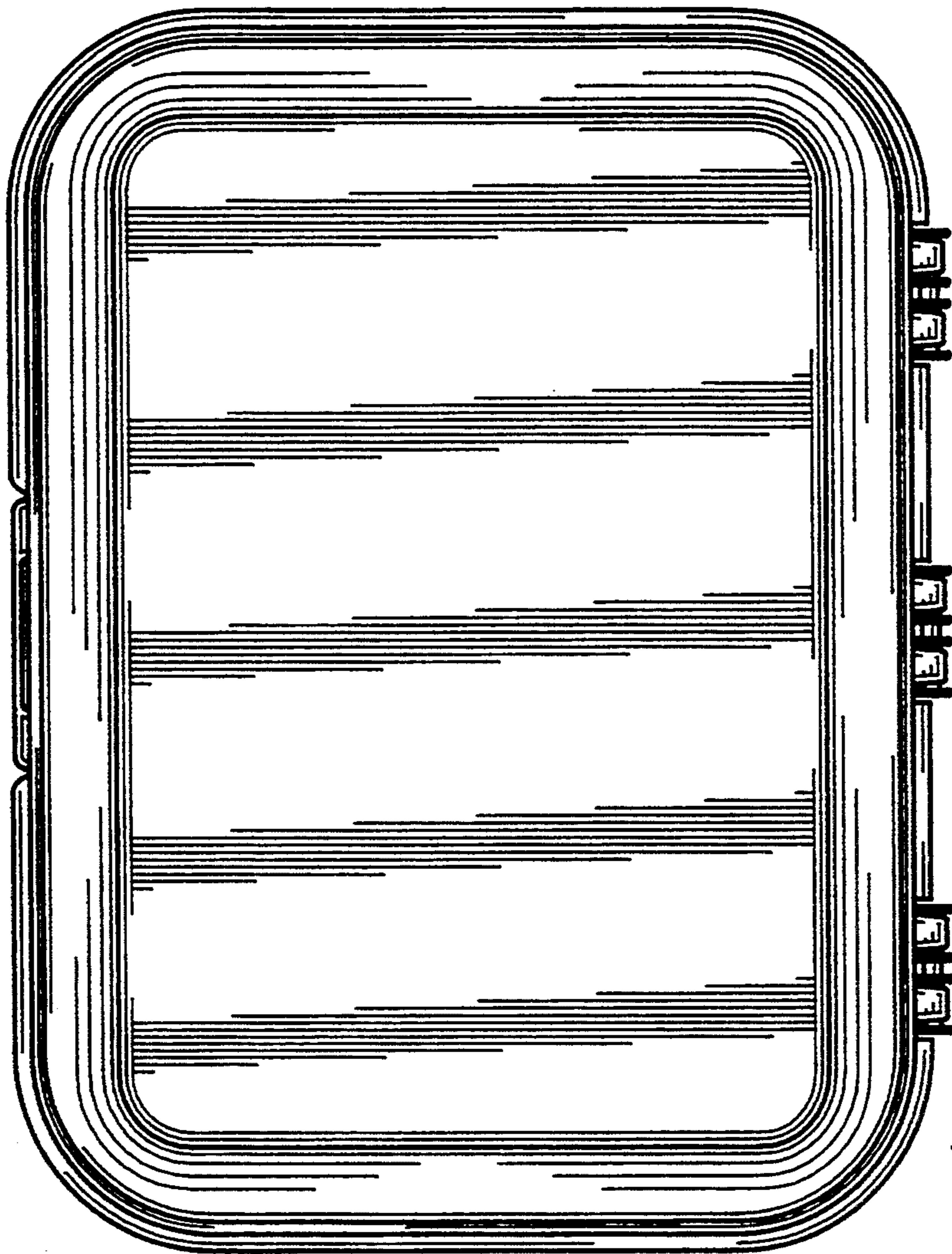

FIG. 12