



US00D357677S

United States Patent [19]

[11] Patent Number: **Des. 357,677**

Sawada et al.

[45] Date of Patent: **** Apr. 25, 1995**

[54] **FACSIMILE MACHINE**

[75] Inventors: **Masazi Sawada, Kyoto; Mikio Ogasawara, Hiroshima; Akira Tsukada, Osaka, all of Japan**

[73] Assignee: **Sharp Kabushiki Kaisha, Osaka, Japan**

[**] Term: **14 Years**

[21] Appl. No.: **5,687**

[22] Filed: **Mar. 9, 1993**

[30] **Foreign Application Priority Data**

Sep. 24, 1992 [JP] Japan 4-28018

[52] U.S. Cl. **D14/118**

[58] Field of Search D14/118, 124, 299; 358/400, 401

[56] **References Cited**

U.S. PATENT DOCUMENTS

D. 300,139 3/1989 Nishio D14/118
D. 310,215 8/1990 Tsukada et al. D14/118

D. 312,252 11/1990 Nishio et al. D14/118
D. 323,494 1/1992 Kashiwabara et al. D14/118
D. 331,756 12/1992 Sawada et al. D14/118
D. 331,924 12/1992 Sawada et al. D14/118
D. 331,925 12/1992 Sawada et al. D14/118
D. 332,094 12/1992 Sawada et al. D14/118

Primary Examiner—Theodore M. Shooman
Attorney, Agent, or Firm—Nixon & Vanderhye

[57] **CLAIM**

The ornamental design for a facsimile machine, as shown and described.

DESCRIPTION

FIG. 1 is a top, front and right side perspective view of a facsimile machine according to our design;
FIG. 2 is a top plan view thereof;
FIG. 3 is a front elevational view thereof;
FIG. 4 is a right side elevational view thereof;
FIG. 5 is a rear elevational view thereof;
FIG. 6 is a left side elevational view thereof;
FIG. 7 is a bottom plan view thereof; and,
FIG. 8 is a right side elevational view thereof with a stand extended for supporting the facsimile machine.

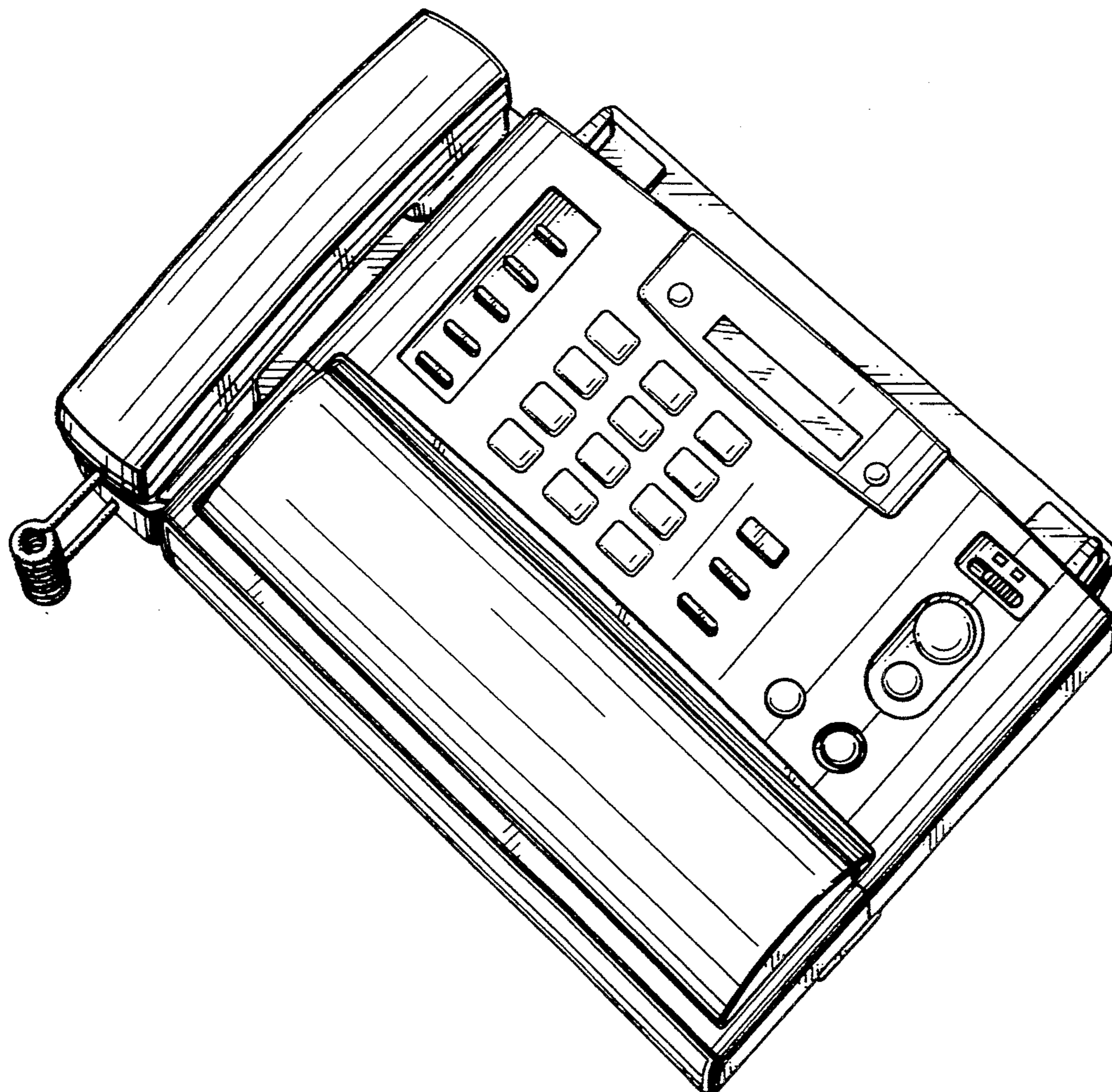

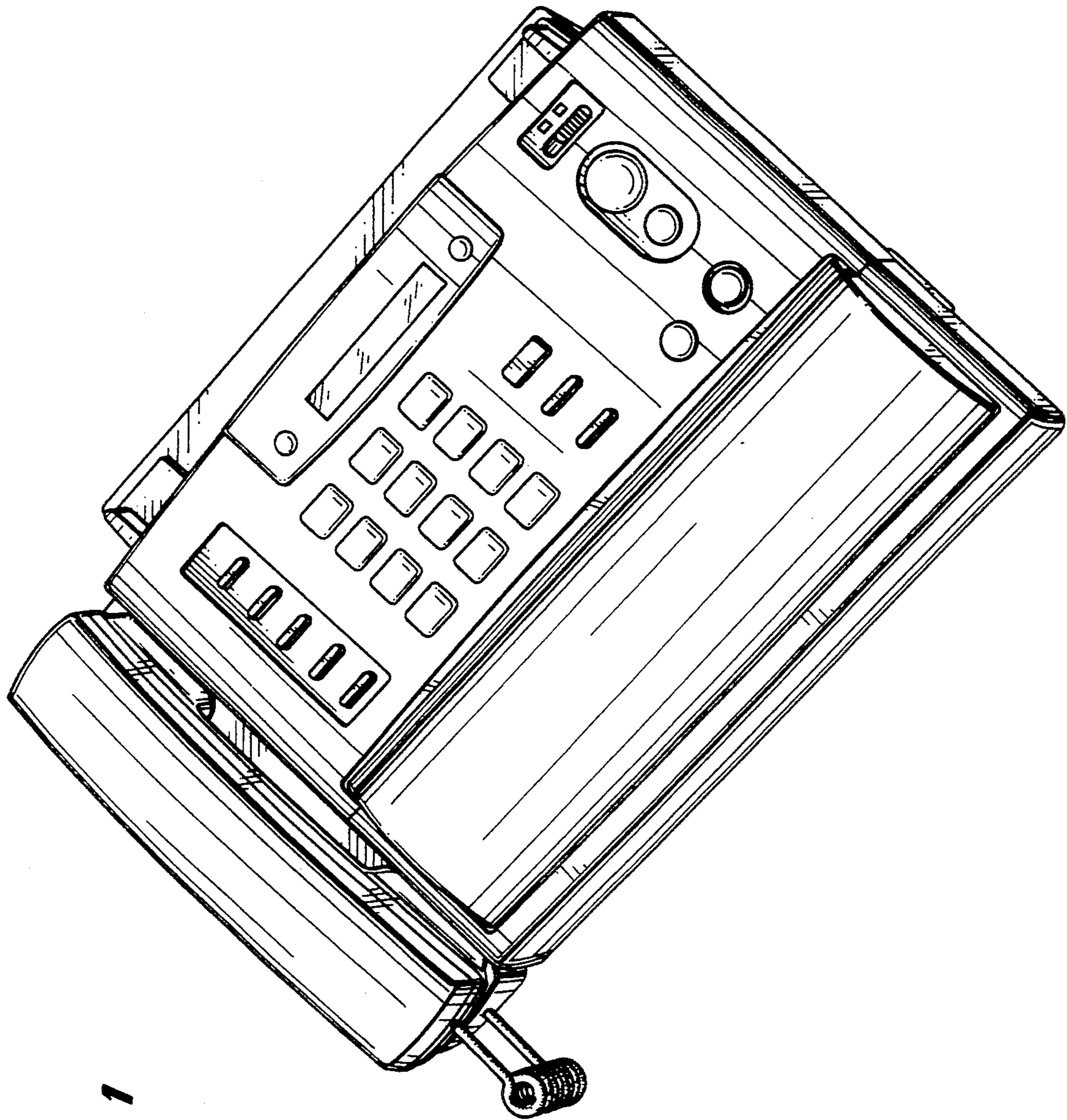
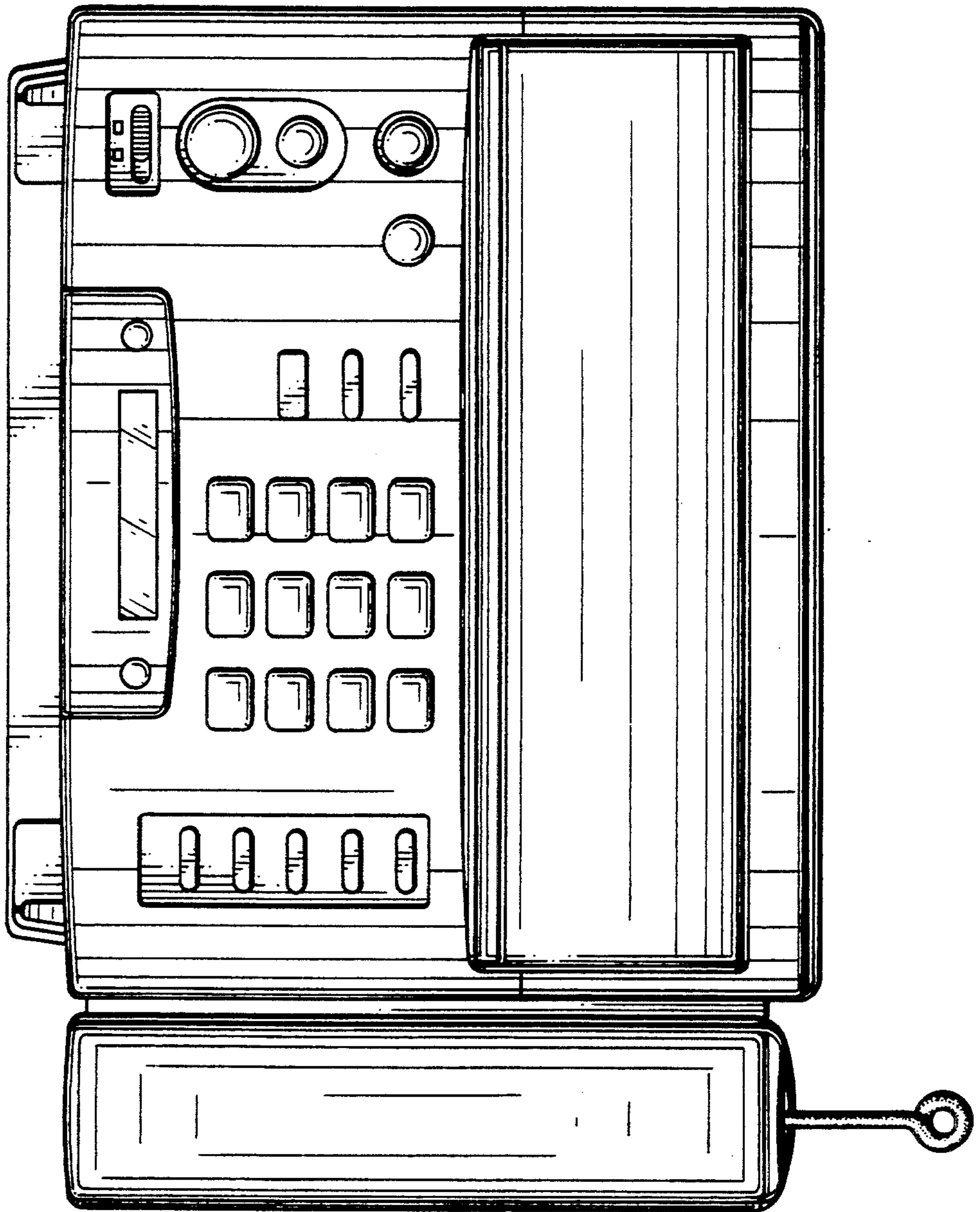

FIG. 1

FIG. 2



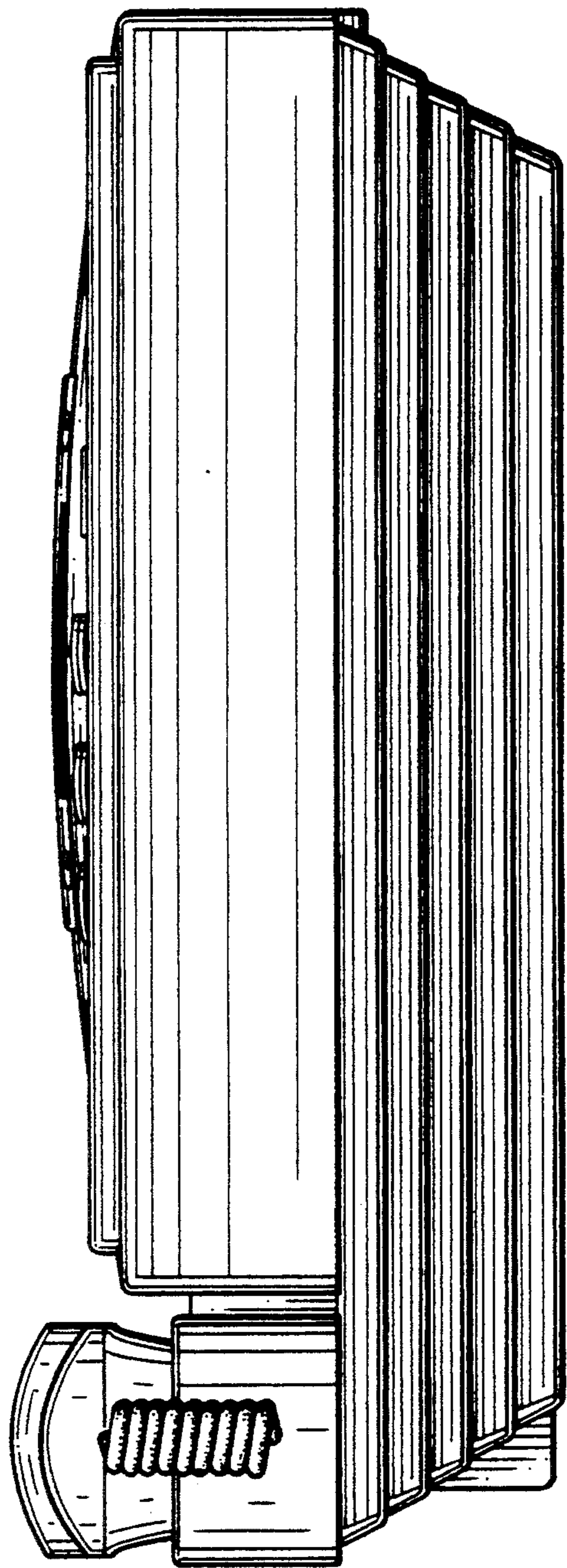

FIG. 3

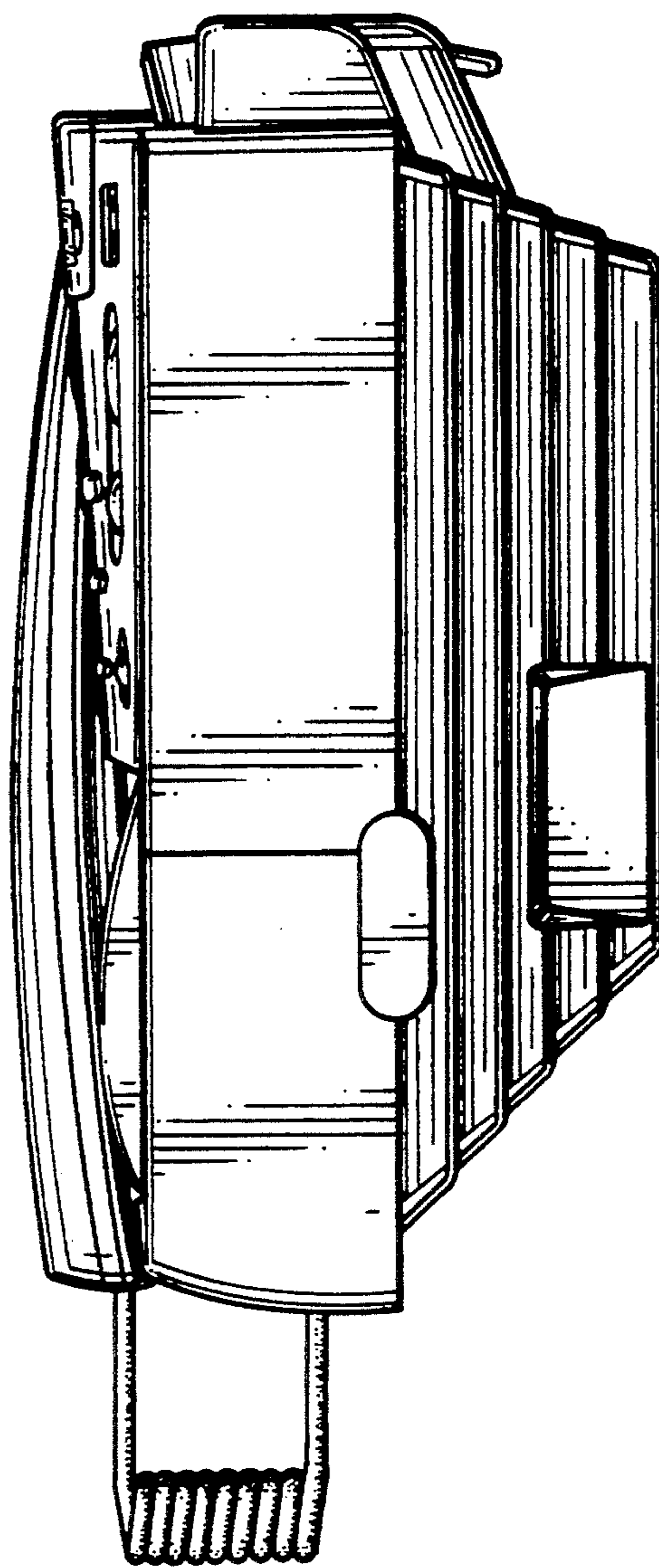

FIG. 4

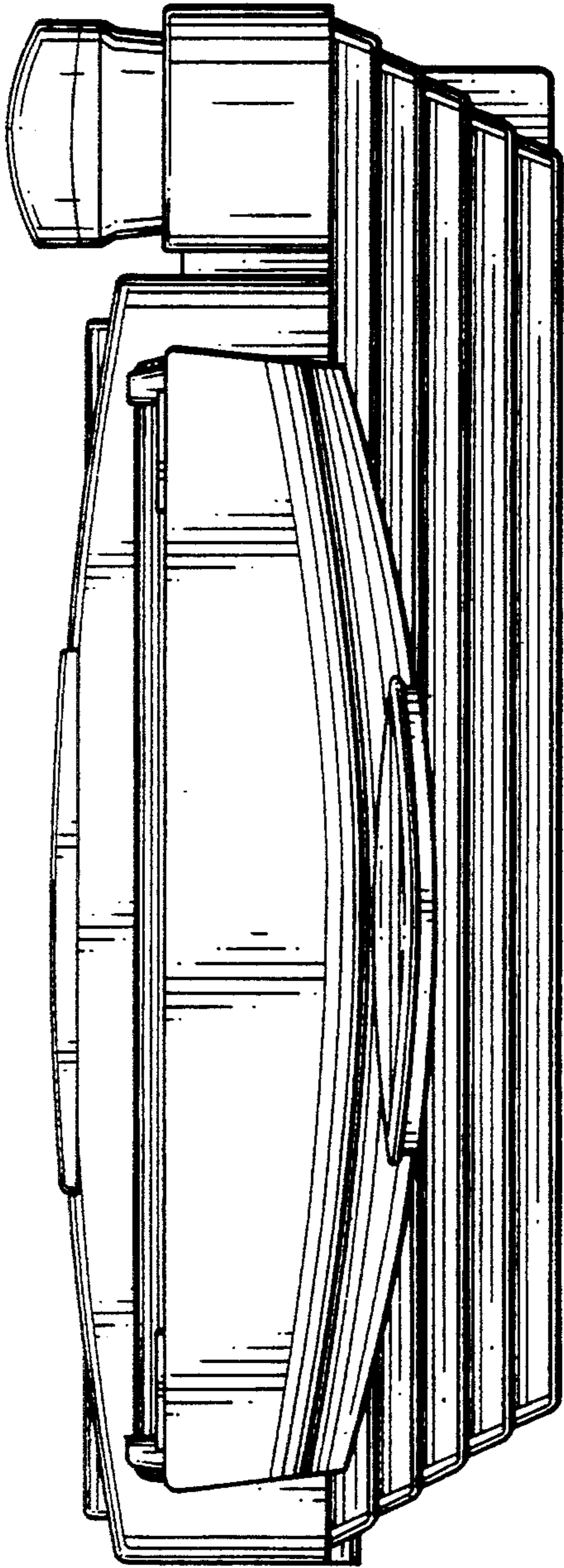

FIG. 5

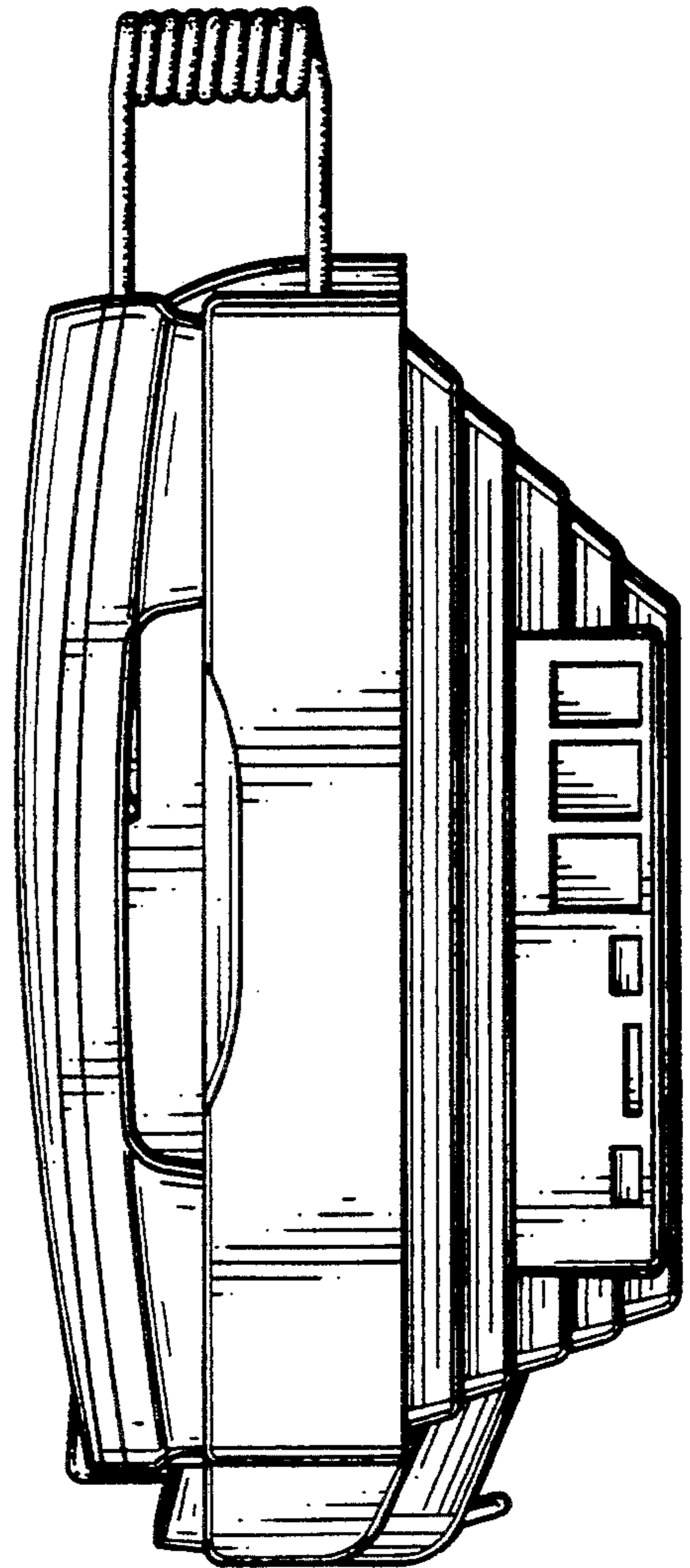
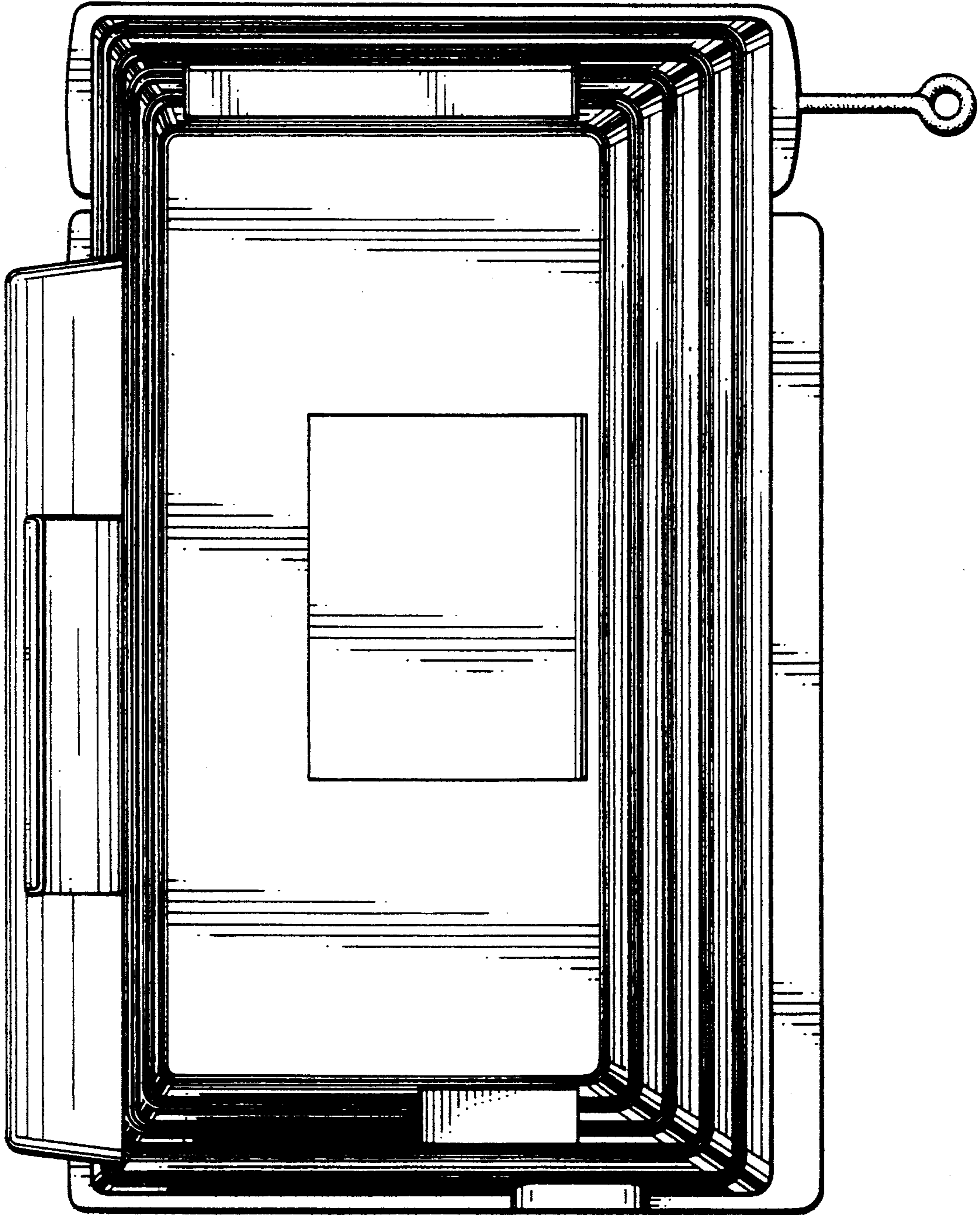

FIG. 6

FIG. 7



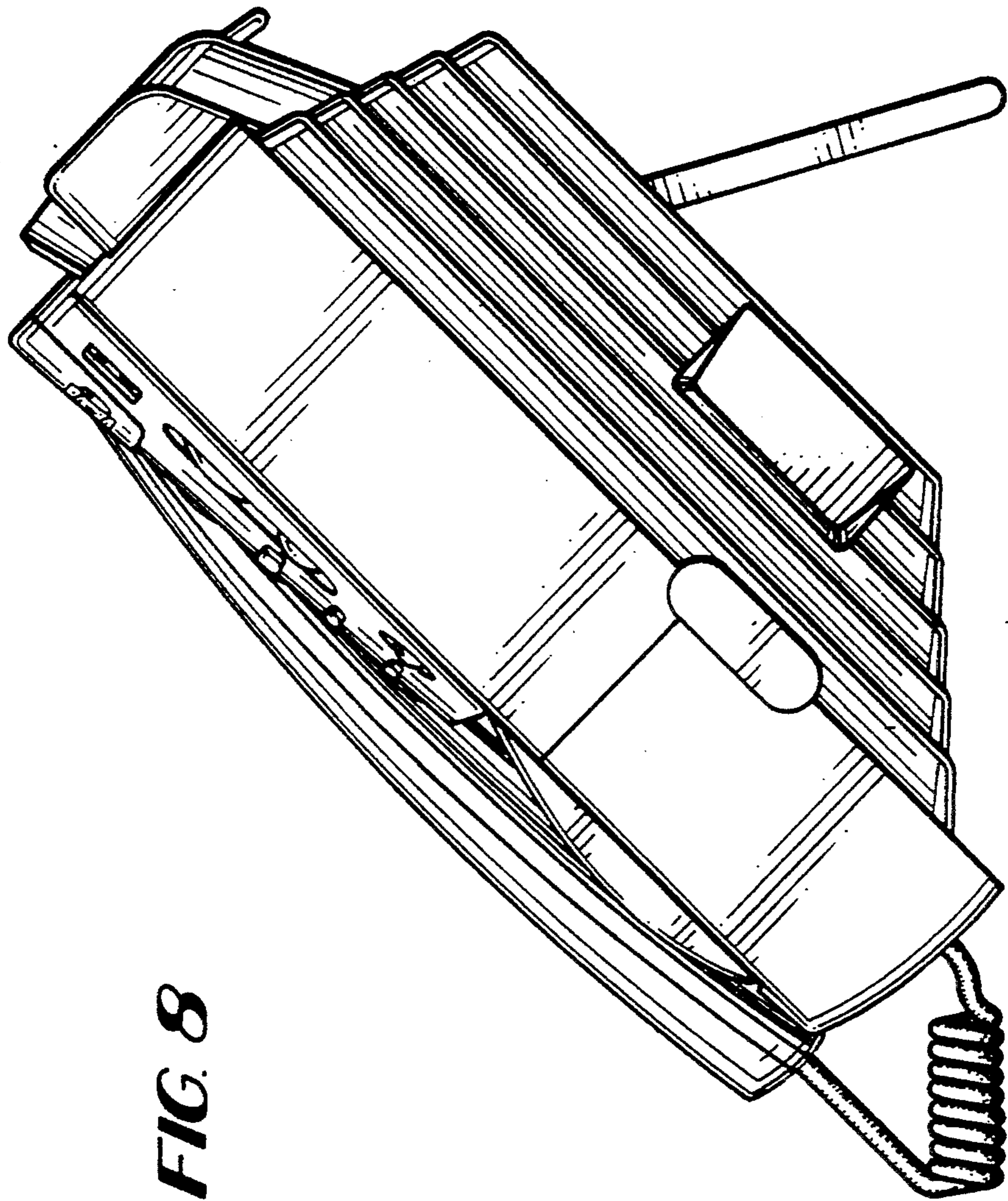

FIG. 8