



US00D357542S

United States Patent [19]

[11] Patent Number: **Des. 357,542**

Vaichis

[45] Date of Patent: **** Apr. 18, 1995**

[54] **BABY BOTTLE**

Primary Examiner—Stella Reid
Attorney, Agent, or Firm—Richard L. Myers

[76] Inventor: **Philip J. Vaichis**, 688 Camino de los Mares #3, San Clemente, Calif. 92673

[57] **CLAIM**

The ornamental design for a baby bottle, as shown.

[**] Term: **14 Years**

DESCRIPTION

[21] Appl. No.: **13,005**

FIG. 1 is a perspective view of a baby bottle showing my new design, the broken line showing is for illustrative purposes only and forms no part of the claimed design;

[22] Filed: **Sep. 15, 1993**

[52] U.S. Cl. **D24/197**

FIG. 2 is a top plan view thereof;

[58] Field of Search D24/197; 215/11.1, 11.2, 215/11.3, 11.4, 11.5, 11.6; D9/516, 524, 528, 530, 543

FIG. 3 is a front elevational view thereof;

FIG. 4 is a side elevational view thereof;

[56] **References Cited**

U.S. PATENT DOCUMENTS

- 4,700,856 10/1987 Campbell et al. 215/11.3
- 4,813,556 3/1989 Lawrence 215/11.3

FIG. 5 is a bottom plan view thereof;

FIG. 6 is a rear elevational view thereof; and,

FIG. 7 is a side elevational view thereof, opposite that shown in FIG. 4.

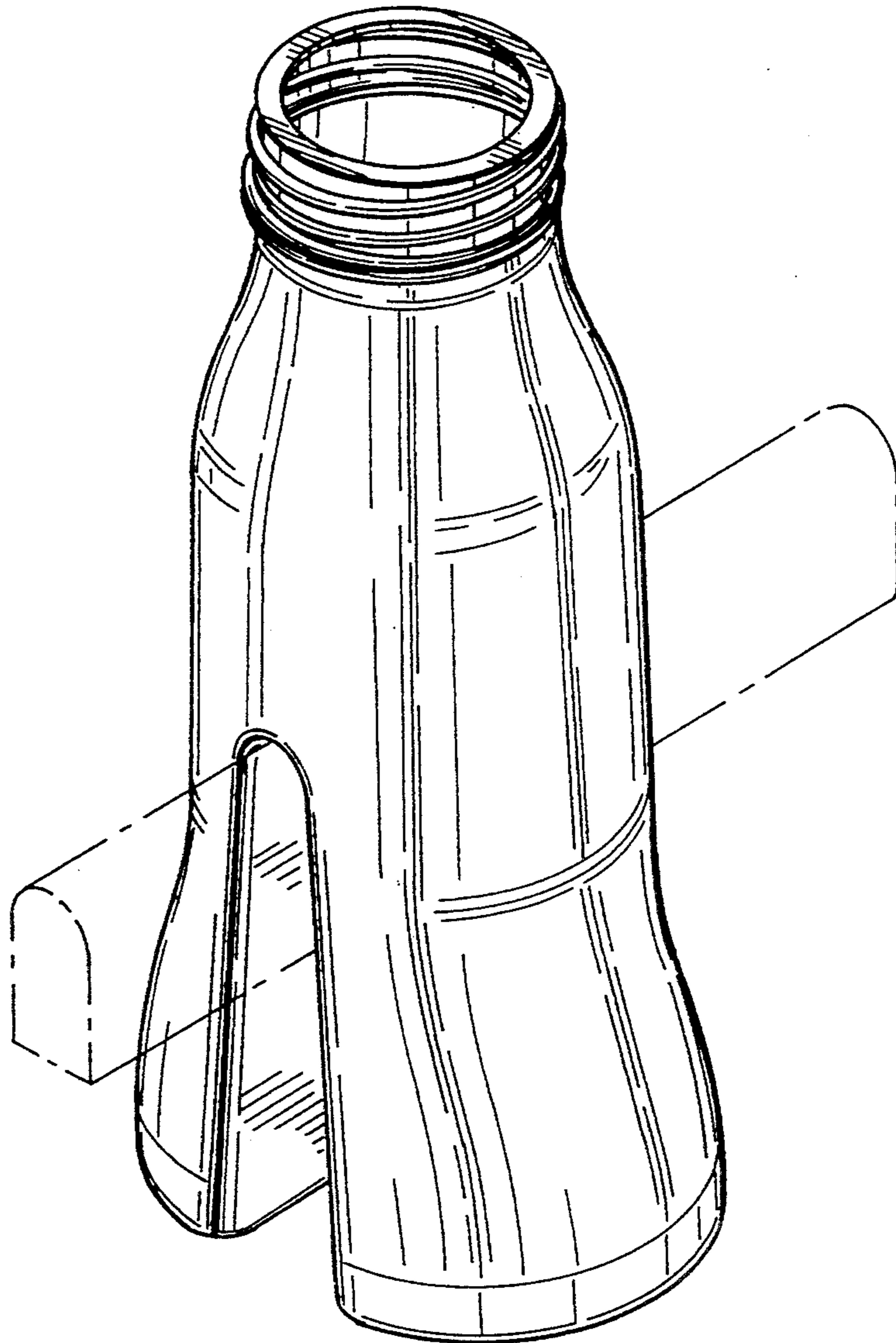

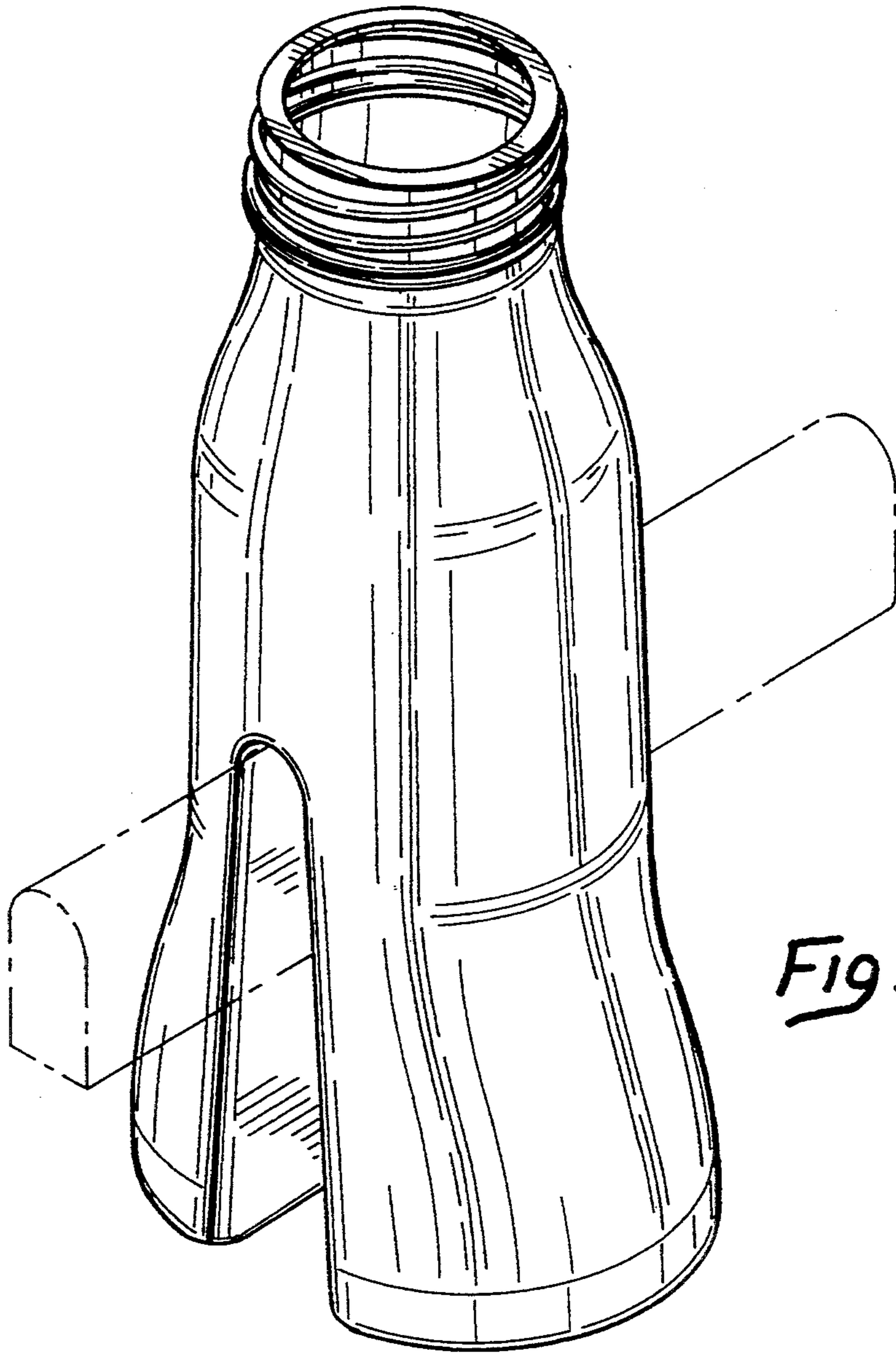

Fig. 1

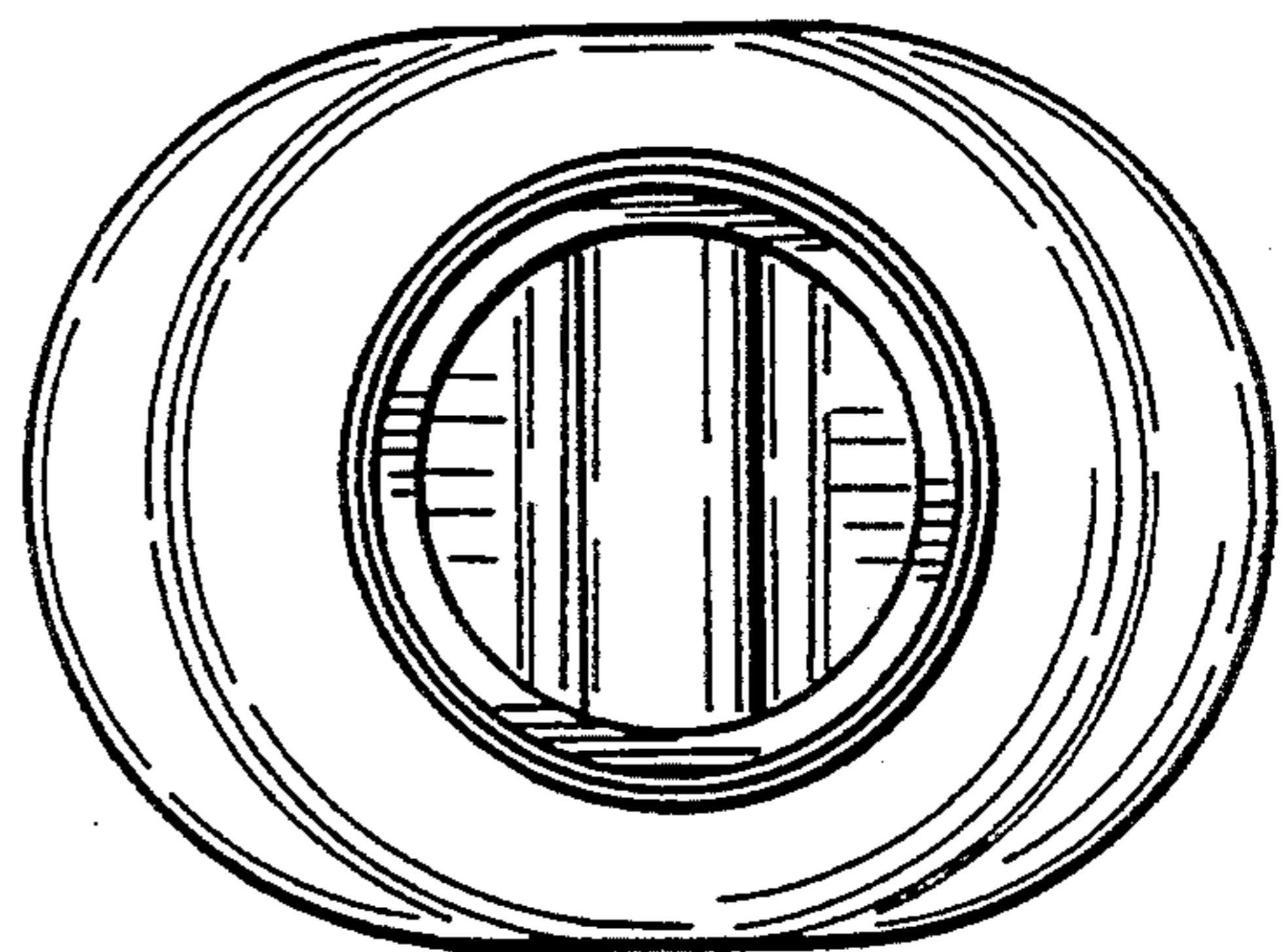

Fig. 2

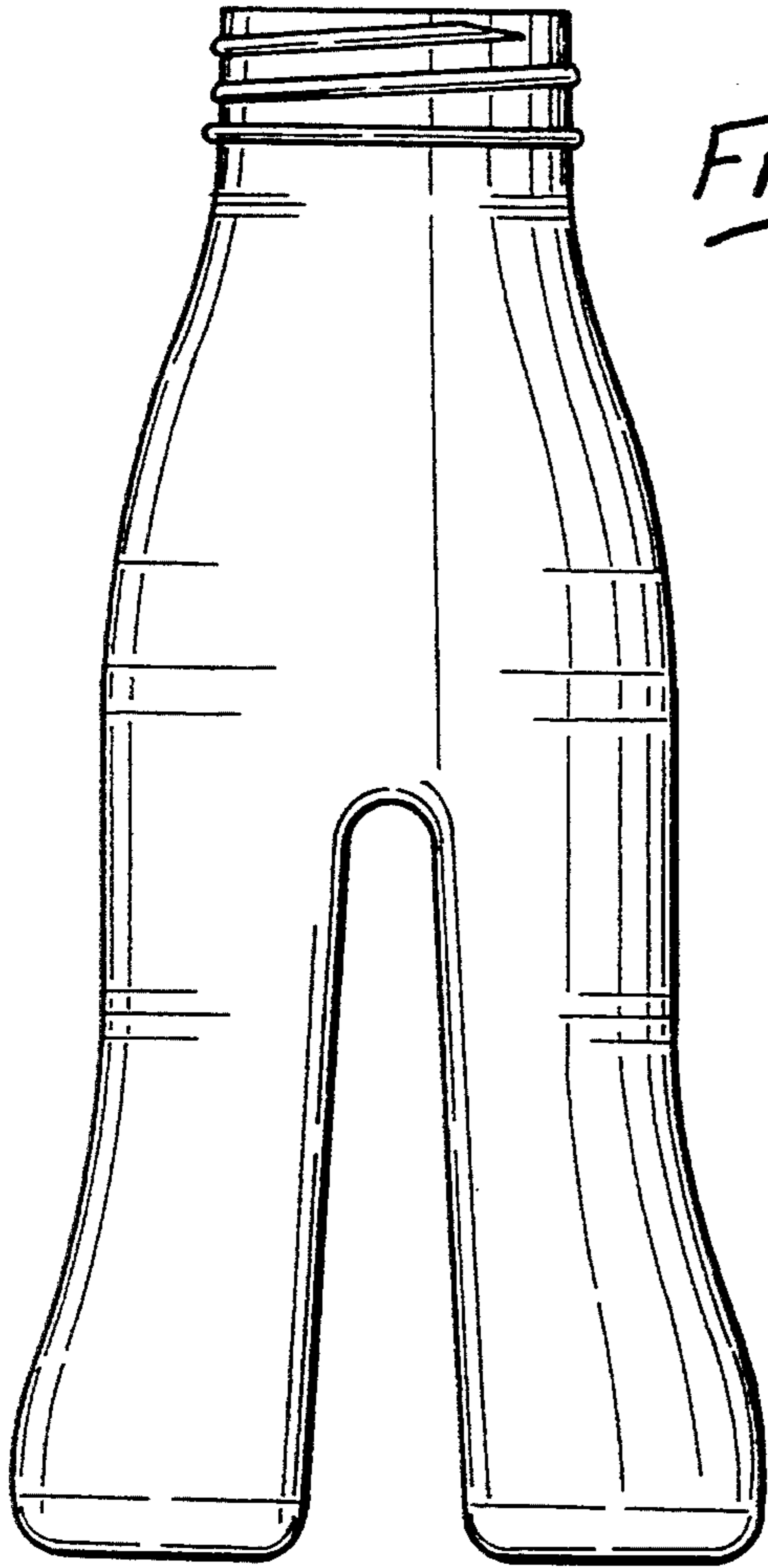

Fig. 3

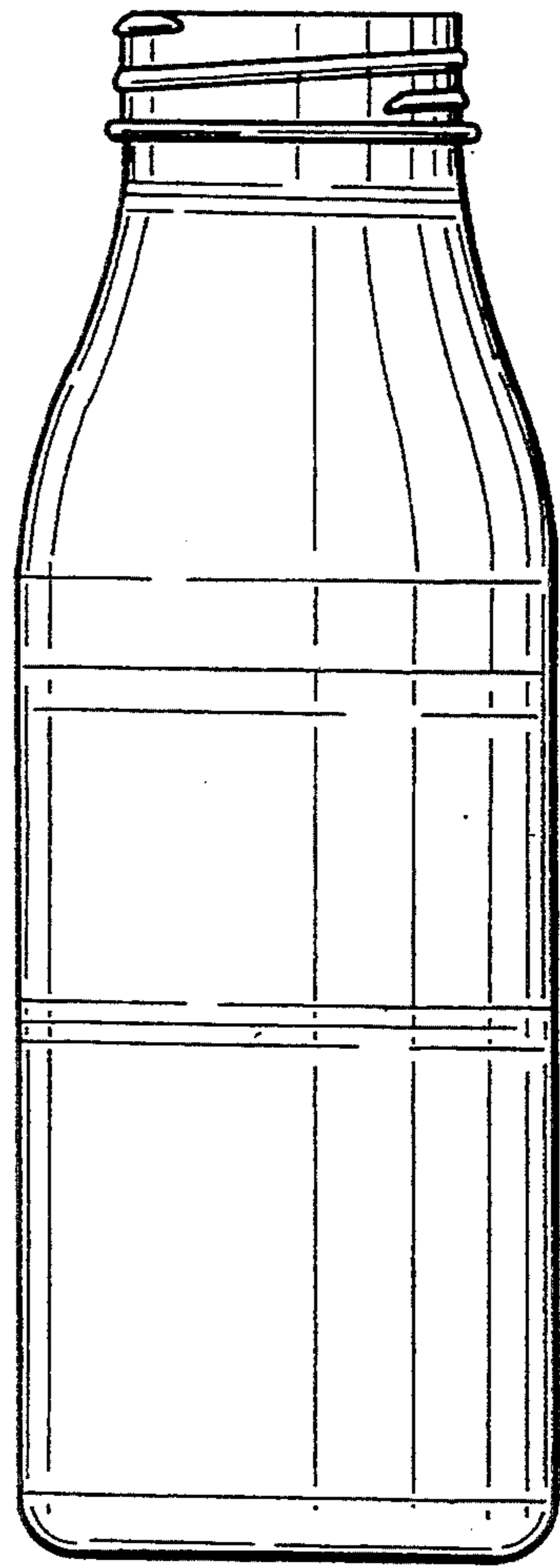

Fig. 4

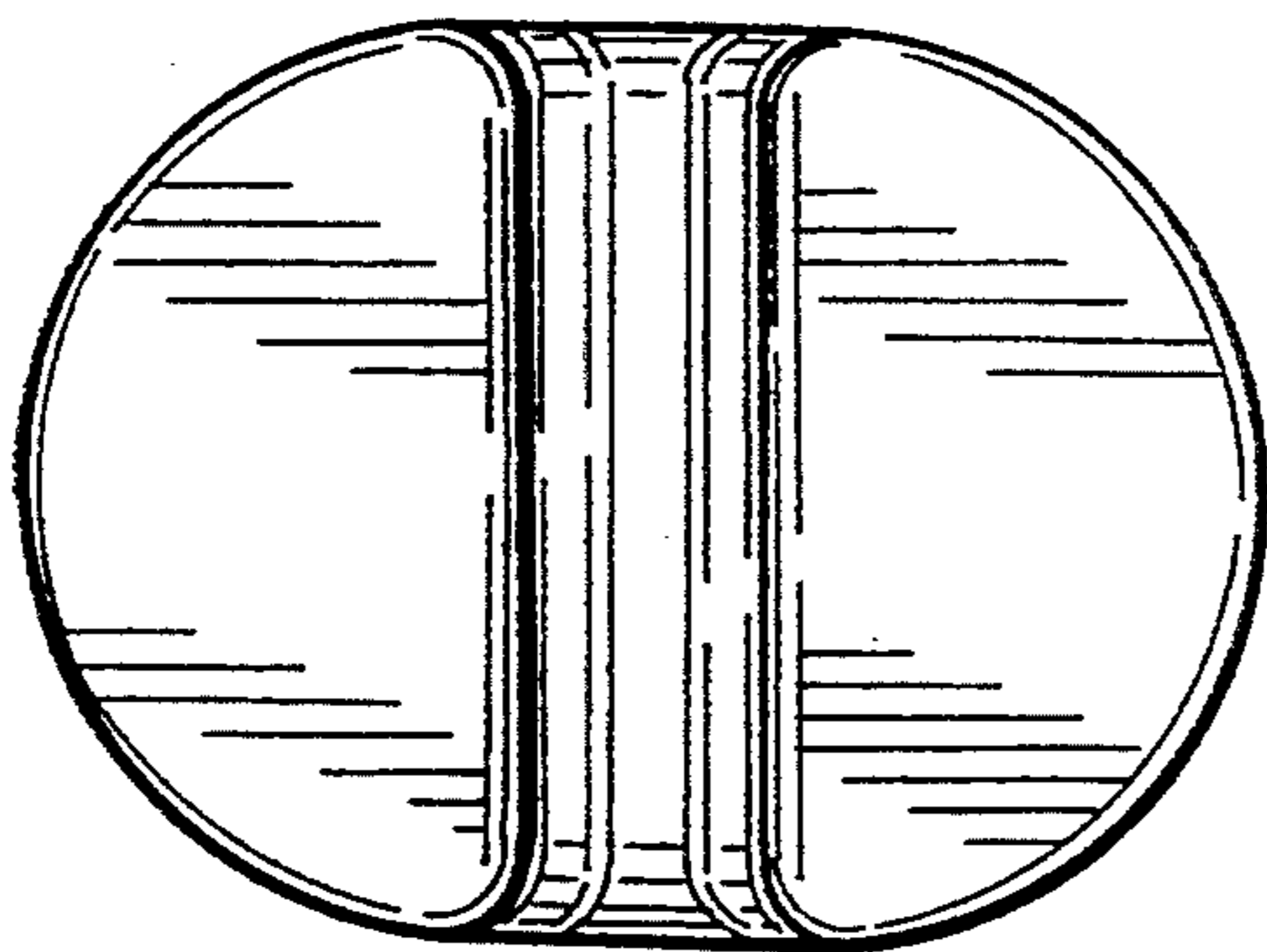

Fig. 5

Fig. 6

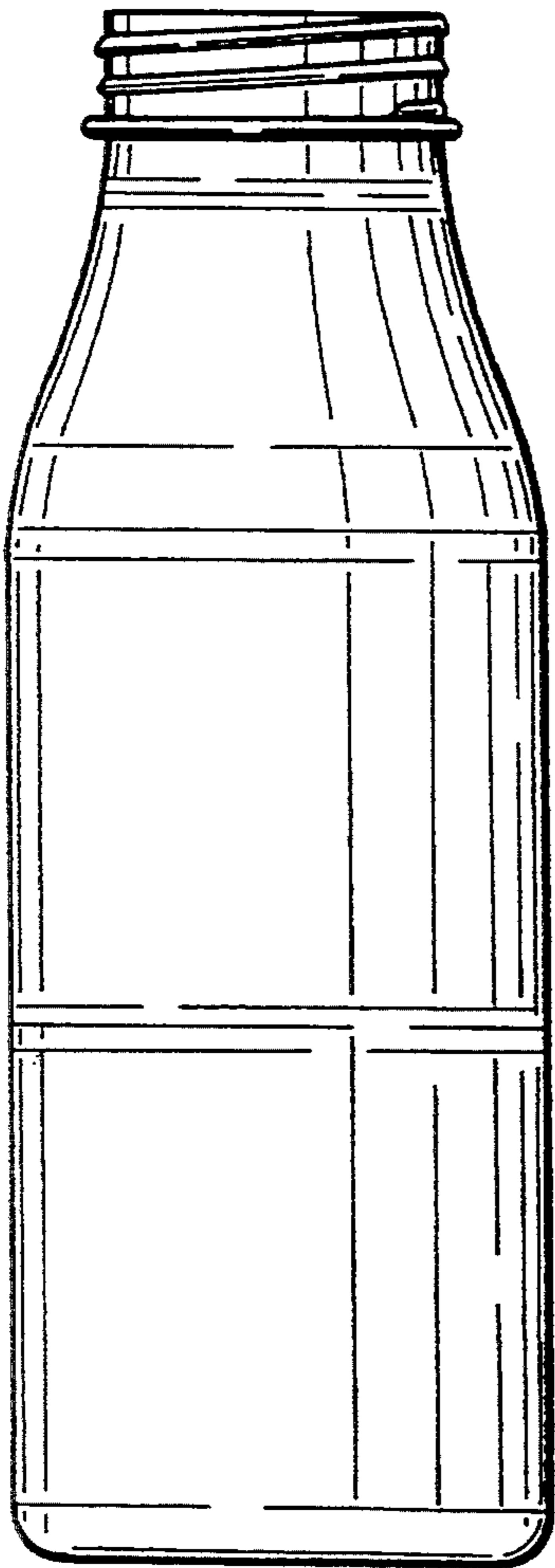
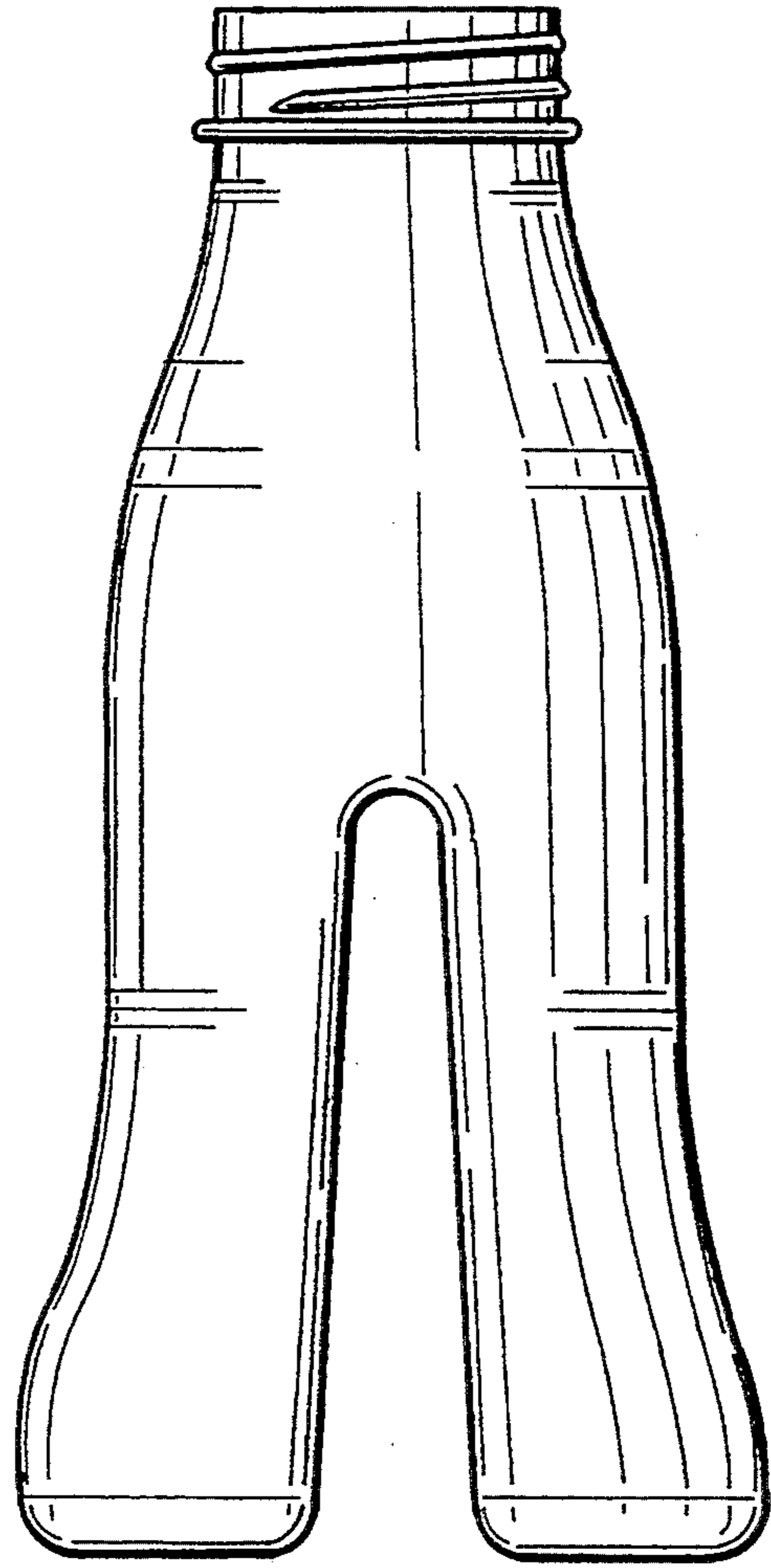

Fig. 7