



US00D357471S

# United States Patent [19]

[11] Patent Number: **Des. 357,471**

Reph

[45] Date of Patent: **\*\* Apr. 18, 1995**

[54] **STAND FOR A COMBINED CREDIT CARD PRINTER AND TERMINAL**

[76] Inventor: **Glenn A. Reph**, 3835 Catamarca Dr., San Diego, Calif. 92124

[\*\*] Term: **14 Years**

[21] Appl. No.: **18,451**

[22] Filed: **Feb. 7, 1994**

### Related U.S. Application Data

[63] Continuation of Ser. No. 740,763, Aug. 6, 1991, abandoned.

[52] U.S. Cl. .... **D14/114; D18/4; D18/12**

[58] Field of Search ..... **D14/100, 105; D18/4, D18/11, 12, 14; 235/379, 380, 382, 382.5, 483, 492, 493; 354/80-82; 248/121, 127, 146**

[56] **References Cited**

### U.S. PATENT DOCUMENTS

D. 227,771	7/1973	Mulholland	.....	D14/106
D. 245,200	7/1977	Packard	.....	D18/11
D. 297,237	8/1988	Long	.....	D14/105
D. 305,643	1/1990	Stark et al.	.....	D14/105
D. 309,297	7/1990	Suda	.....	D14/105
D. 310,826	9/1990	Suda	.....	D14/105
D. 319,633	9/1991	Nogawa	.....	D14/105

### OTHER PUBLICATIONS

1988 VeriFone, Inc. TRANZFone™ Installation Guide, 11 pages.

Two sheets of 4 photos of VeriFone, Inc. prior art.

*Primary Examiner*—Freda S. Nunn

*Attorney, Agent, or Firm*—Zarley, McKee, Thomte, Voorhees, & Sease

[57] **CLAIM**

The ornamental design for a stand for a combined credit card printer and terminal, as shown and described.

### DESCRIPTION

FIG. 1 is a reduced front perspective view of a stand for a combined credit card printer and terminal showing my new design;

FIG. 2 is a top plan view thereof;

FIG. 3 is a front elevational view thereof;

FIG. 4 is a rear elevational view thereof;

FIG. 5 is an end elevational view taken from the right side as viewed in FIG. 1;

FIG. 6 is an end elevational view thereof taken from the left side as viewed in FIG. 1; and,

FIG. 7 is a reduced front perspective view thereof showing the printer and terminal in broken lines for illustration purposes only and forming no part of the claimed design.

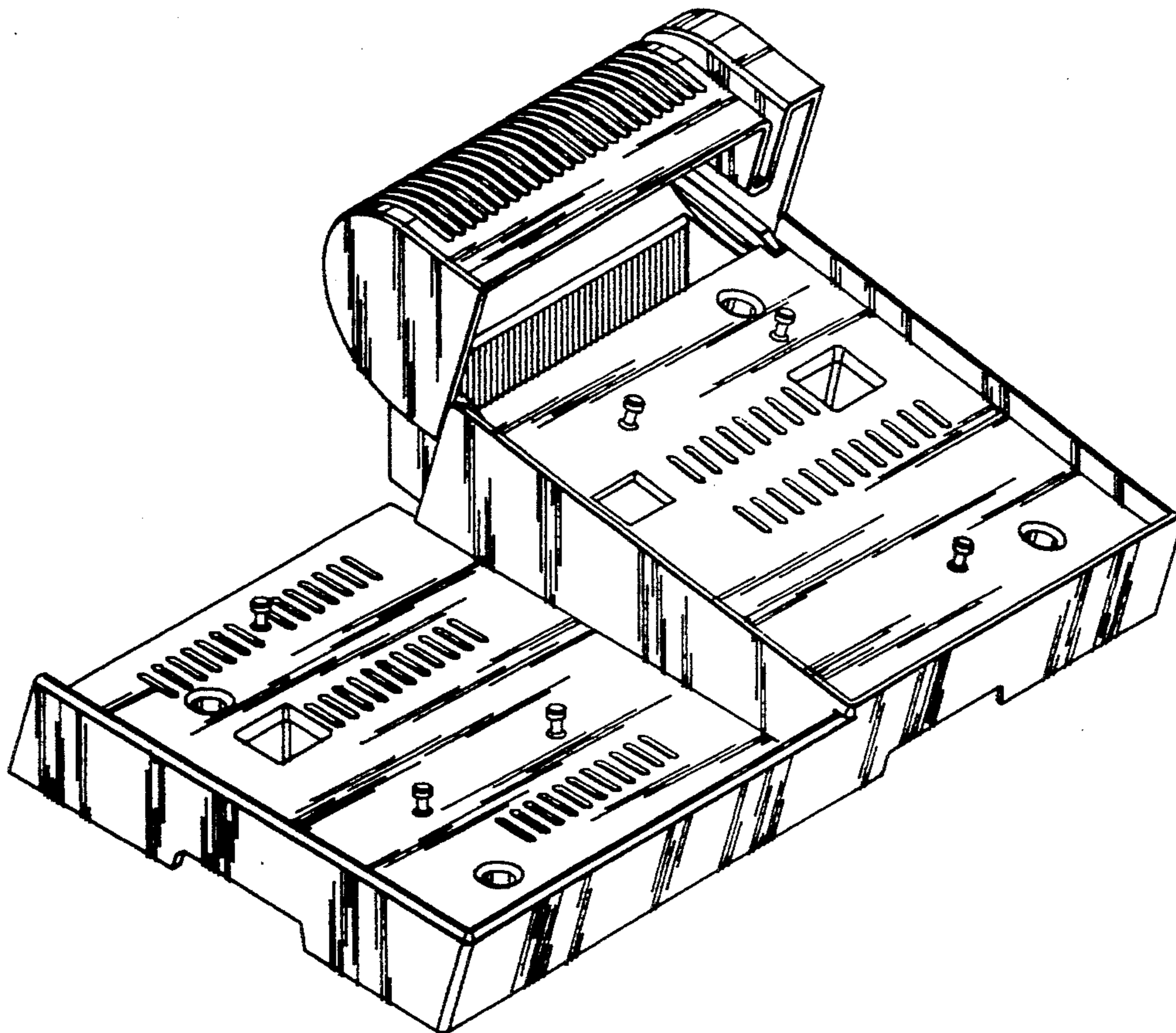

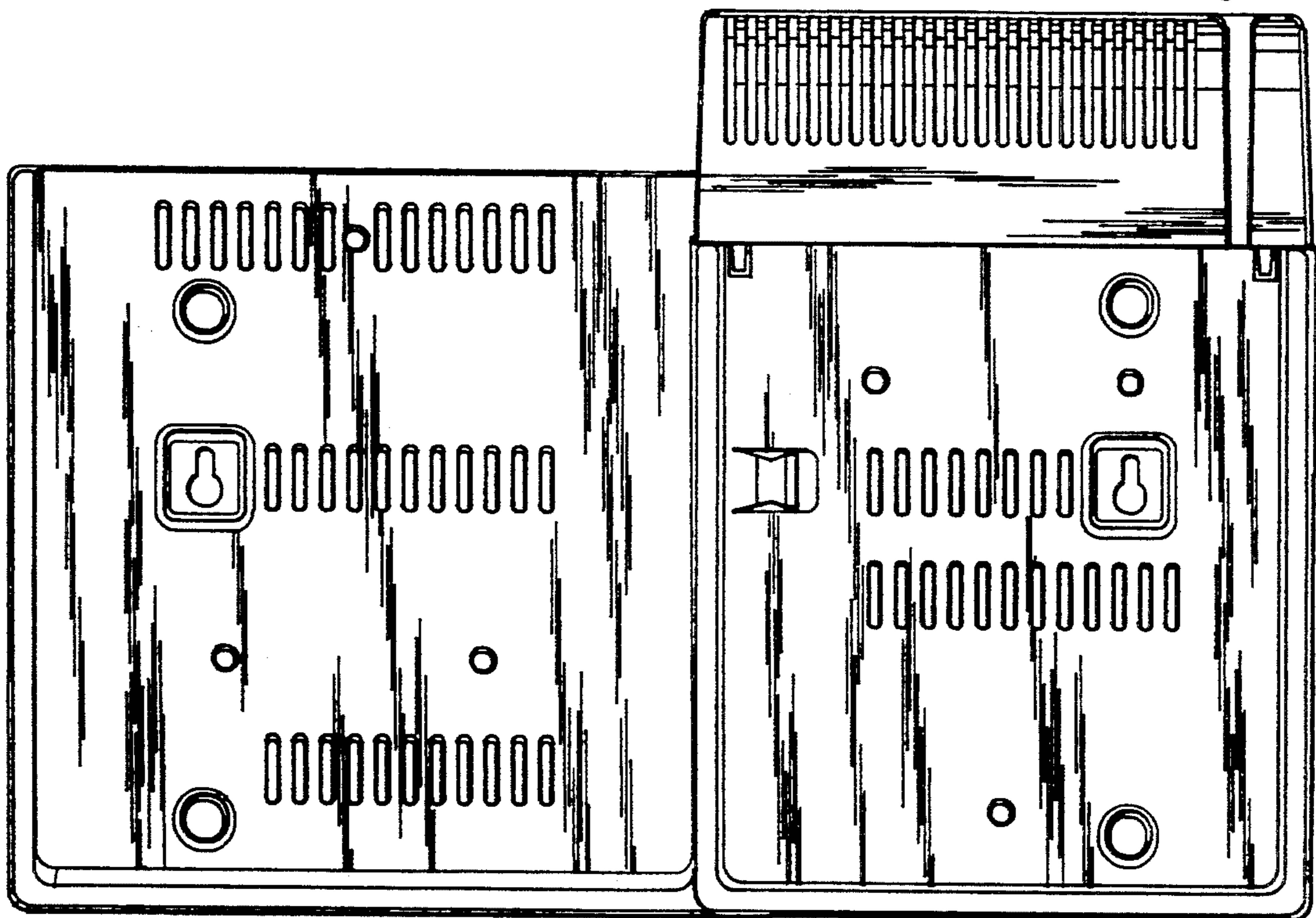
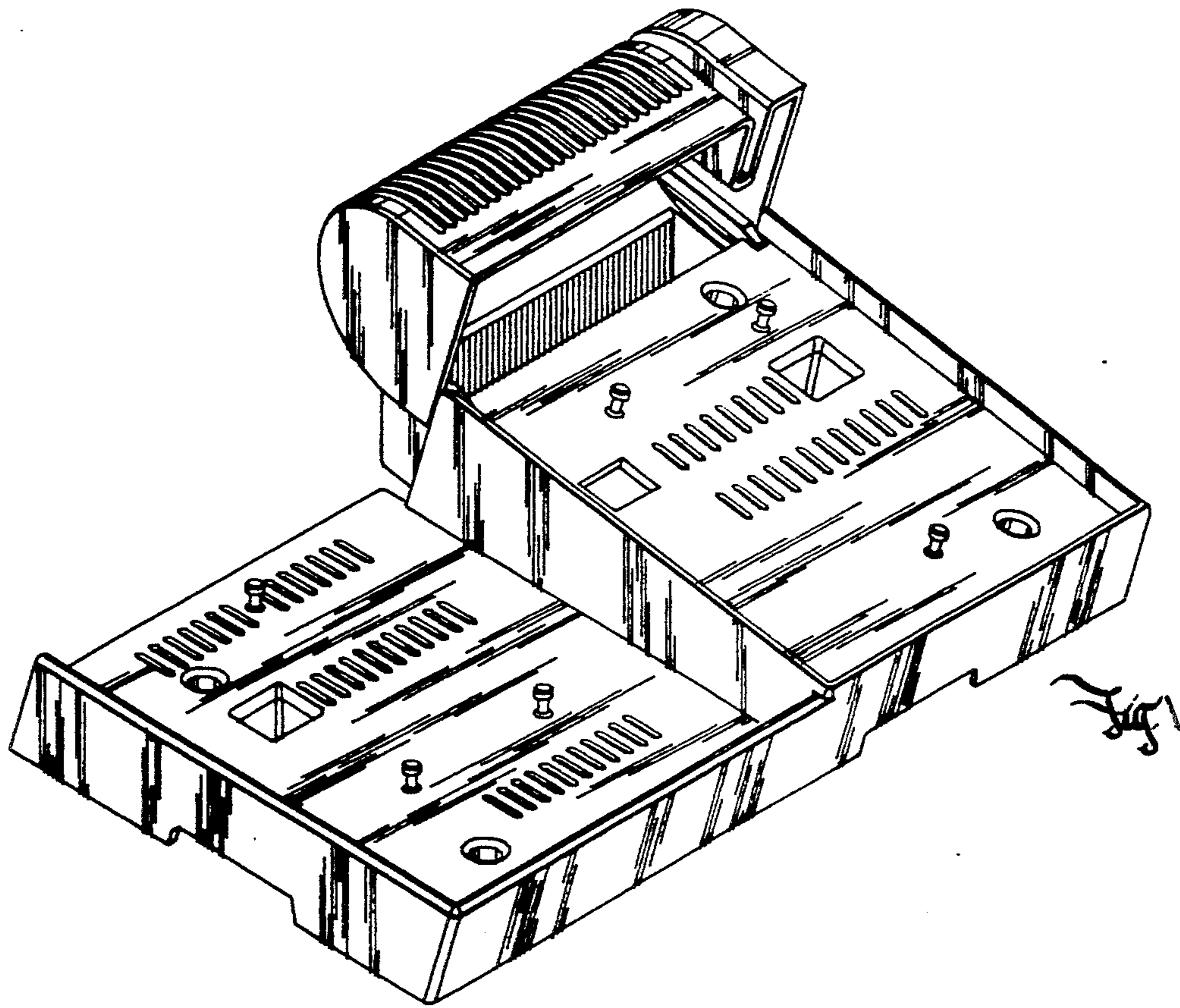



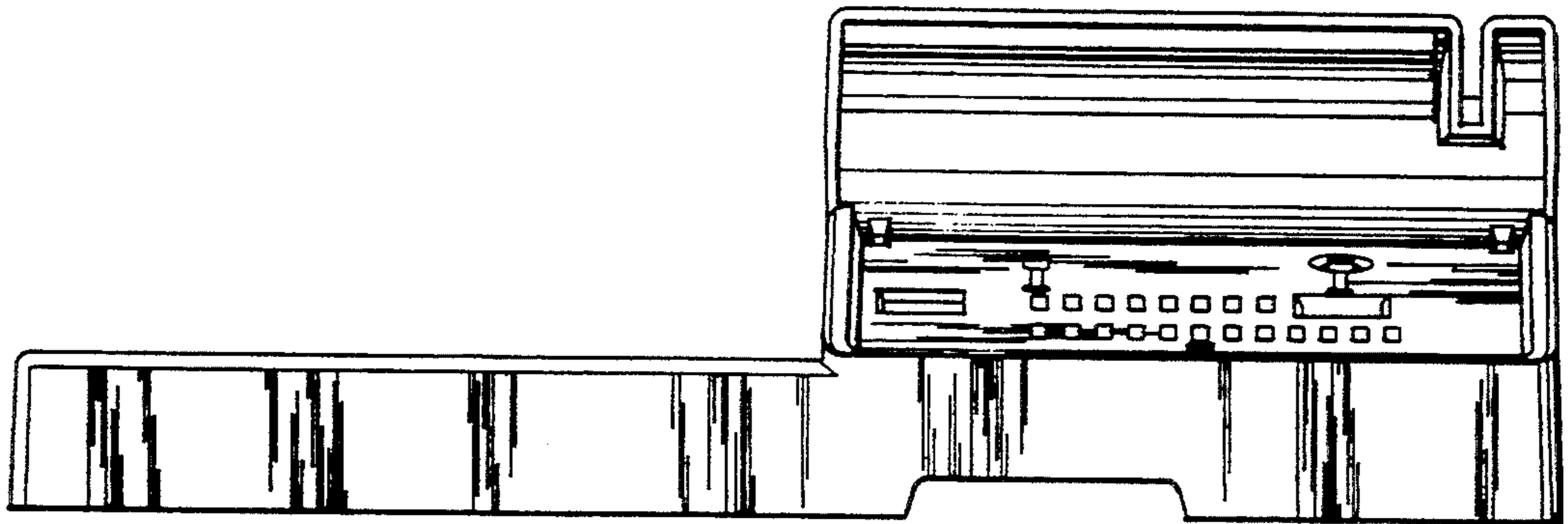

Fig. 3

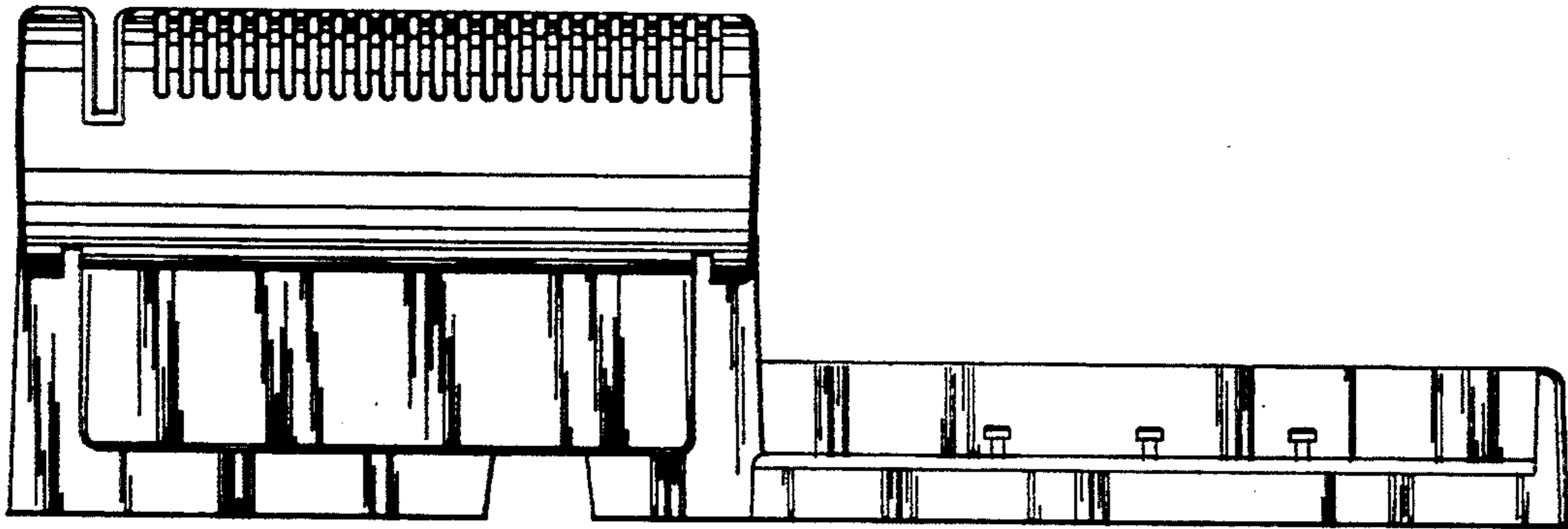

Fig. 4

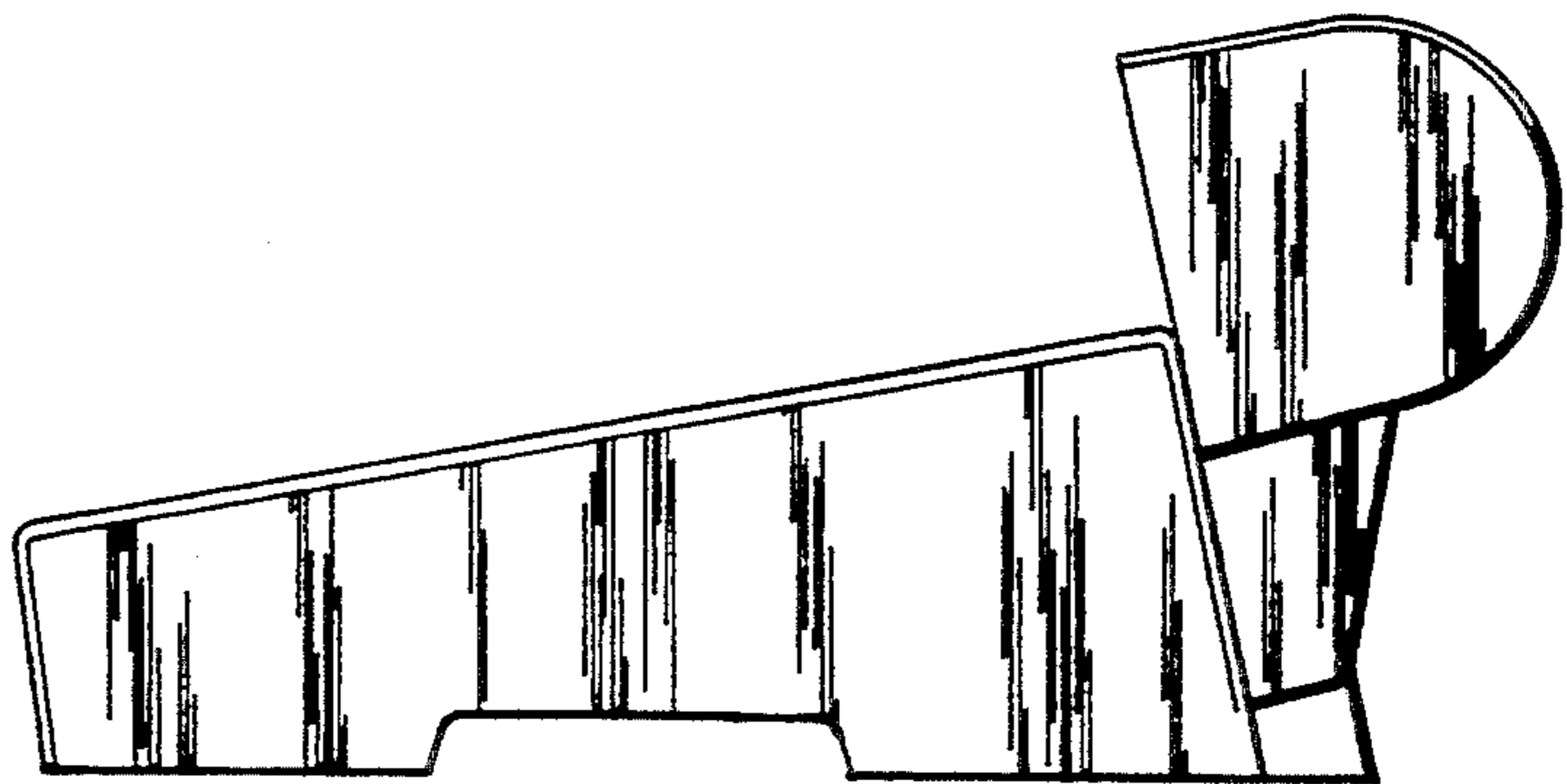

Fig. 5

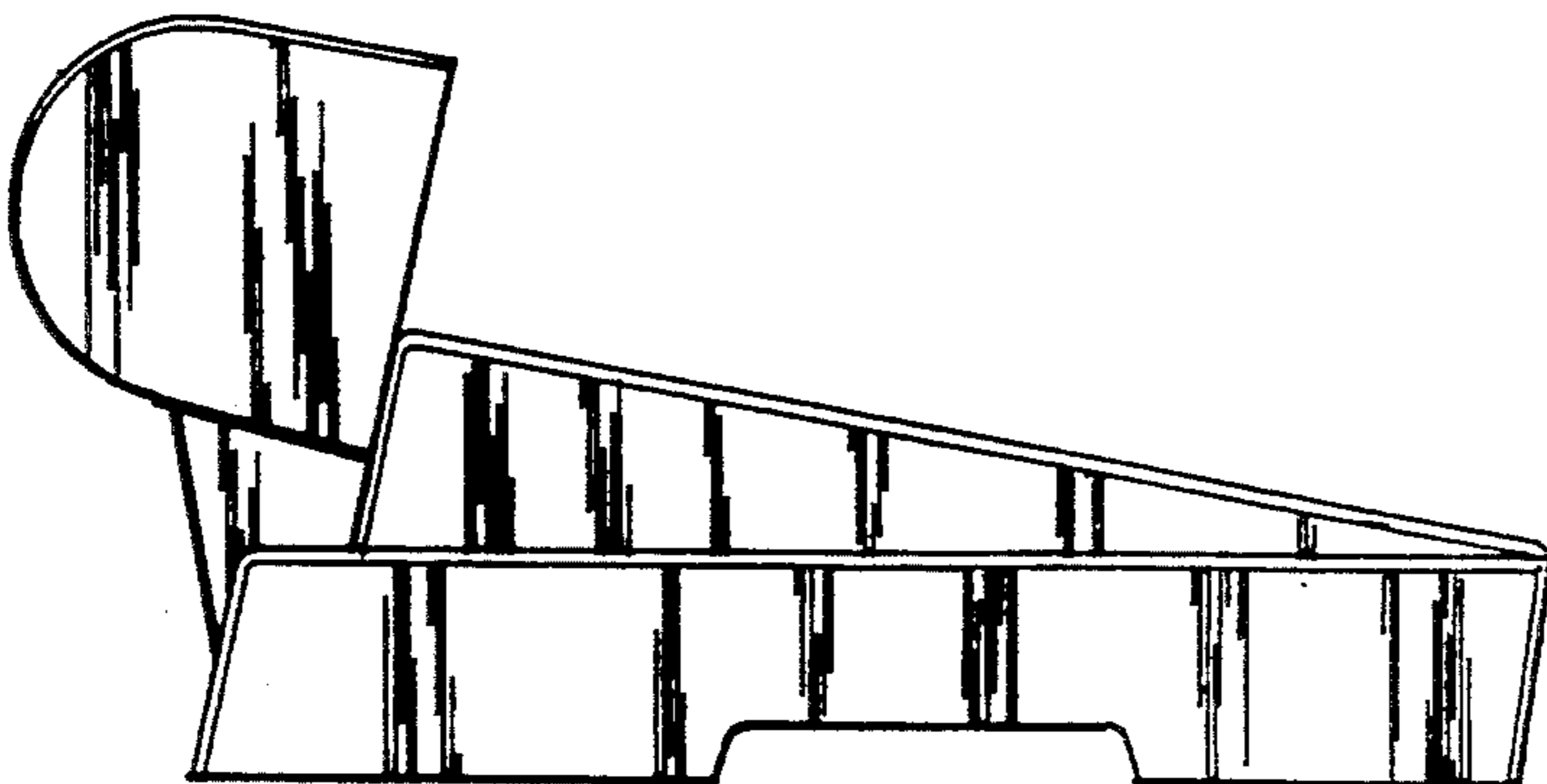

Fig. 6

