



US00D357322S

United States Patent [19]
Matthews

[11] **Patent Number: Des. 357,322**

[45] **Date of Patent: ** Apr. 11, 1995**

[54] **SCALP MASSAGER**

[76] **Inventor: George J. Matthews, 17 Old Coach Rd., Nashua, N.H. 03062**

[**] **Term: 14 Years**

[21] **Appl. No.: 6,844**

[22] **Filed: Mar. 22, 1993**

[52] **U.S. Cl. D24/211; D24/200**

[58] **Field of Search D24/200, 212, 213, 214; 128/24 R, 59, 60, 61, 62 R, 67**

[56] **References Cited**

U.S. PATENT DOCUMENTS

D. 190,896	7/1961	Gerson	D24/211
D. 260,928	9/1981	Gueret	D24/211
D. 303,429	9/1989	Wagoner	D24/211
2,607,064	8/1952	Sullivan et al.	128/62 R
2,655,147	10/1953	Rohrer	128/67

Primary Examiner—Stella Reid
Attorney, Agent, or Firm—William B. Ritchie

[57] **CLAIM**

The ornamental design for a scalp massager, as shown.

DESCRIPTION

FIG. 1 is a top isometric view of a scalp massager, showing my new design;
 FIG. 2 is a bottom plan view thereof;
 FIG. 3 is a bottom isometric view thereof;
 FIG. 4 is a top isometric view of a second embodiment of FIG. 1;
 FIG. 5 is a bottom plan view thereof;
 FIG. 6 is a bottom isometric view thereof;
 FIG. 7 is a cross-sectional view of the embodiment shown in FIG. 4 taken along line 7&8—7&8 of FIG. 10;
 FIG. 8 is a cross-sectional view of the embodiment shown in FIG. 1 taken along line 7&8—7&8 of FIG. 10;
 FIG. 9 is an exploded fragmented view showing the massaging nails;
 FIG. 10 is a top plan view of both embodiments;
 FIG. 11 is a front elevational view of the embodiment shown in FIG. 8; and,
 FIG. 12 is a side elevational view of the embodiment shown in FIG. 8.

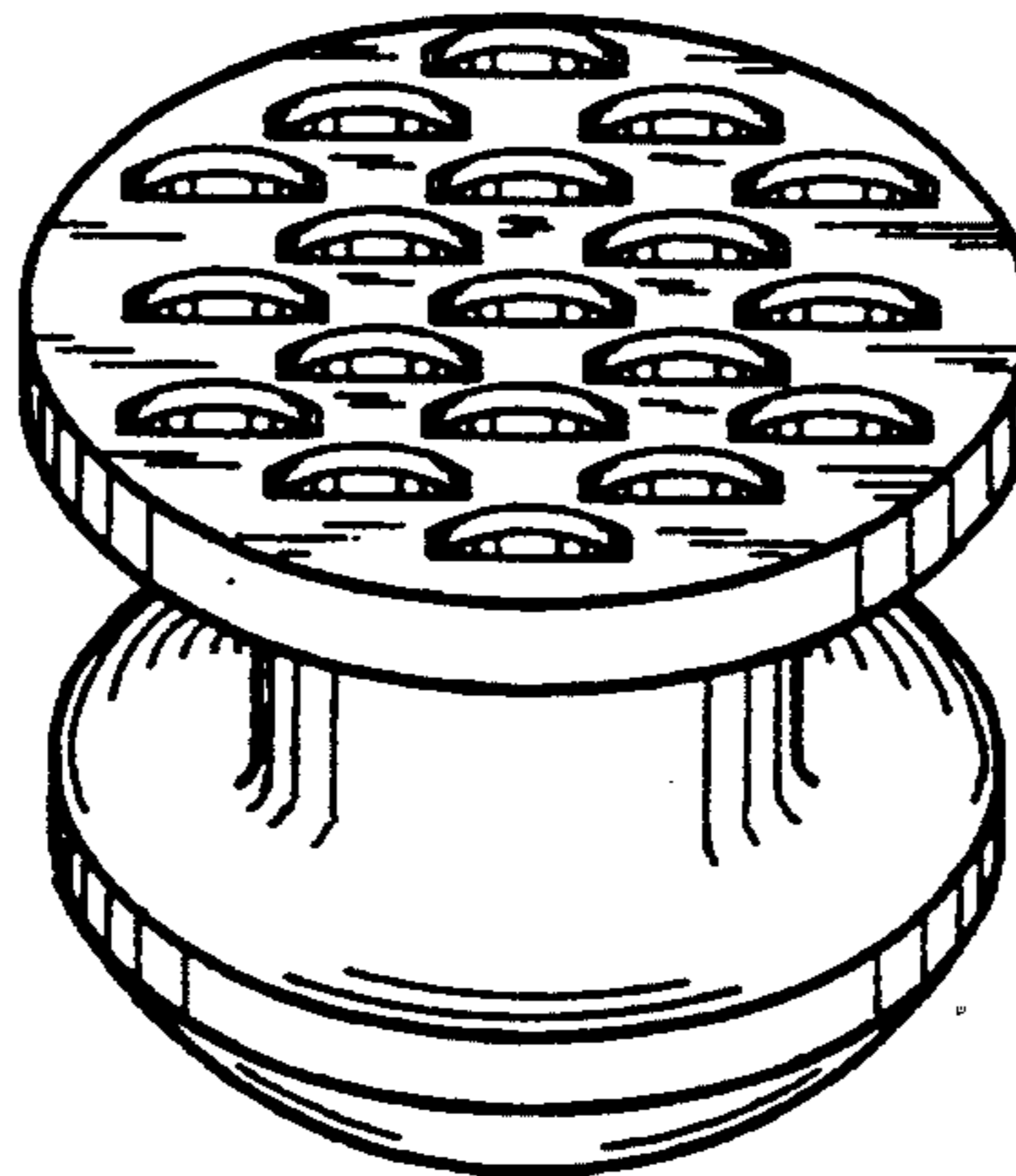
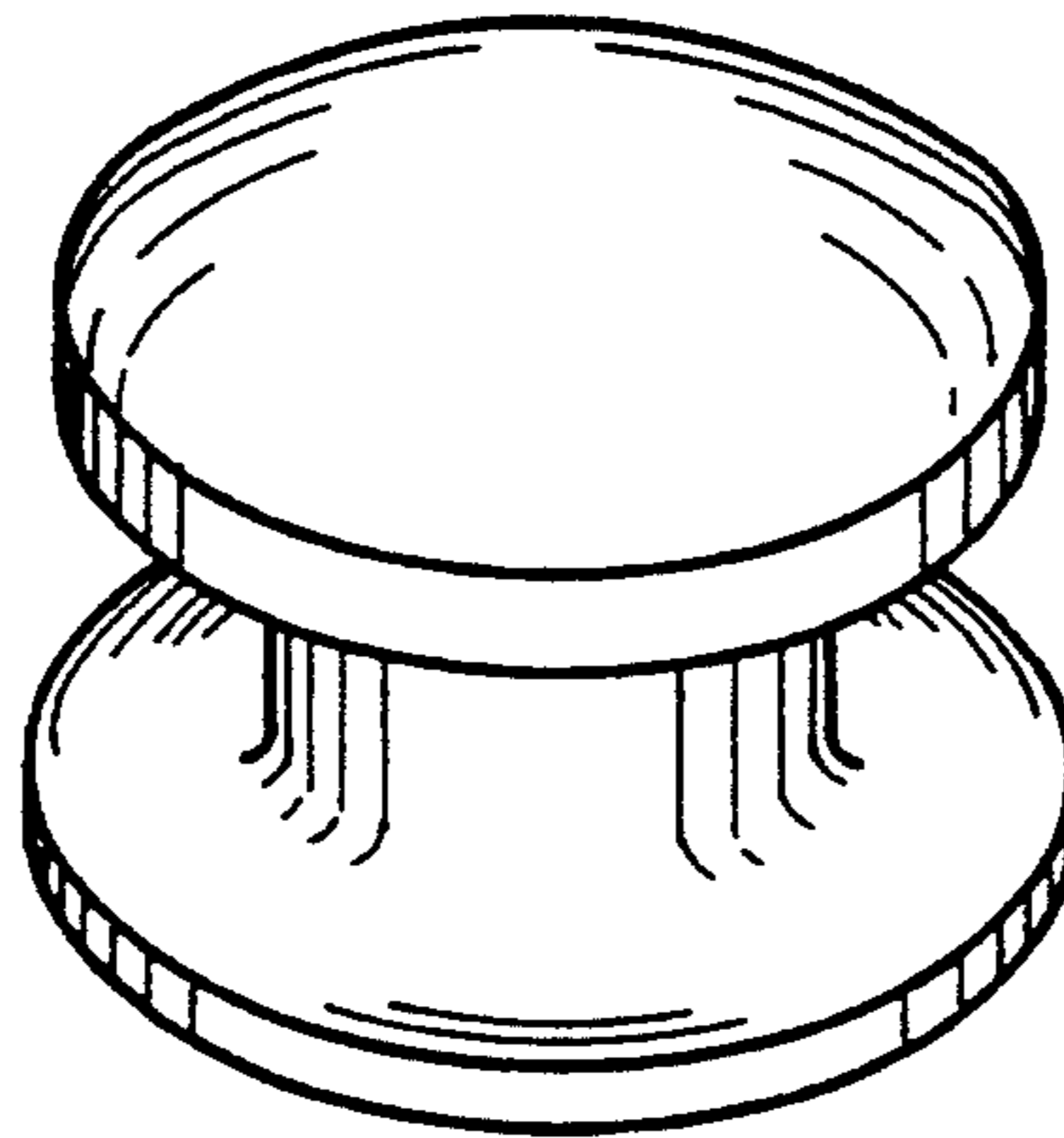

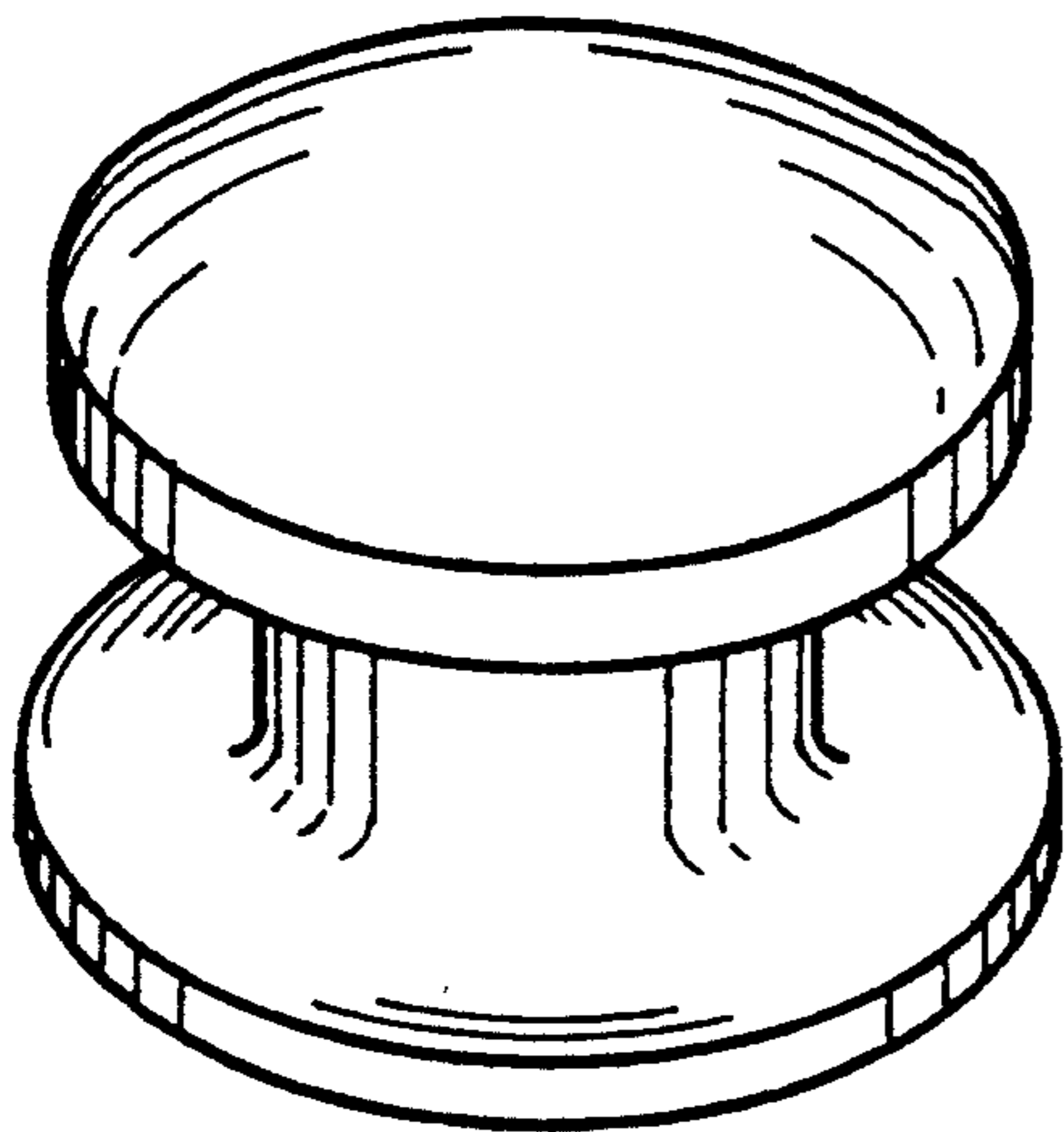

FIG. 1

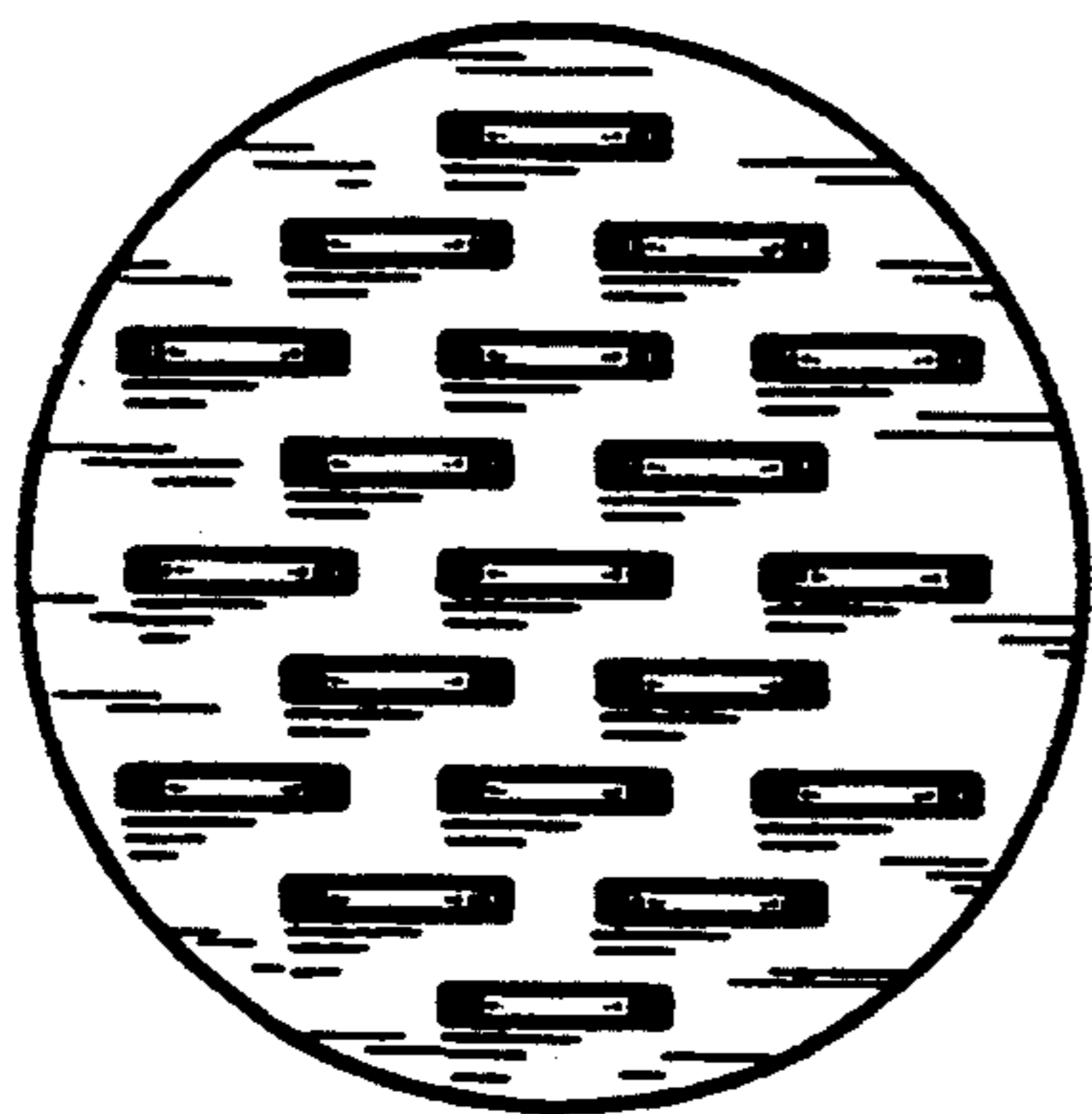

FIG. 2

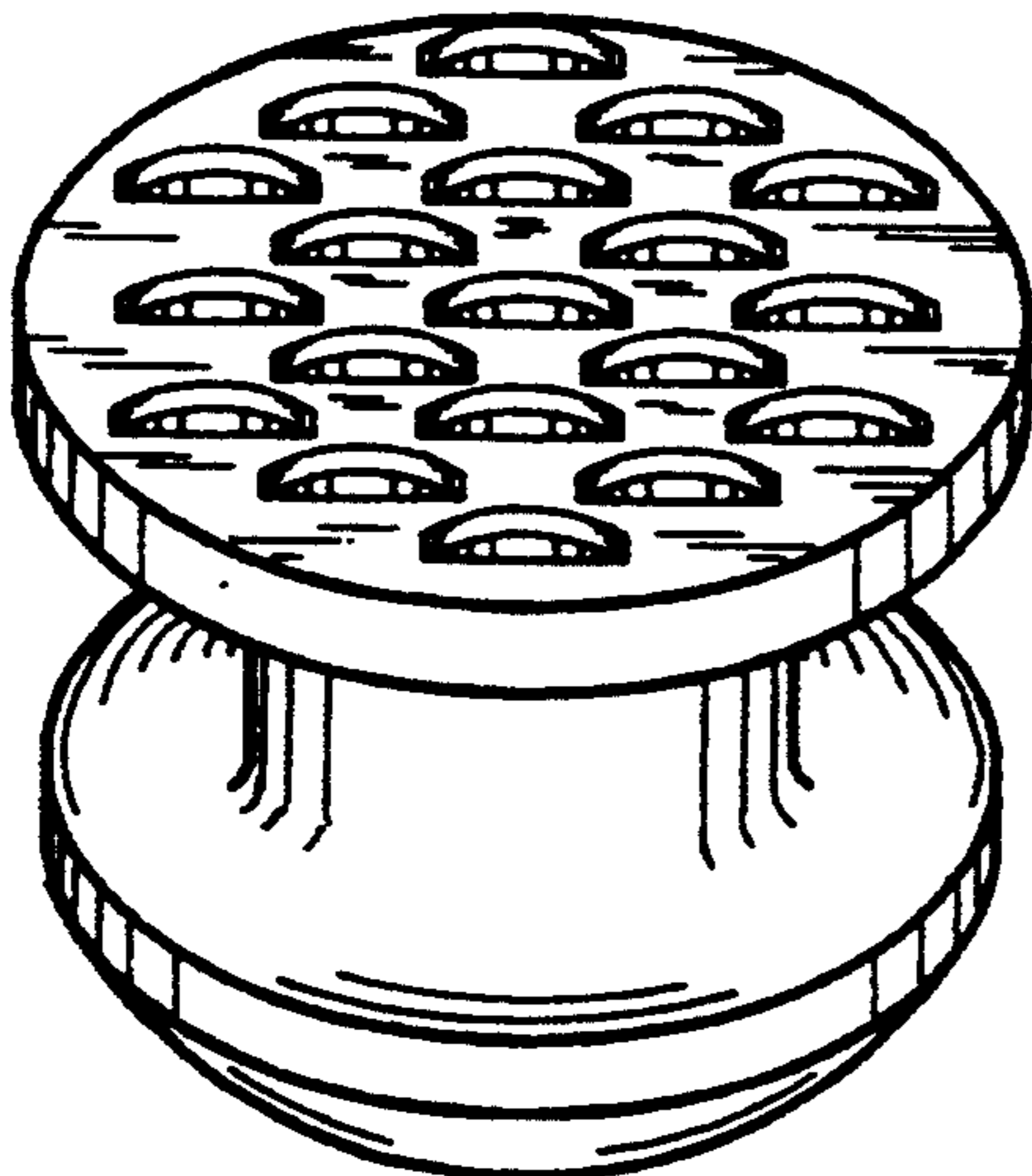

FIG. 3

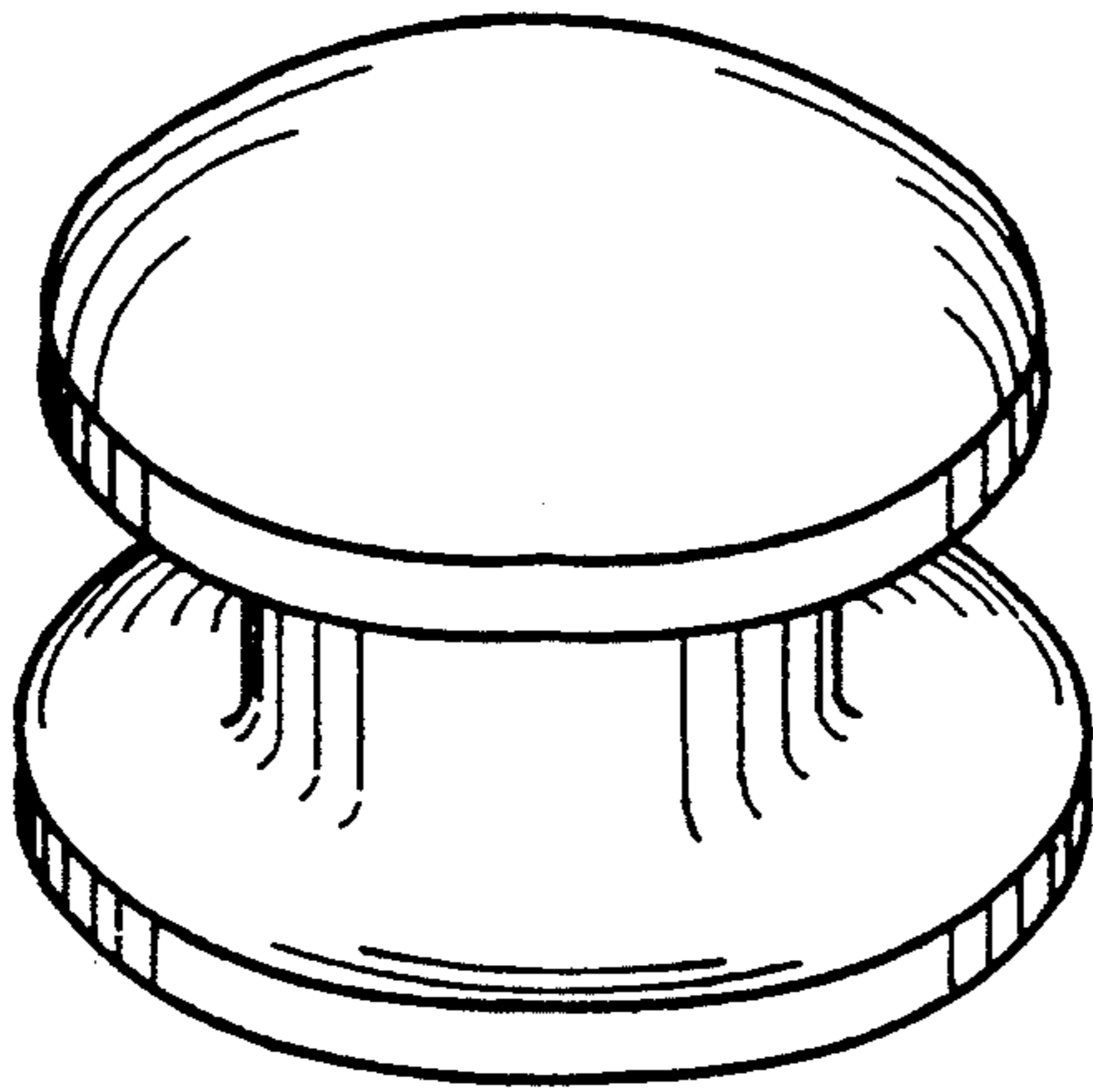

FIG. 4

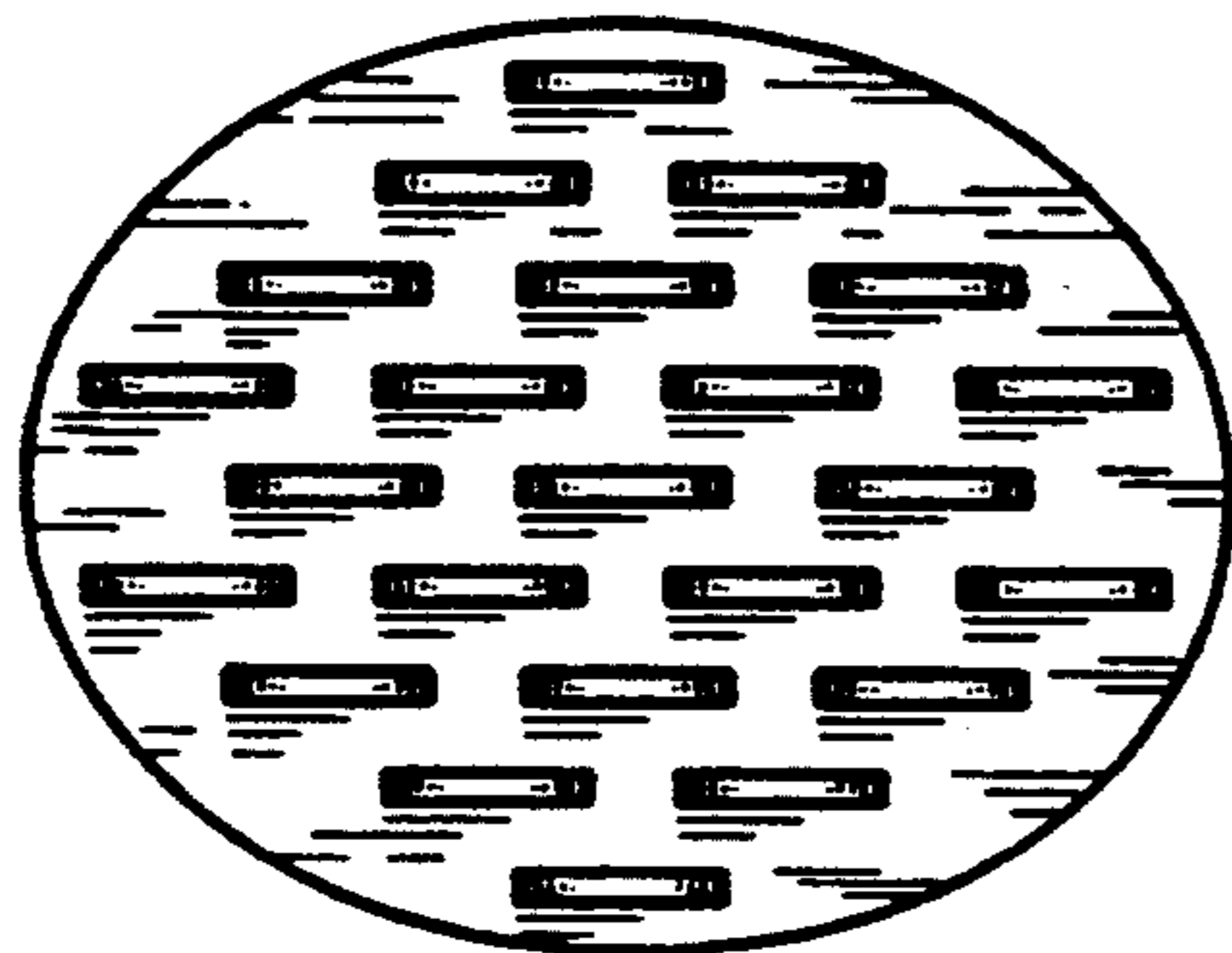

FIG. 5

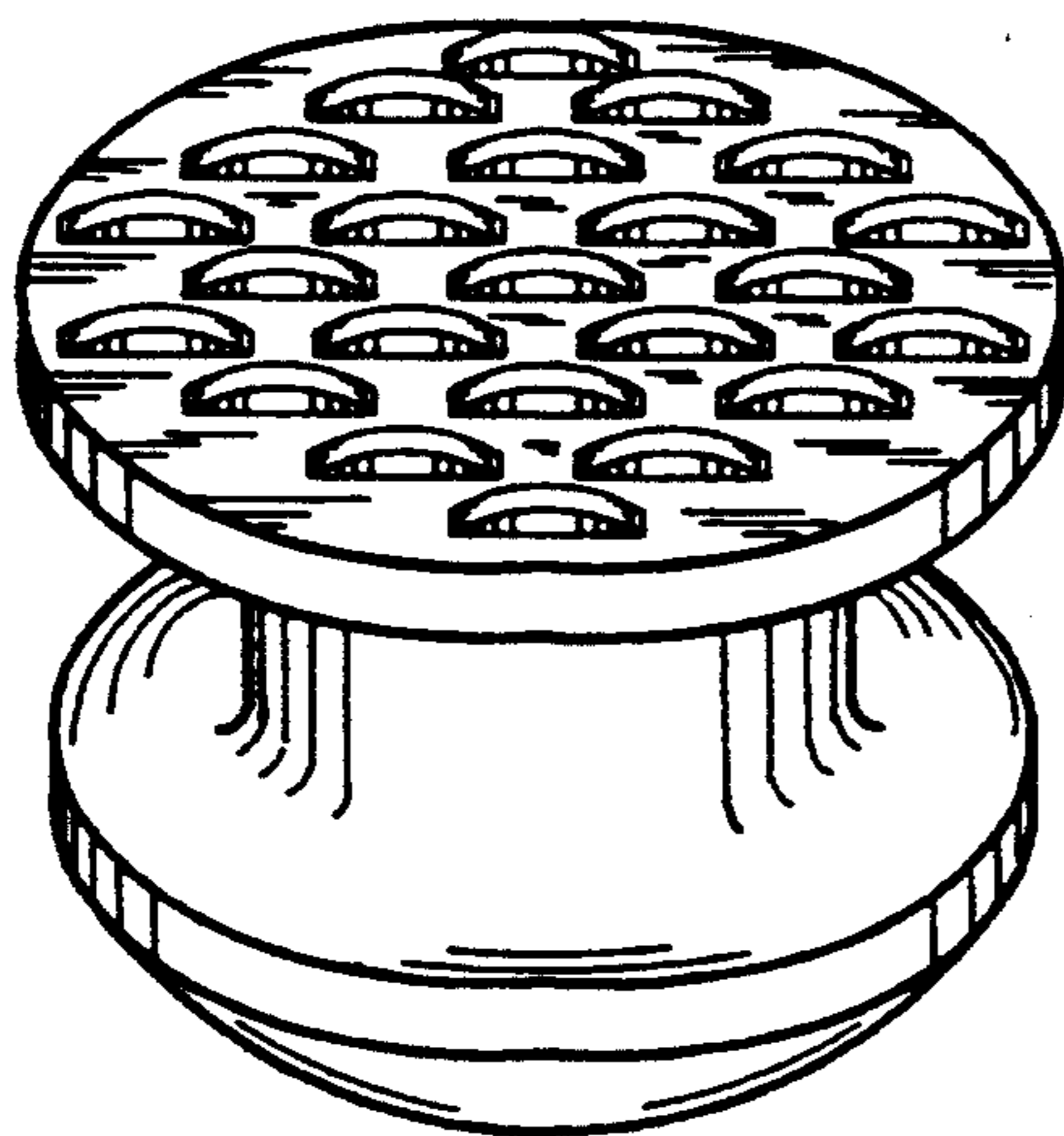

FIG. 6

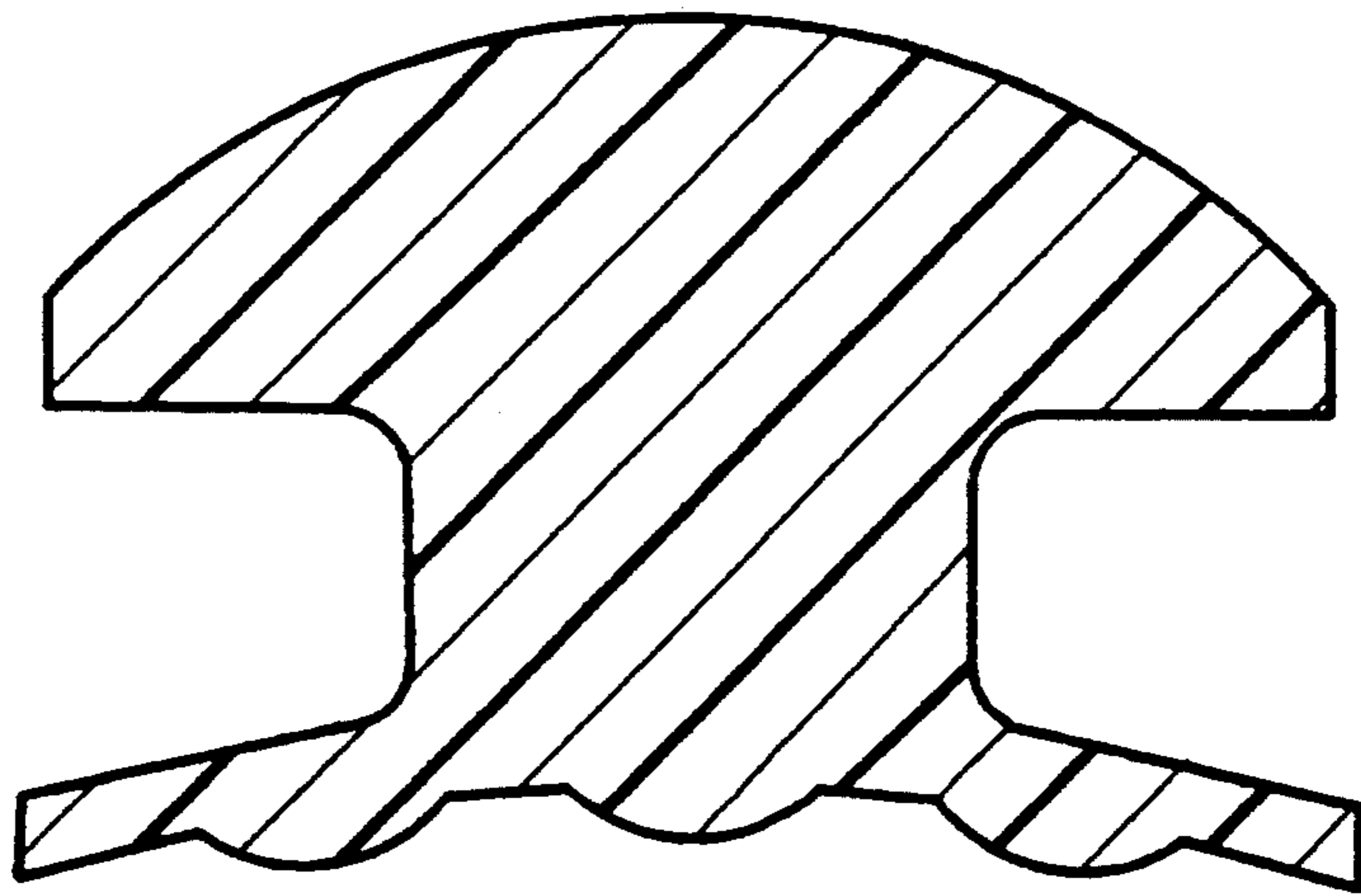

FIG. 7

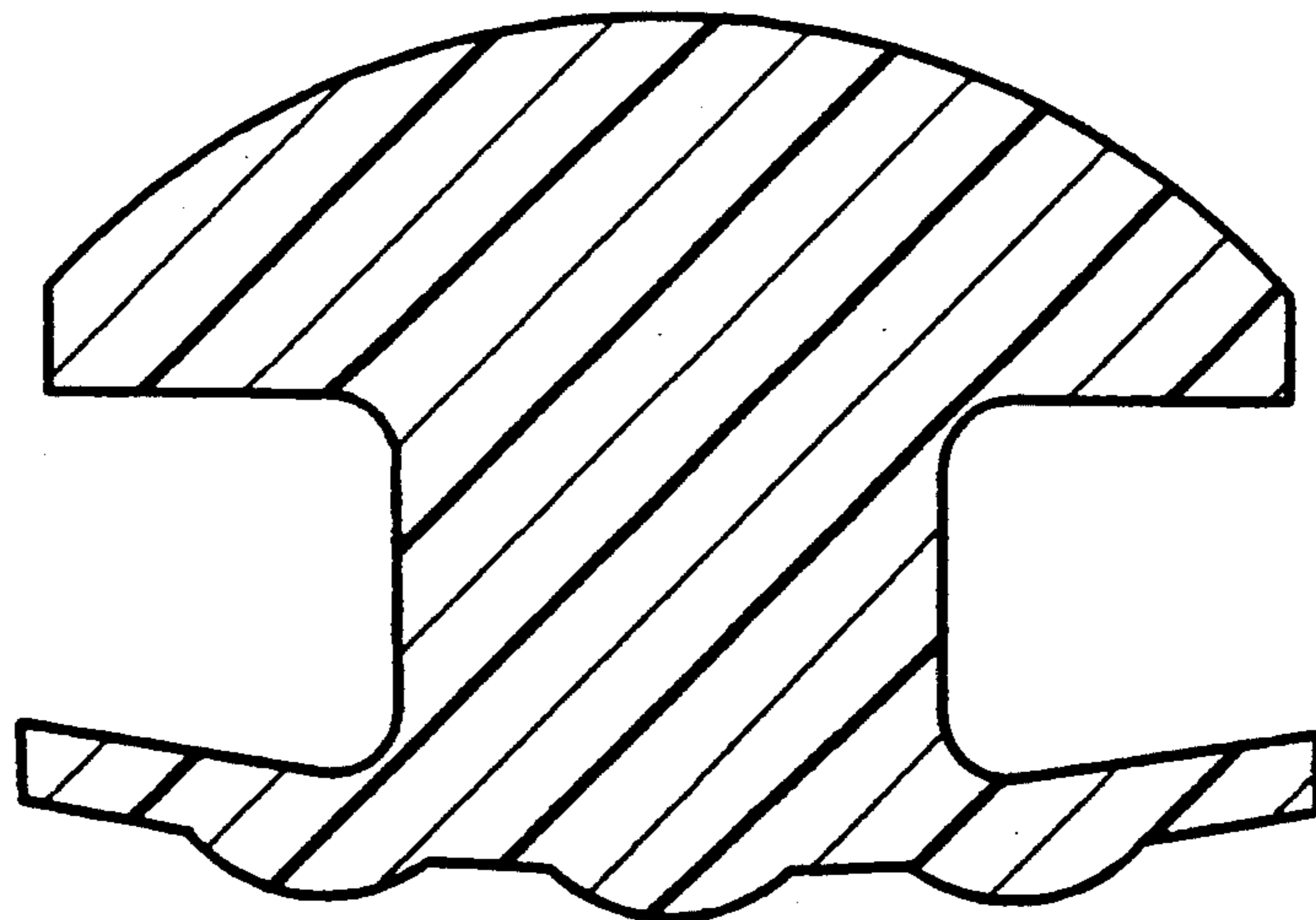

FIG. 8

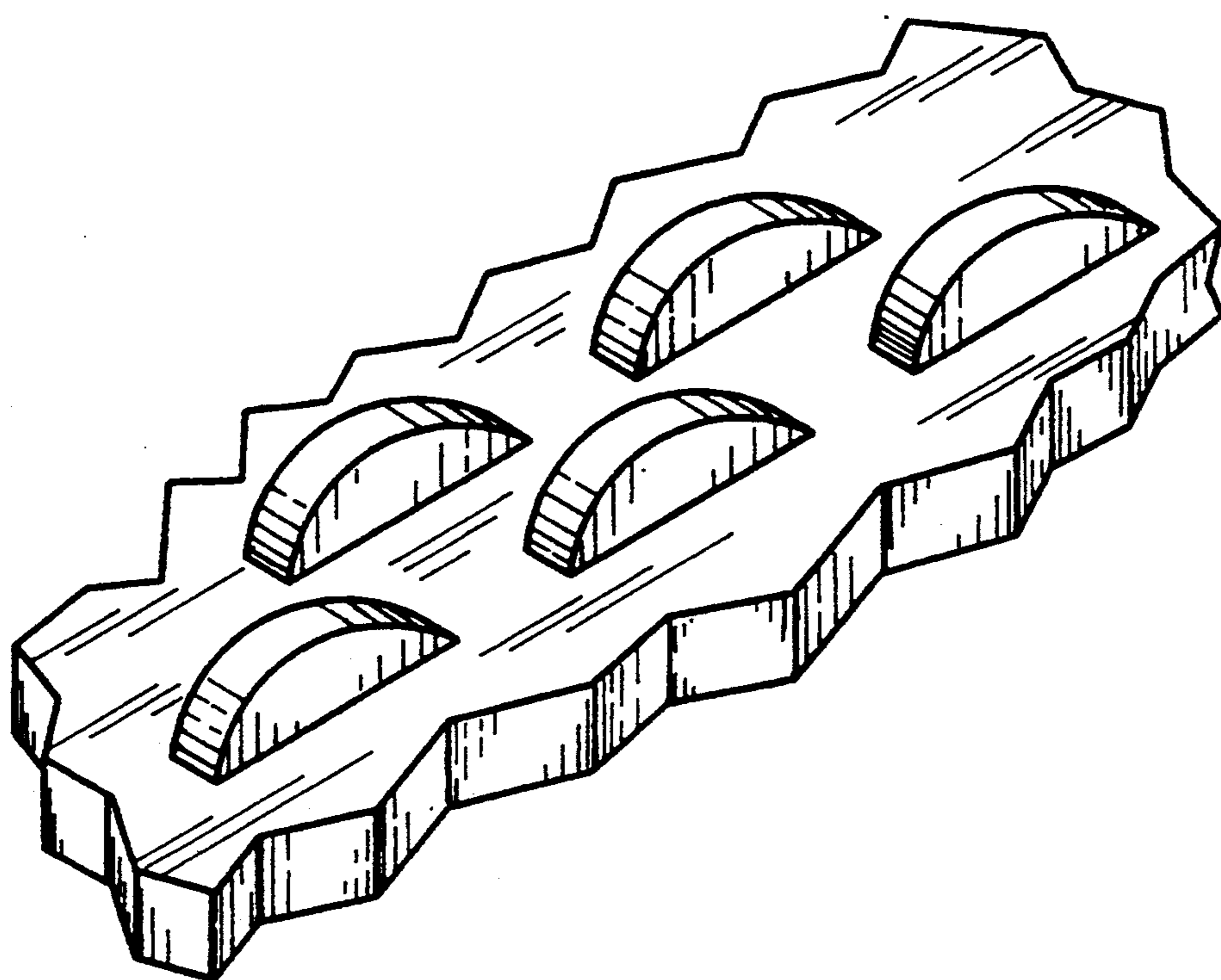

FIG. 9

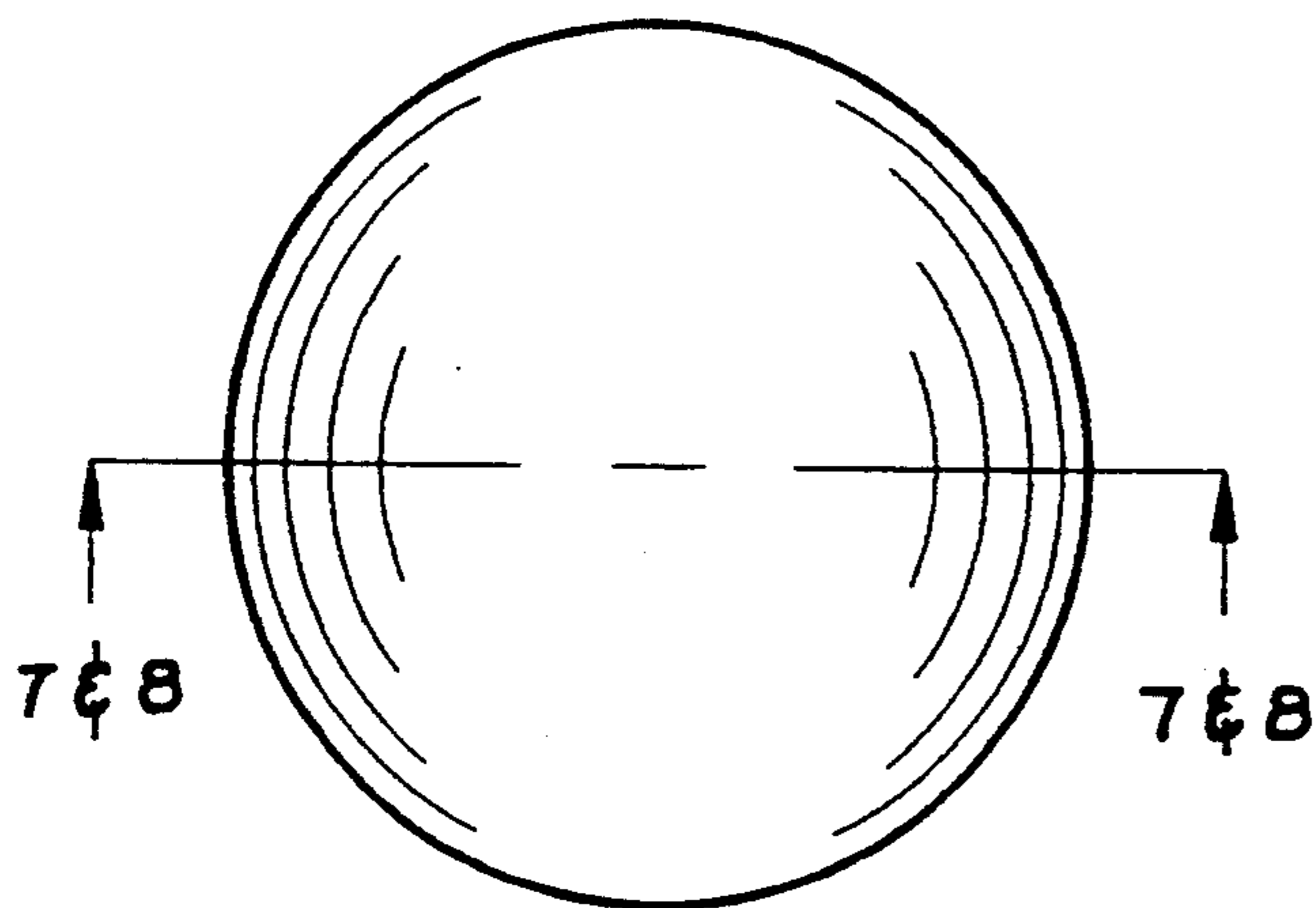

FIG. 10

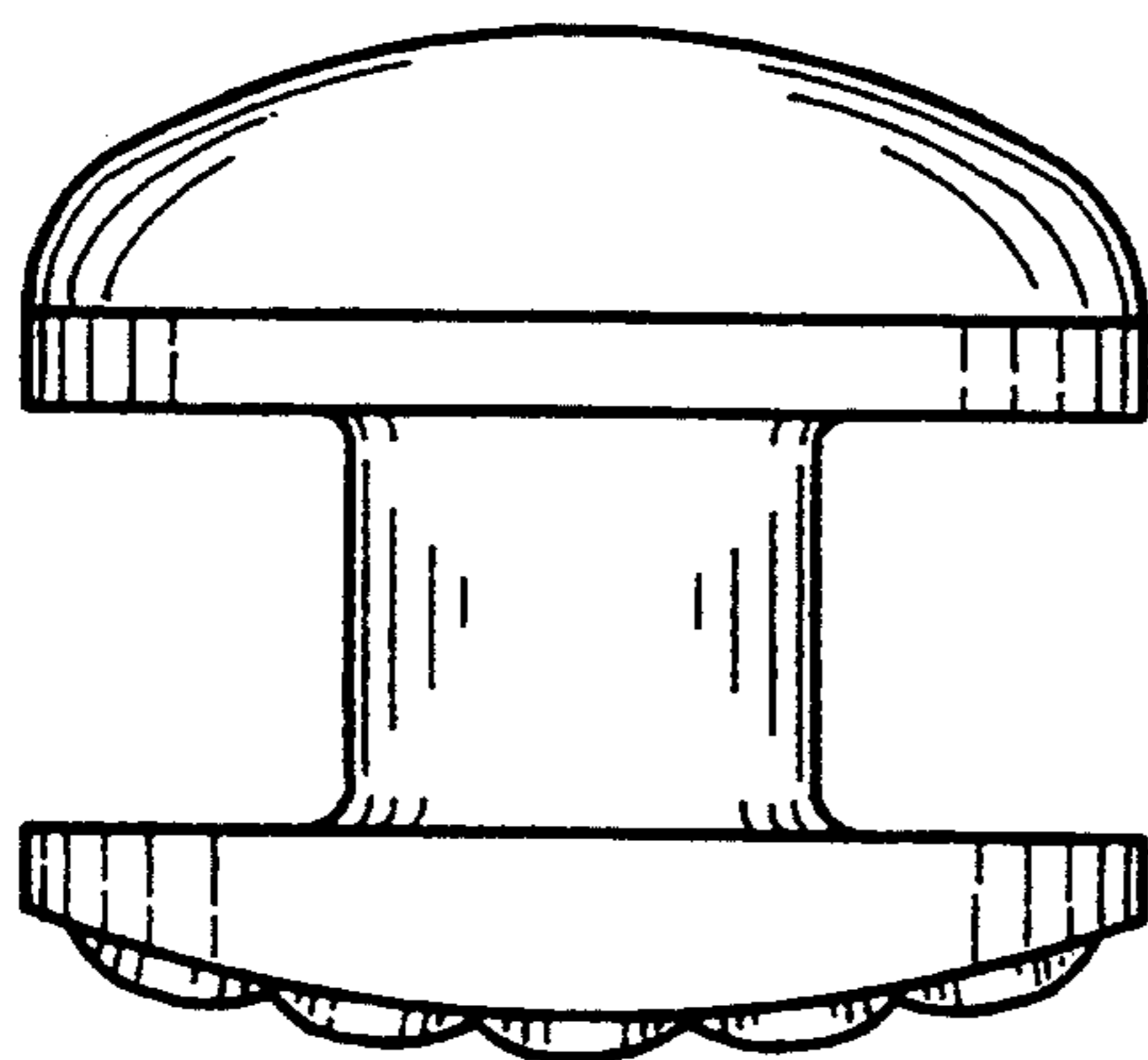

FIG. 11

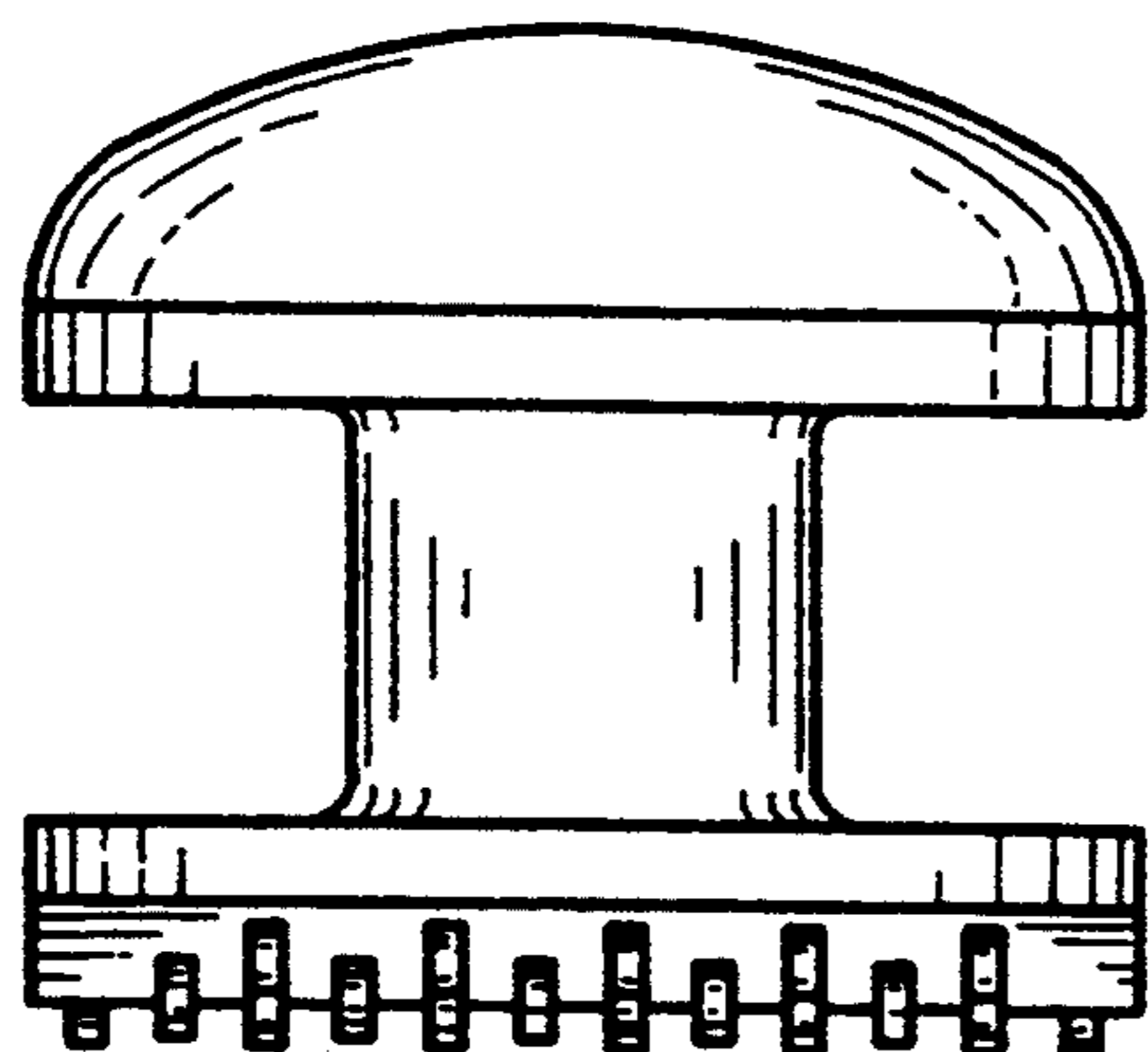

FIG. 12