



US00D357304S

United States Patent [19]

[11] Patent Number: **Des. 357,304**

Haug et al.

[45] Date of Patent: **** Apr. 11, 1995**

[54] **FAUCET HANDLE**

[75] Inventors: **Andreas Haug; Thomas Schoenherr**,
both of Stuttgart, Germany

[73] Assignee: **Masco GmbH**, Germany

[**] Term: **14 Years**

[21] Appl. No.: **11,945**

[22] Filed: **Aug. 18, 1993**

[30] **Foreign Application Priority Data**

Feb. 19, 1993 [DE] Germany M93 01 486.4

Jul. 17, 1993 [DE] Germany M93 05 706.7

[52] U.S. Cl. **D23/252**

[58] Field of Search **D23/238-243,**
D23/249-254; D8/308, 310; 251/291, 292;
4/675-678; 137/801; 16/110 R, 111 R, 114 R,
118, 121, 123, 125, DIG. 24, DIG. 30, DIG. 41

[56] **References Cited**

U.S. PATENT DOCUMENTS

D. 254,088 1/1980 Haug D23/252

D. 339,849 9/1993 Jons D23/252

D. 342,988 1/1994 Jons D23/252

OTHER PUBLICATIONS

Hans Grohe GmbH & Co. KG Catalog, "Klassische

Schönheit. MONDIAL und ATOLL von Hans Grohe.", Form -Nr. 84 000 159, 06/93/50.

Hans Grohe GmbH & Co KG Catalog, "Metropol. Das Ergonomische Mischerprogramm", Form-Nr. 84 000 177 7/93/200.

Delta Faucet Company, Single page, "We Still Build 'Em Like We Used to, Only Better", 1983.

Primary Examiner—A. Hugo Word

Assistant Examiner—E. Watterson

Attorney, Agent, or Firm—Eckert Seamans Cherin & Mellott

[57] **CLAIM**

The ornamental design for a faucet handle, as shown and described.

DESCRIPTION

FIG. 1 is a side perspective view of a faucet handle showing my new design;

FIG. 2 is a front elevation view thereof;

FIG. 3 is a rear elevation view thereof;

FIG. 4 is a side elevation view thereof;

FIG. 5 is a top plan view thereof;

FIG. 6 is an opposite side elevation view thereof; and,

FIG. 7 is a bottom plan view thereof.

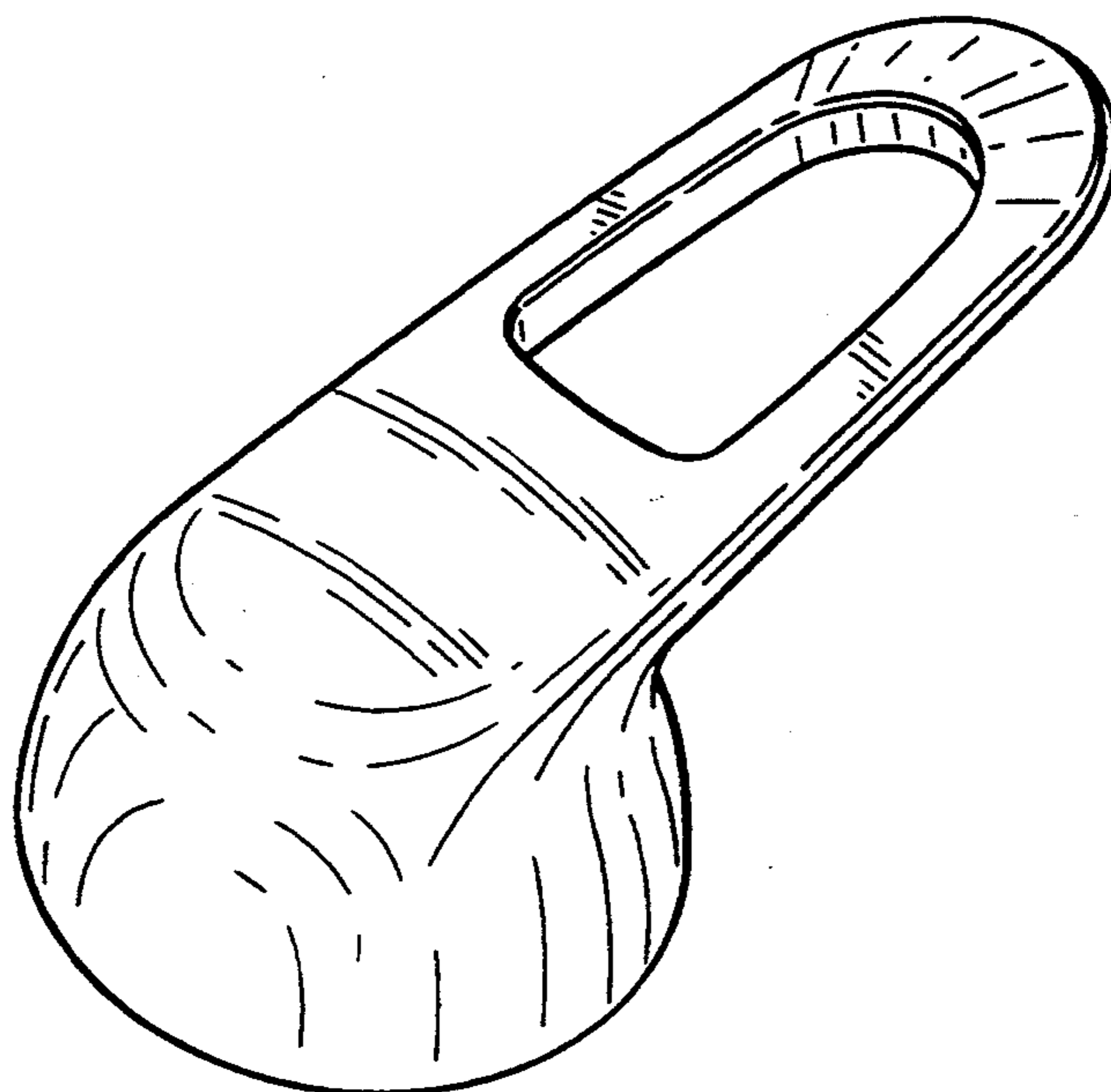

Fig. 1

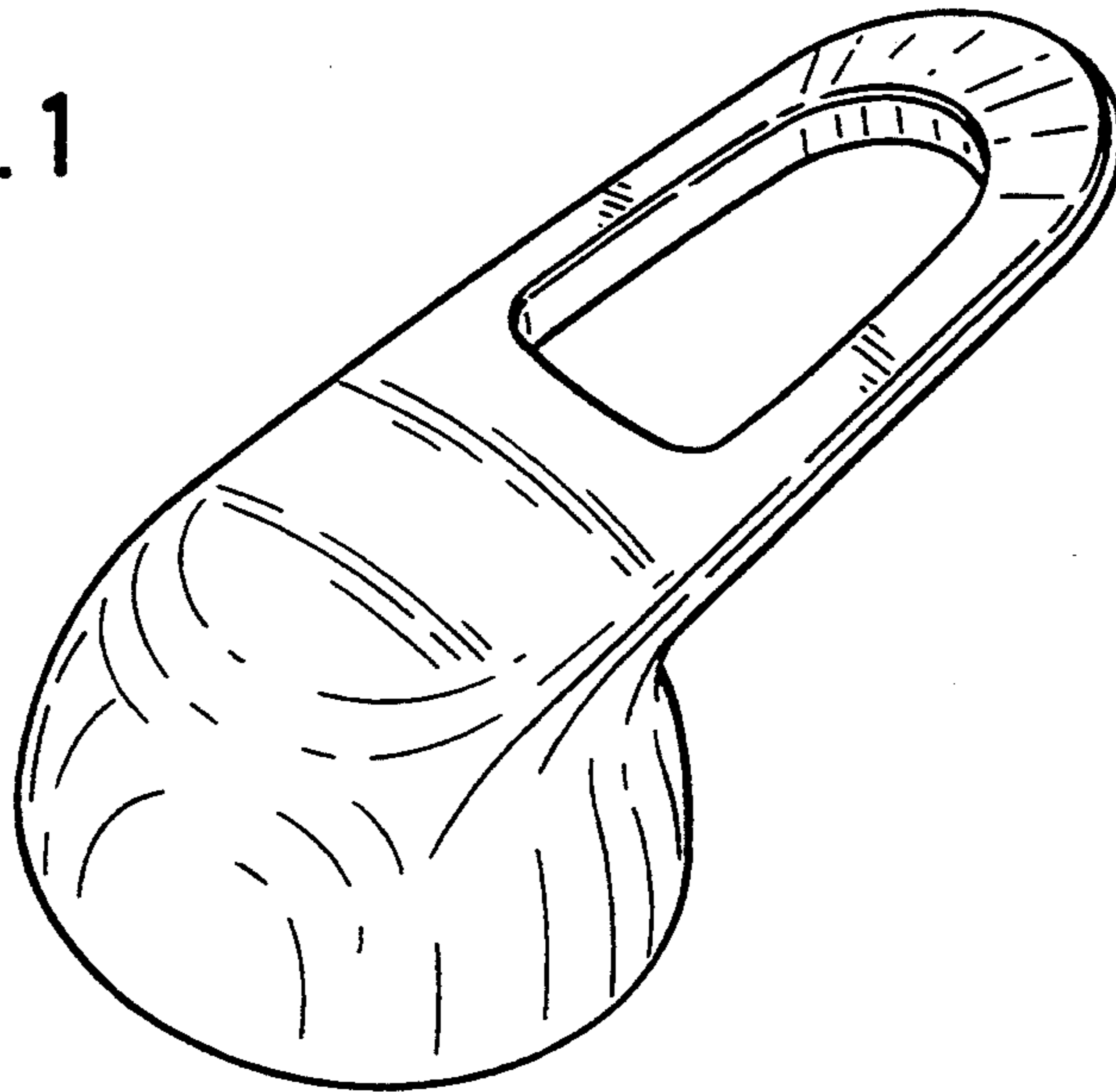

Fig. 2

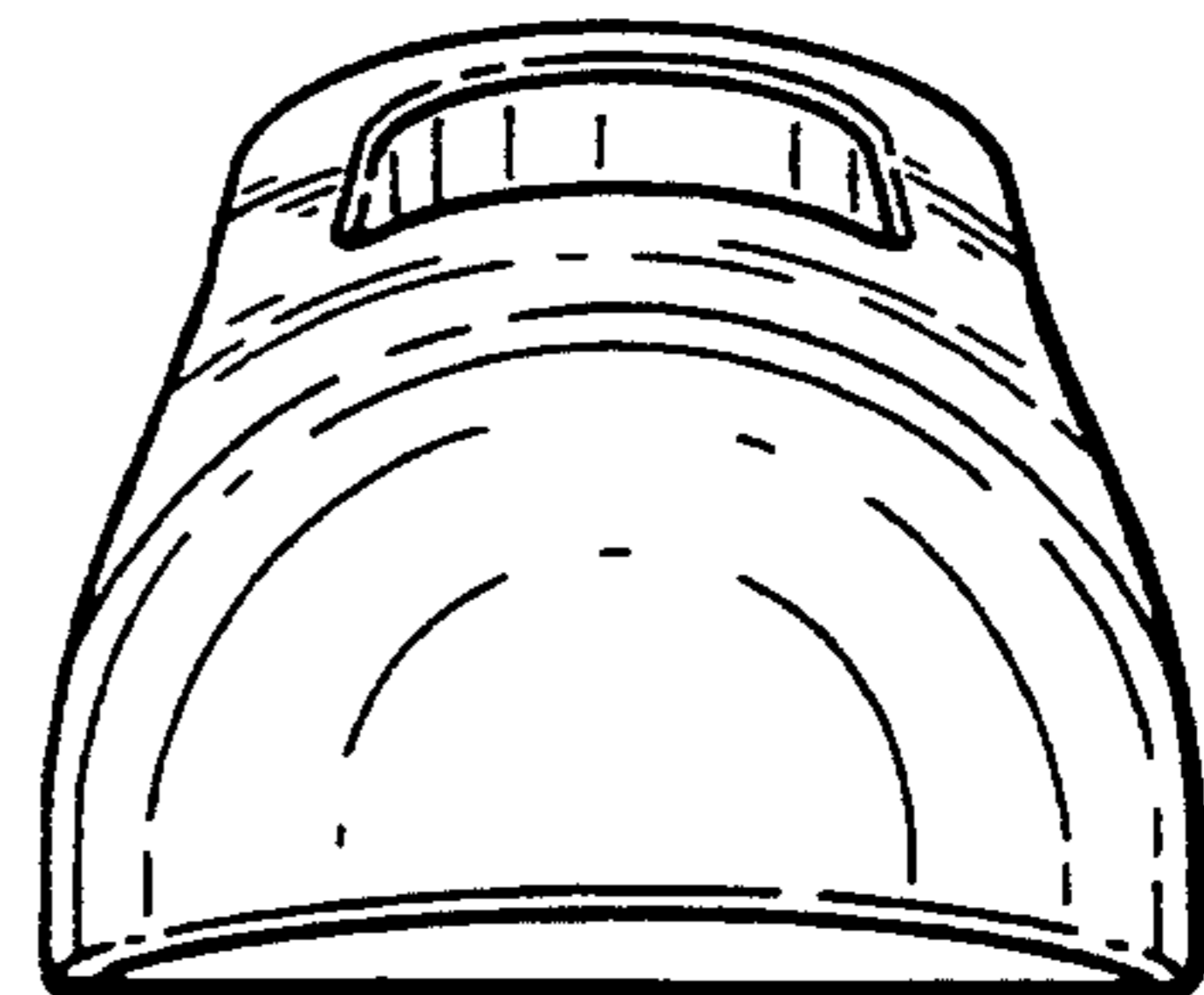
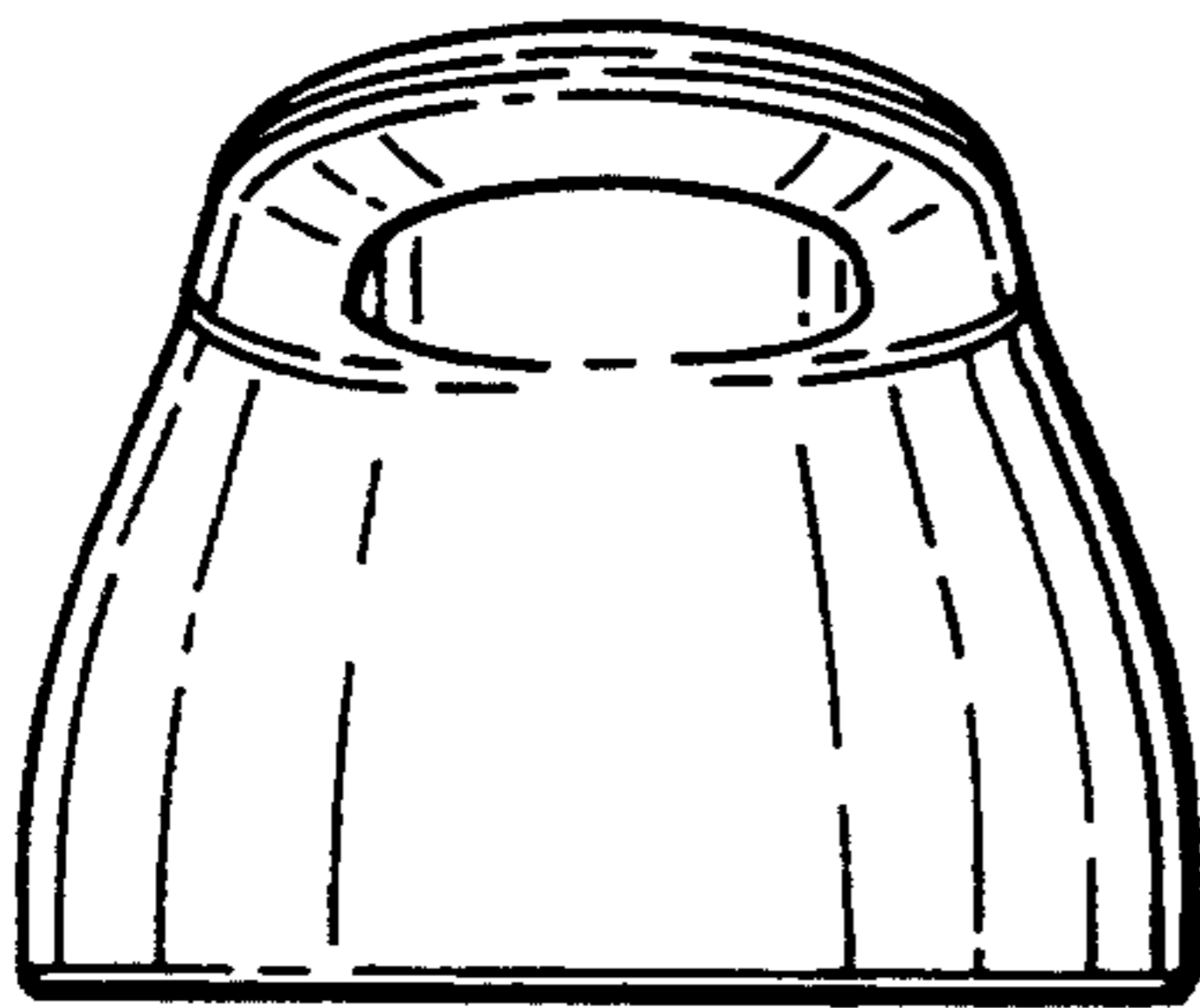

Fig. 3

FIG. 4

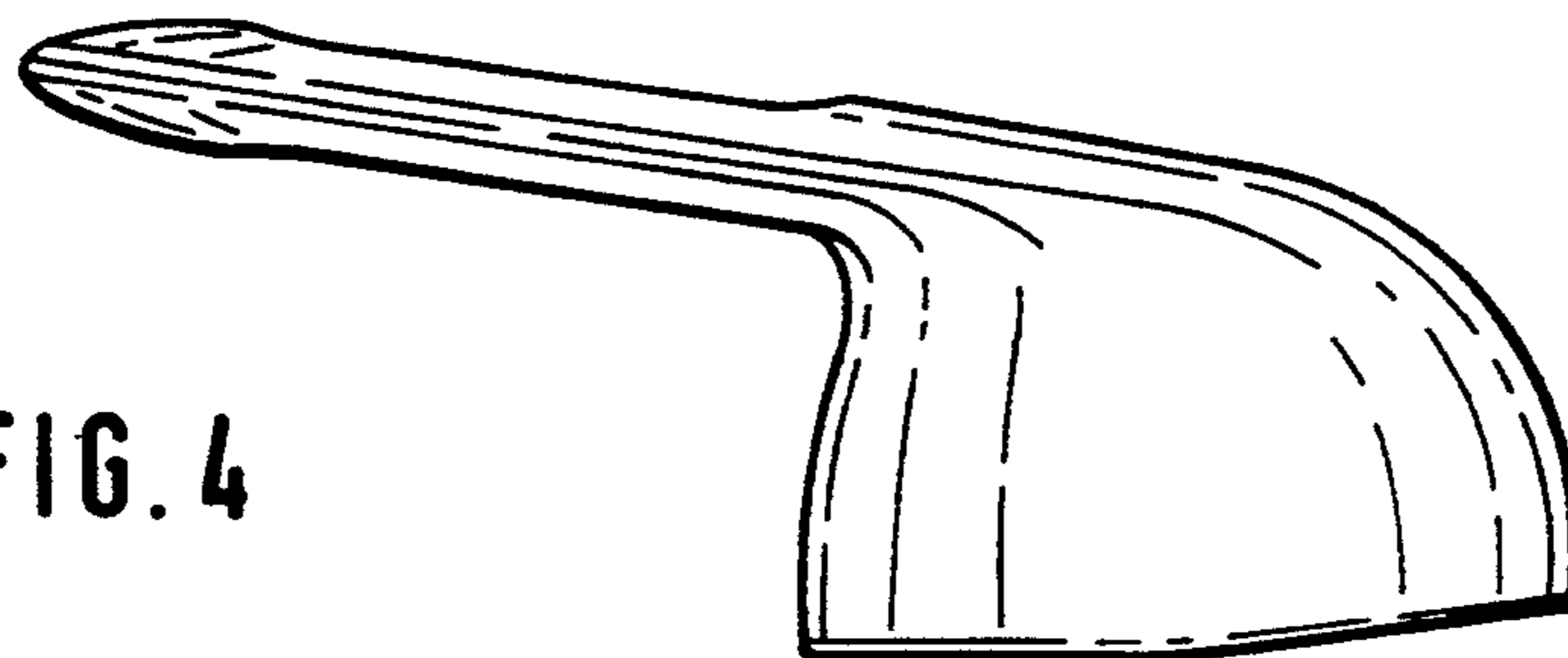

Fig. 5

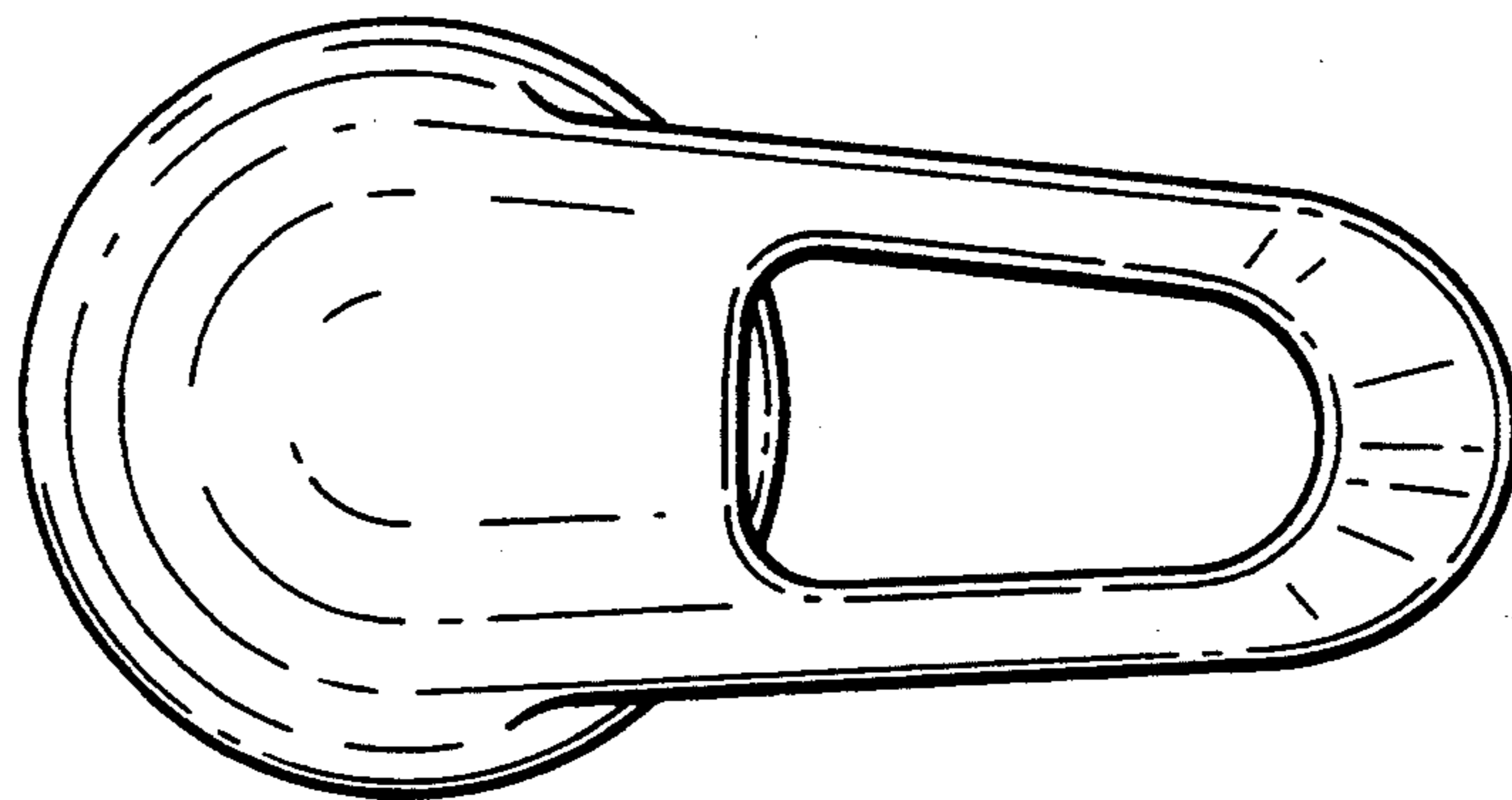

Fig. 6

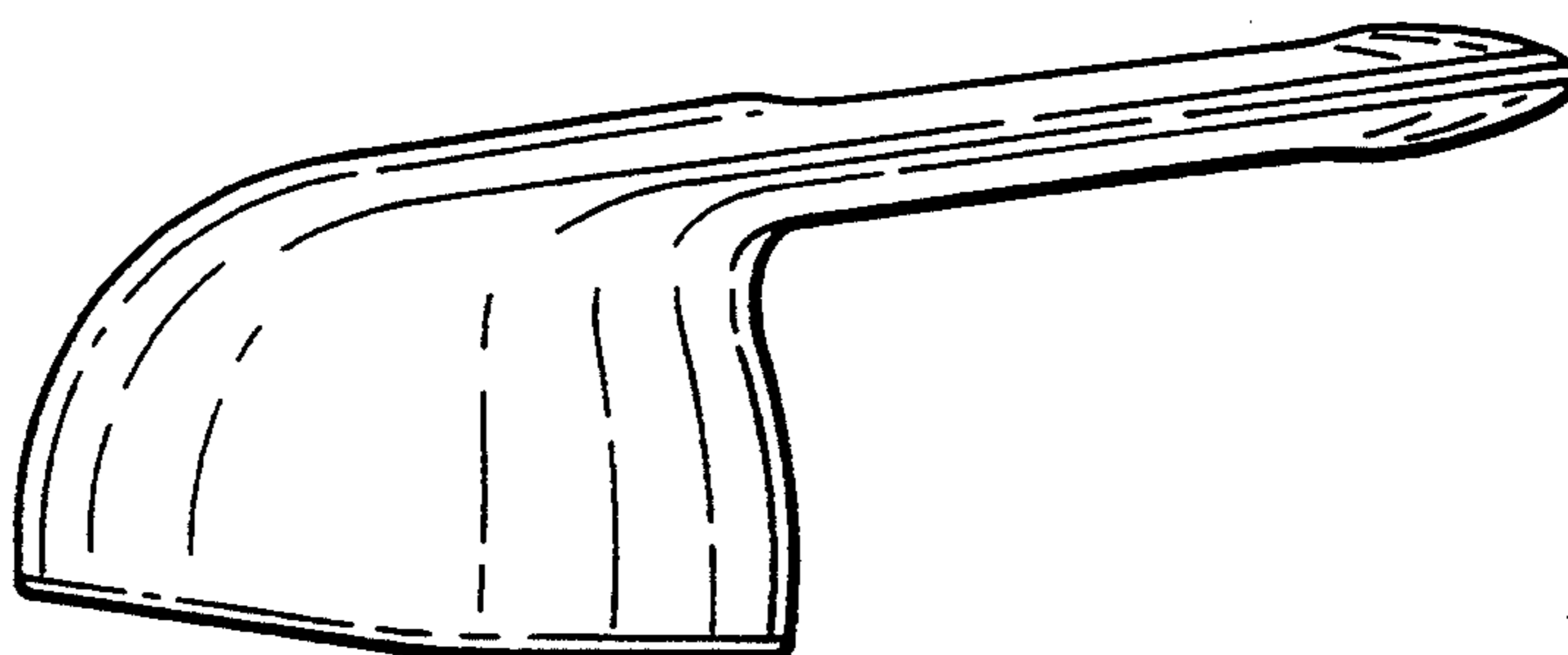

Fig. 7

