



US00D357232S

United States Patent [19]

[11] Patent Number: Des. 357,232

Merino

[45] Date of Patent: ** Apr. 11, 1995

[54] COMPUTER HOUSING

DESCRIPTION

[75] Inventor: **Tristan A. Merino**, Austin, Tex.

FIG. 1 is a top plan view of a computer housing with the front panel cover being open;

[73] Assignee: **International Business Machines Corporation**, Armonk, N.Y.

FIG. 2 is a top plan view thereof, the front panel cover being closed;

[**] Term: **14 Years**

FIG. 3 is a bottom plan view thereof, the front panel cover being open;

[21] Appl. No.: **14,974**

FIG. 4 is a bottom plan view thereof, the front panel cover being closed;

[22] Filed: **Nov. 5, 1993**

FIG. 5 is a right side elevational view thereof the front panel cover being open;

[52] U.S. Cl. **D14/100**

FIG. 6 is a right side elevational view thereof the front panel cover being closed;

[58] Field of Search **D14/100, 102, 107-109, D14/125; D13/162, 184, 199; 360/97.01, 97.04, 98.01, 99.01, 99.12; 361/600, 622, 724-728**

FIG. 7 is a left side elevational view thereof the front panel cover being open;

[56] References Cited

FIG. 8 is a left side elevational view thereof the front panel cover being closed;

U.S. PATENT DOCUMENTS

D. 313,230	12/1990	Isaacs	D14/125
D. 320,978	10/1991	Cronch et al.	D14/100
D. 340,444	10/1993	Kuba et al.	D14/100
D. 346,157	4/1994	Jordan, III	D14/100
D. 347,420	5/1994	Yamazaki	D14/100

FIG. 9 is a front elevational view thereof the front panel cover being open;

Primary Examiner—Freda S. Nunn

FIG. 10 is a front elevational view thereof the front panel cover being closed;

Attorney, Agent, or Firm—Paul S. Drake

FIG. 11 is a top, front, right side perspective view thereof, the front panel cover being open;

[57] CLAIM

FIG. 12 is a top, front, right side perspective view thereof, the front panel cover being closed;

The ornamental design for a computer housing, as shown and described.

FIG. 13 is a bottom, front, left side perspective view thereof, the front panel cover being open; and,

FIG. 14 is a bottom, front, left side perspective view thereof, the front panel cover being closed.

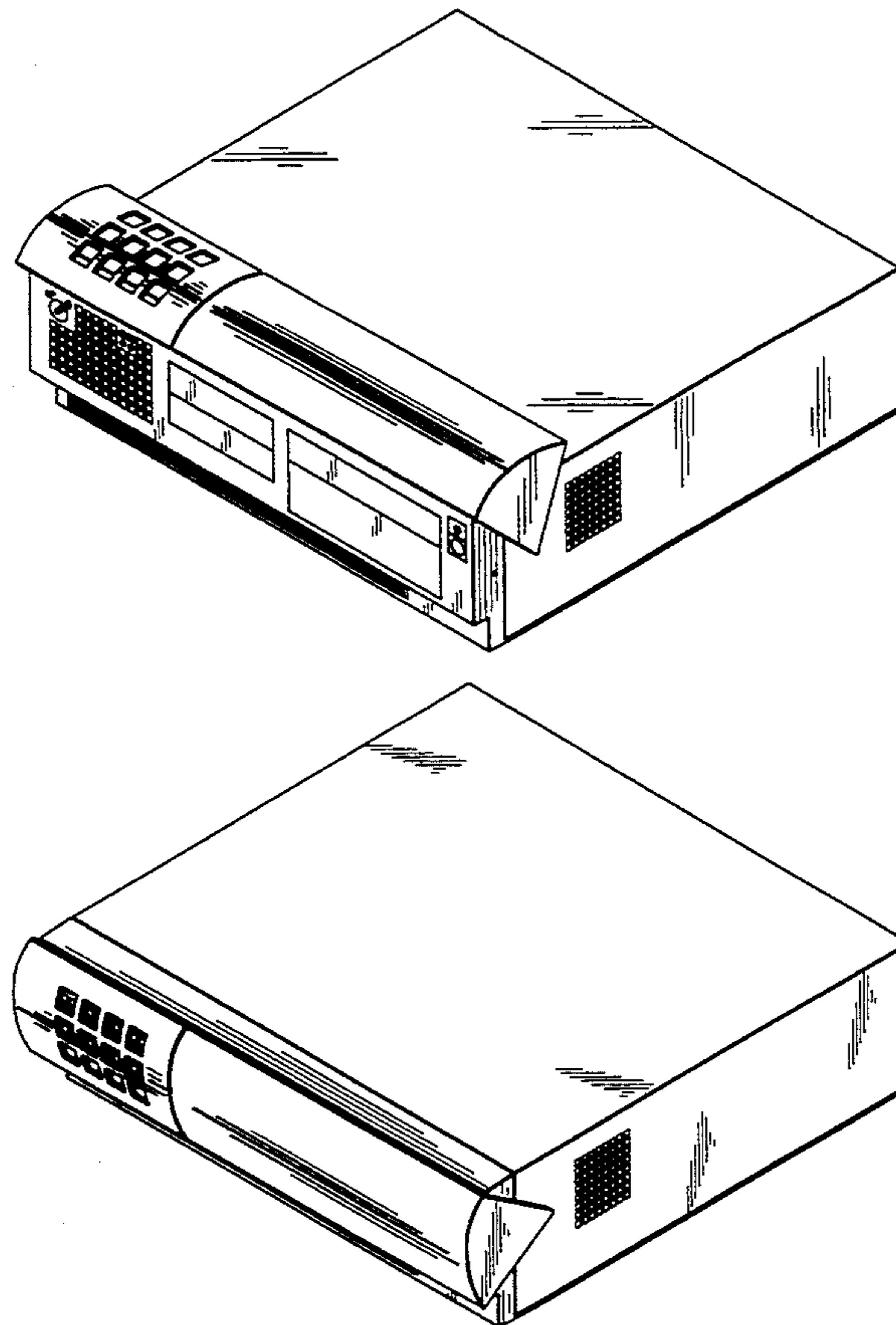

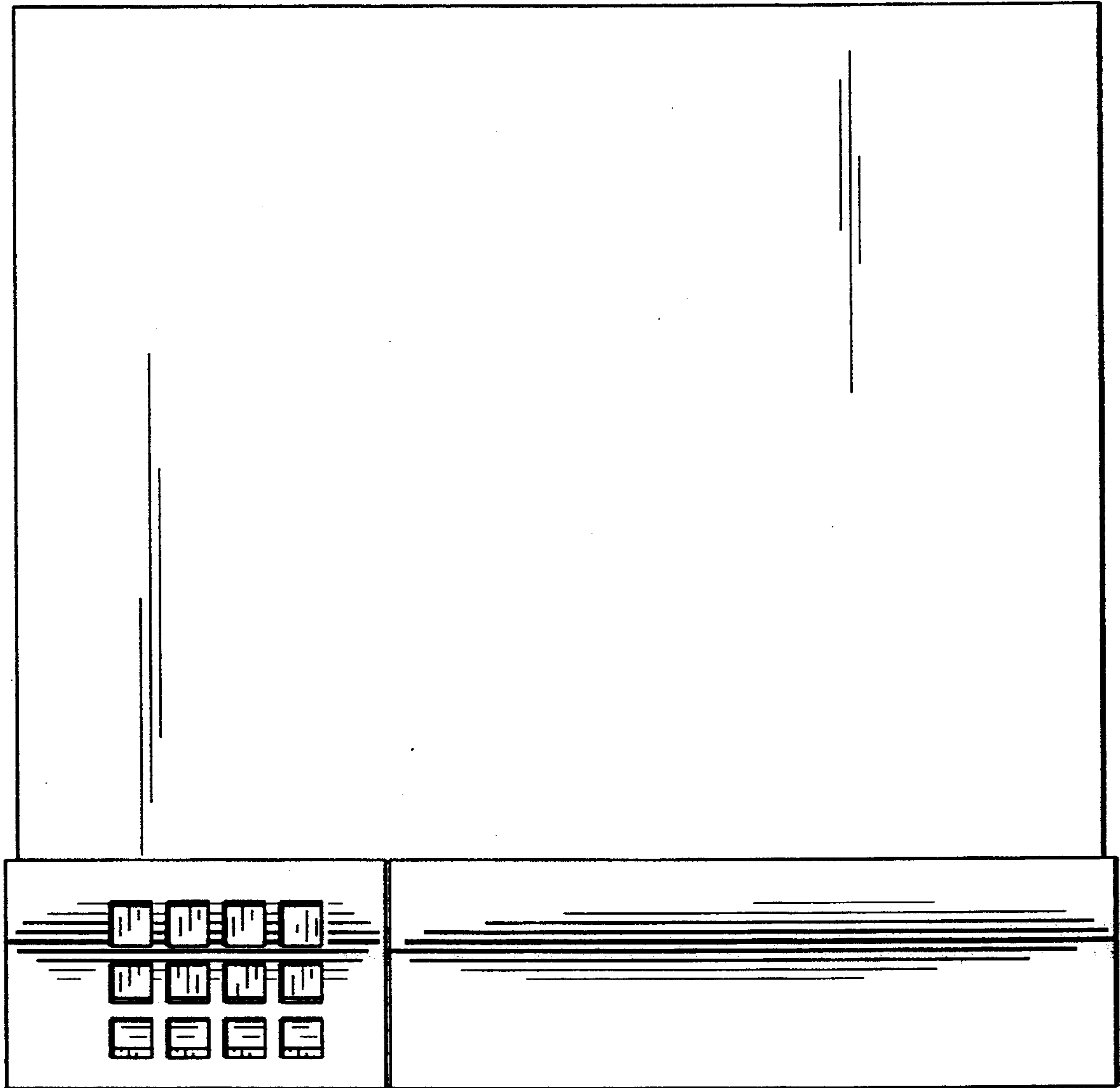

FIG. 1

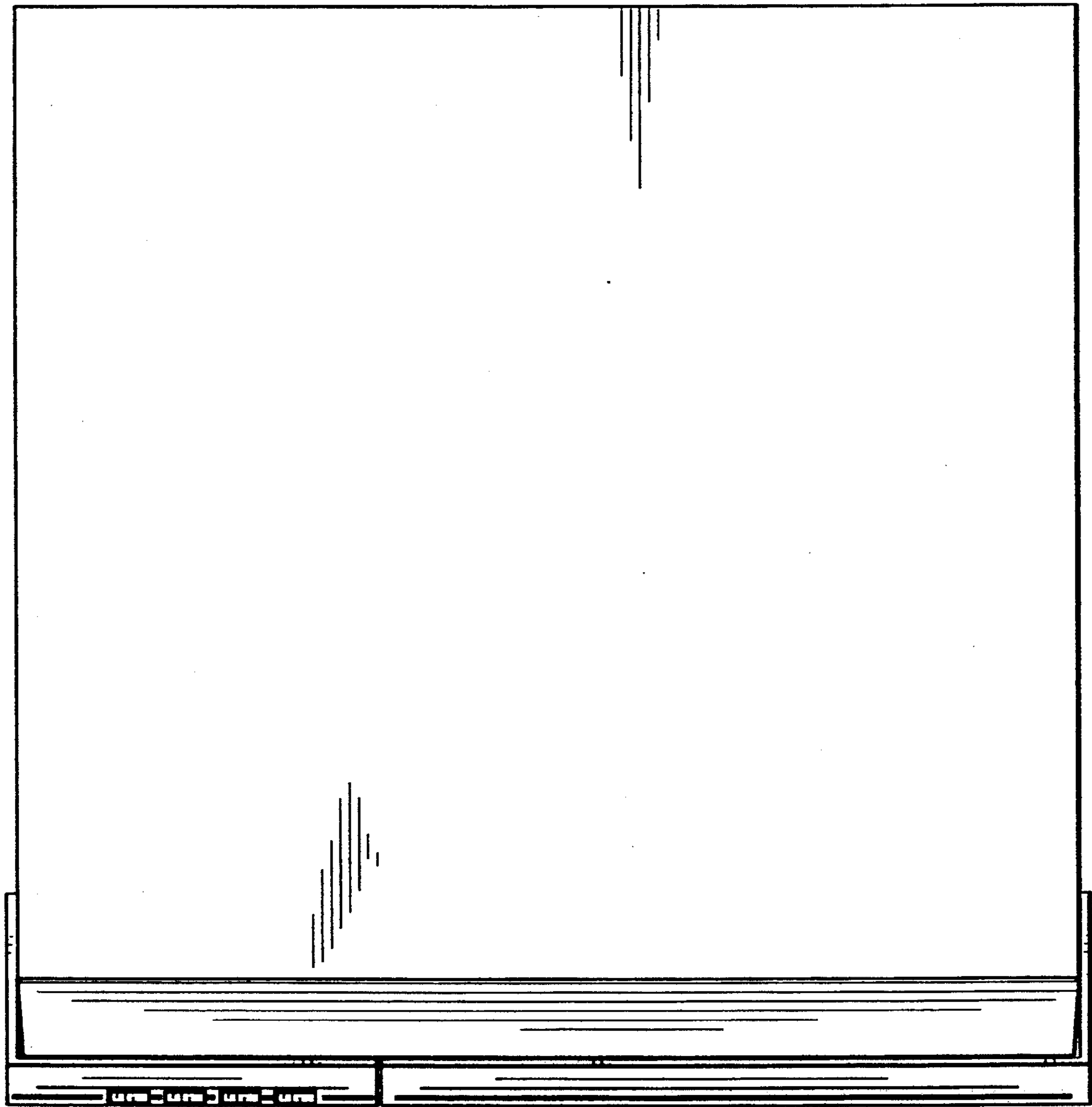

FIG. 2

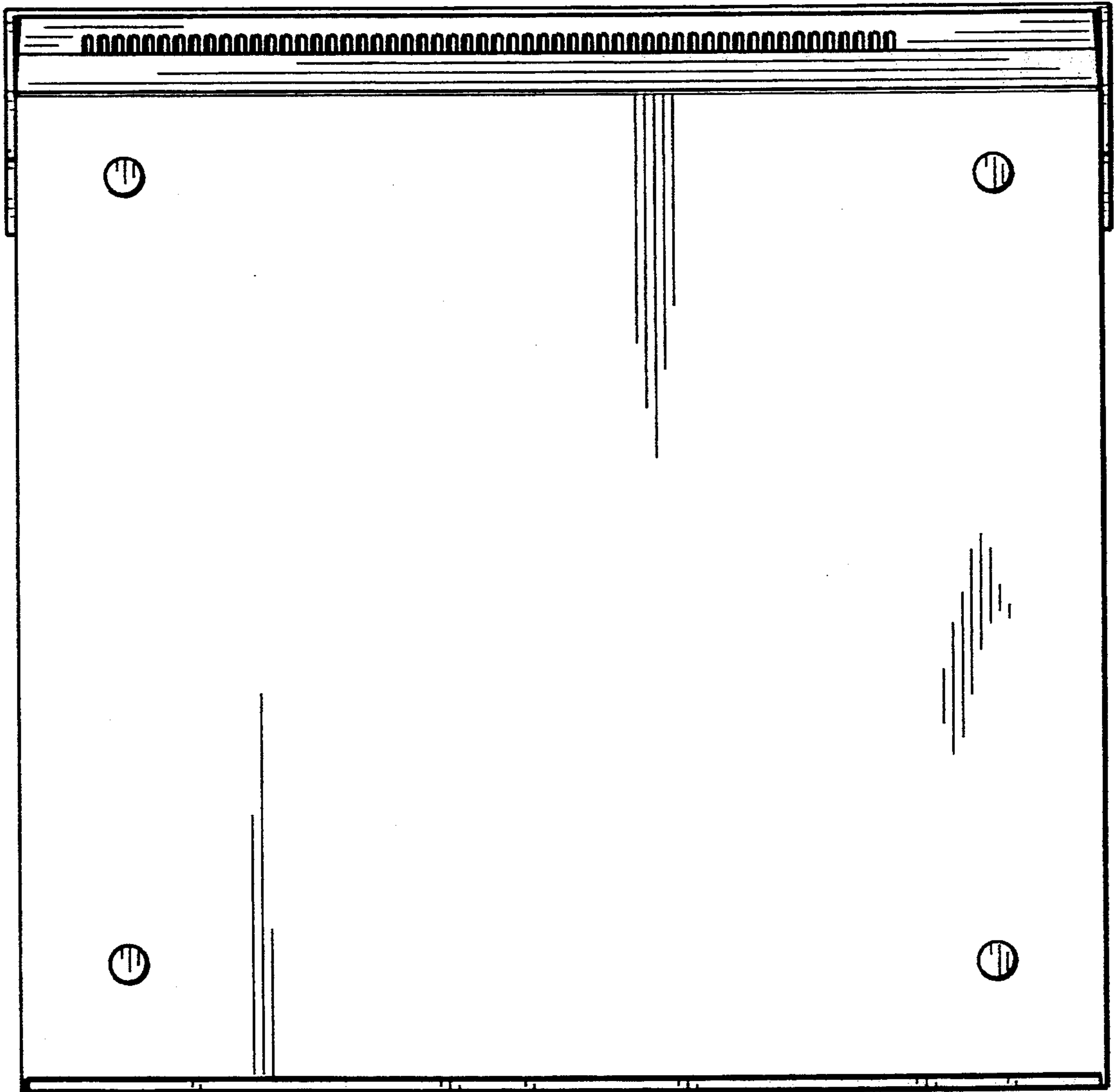

FIG. 3

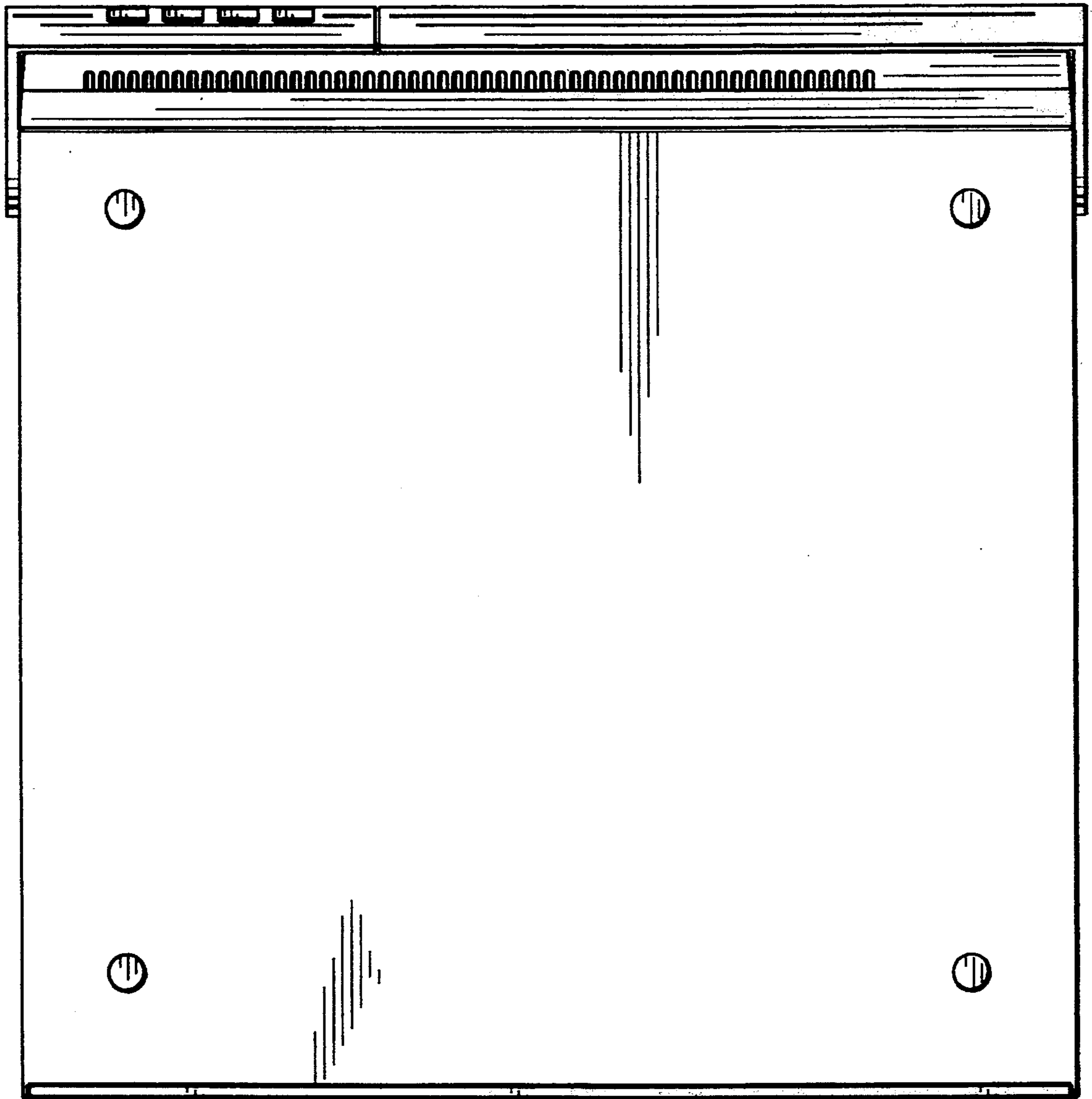

FIG. 4

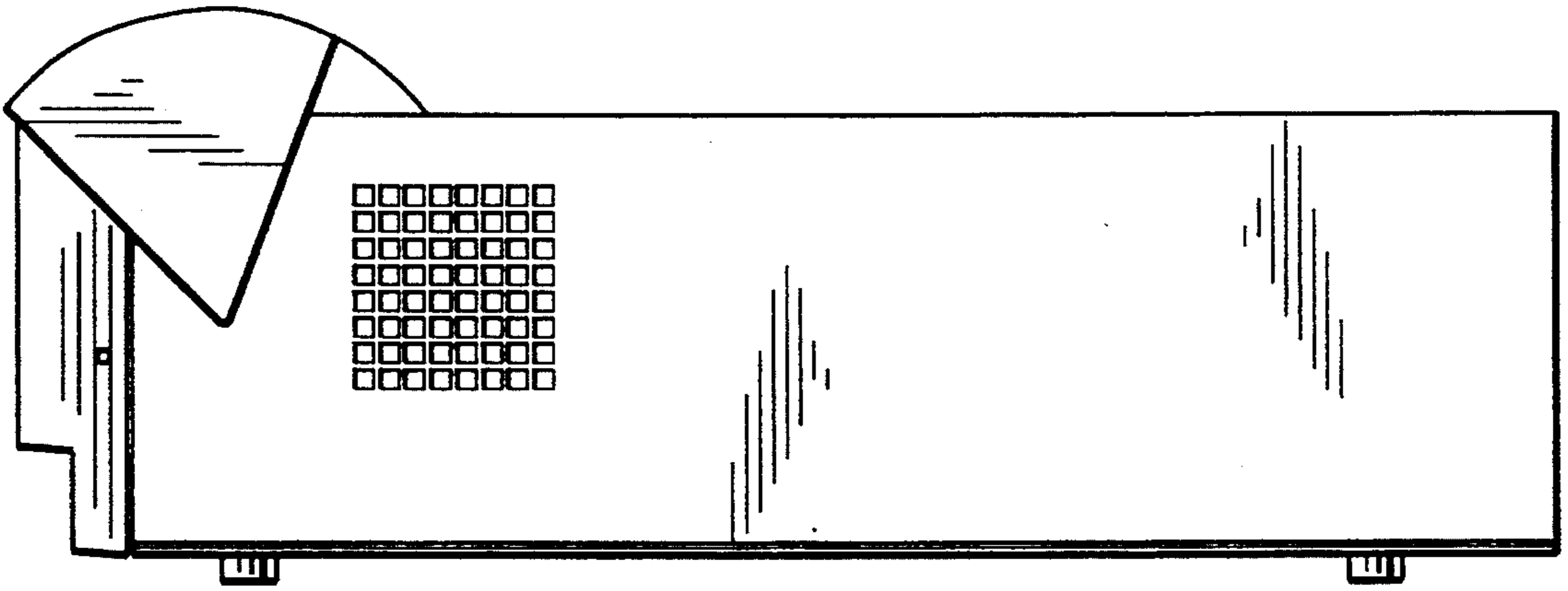

FIG. 5

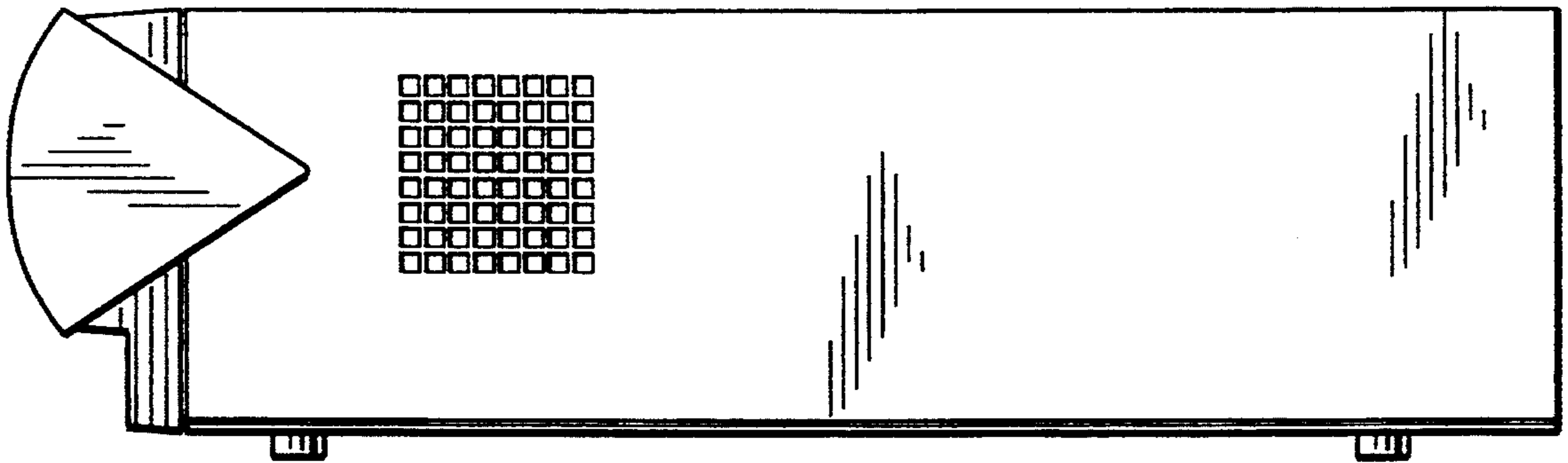

FIG. 6

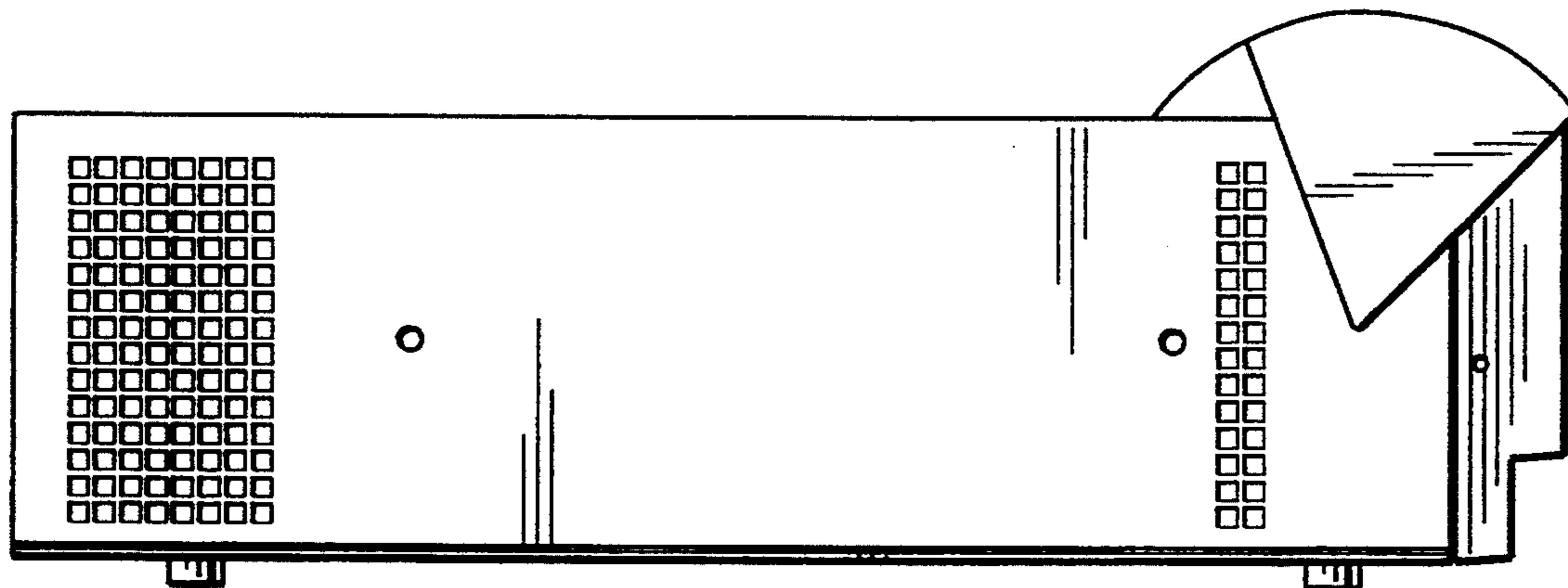

FIG. 7

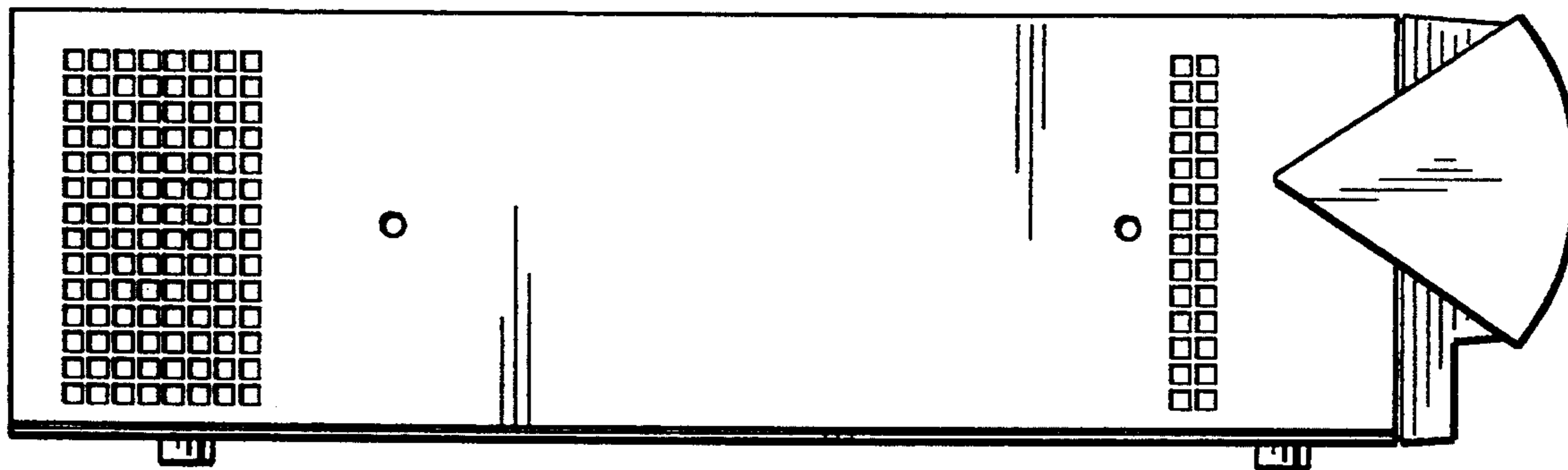

FIG. 8

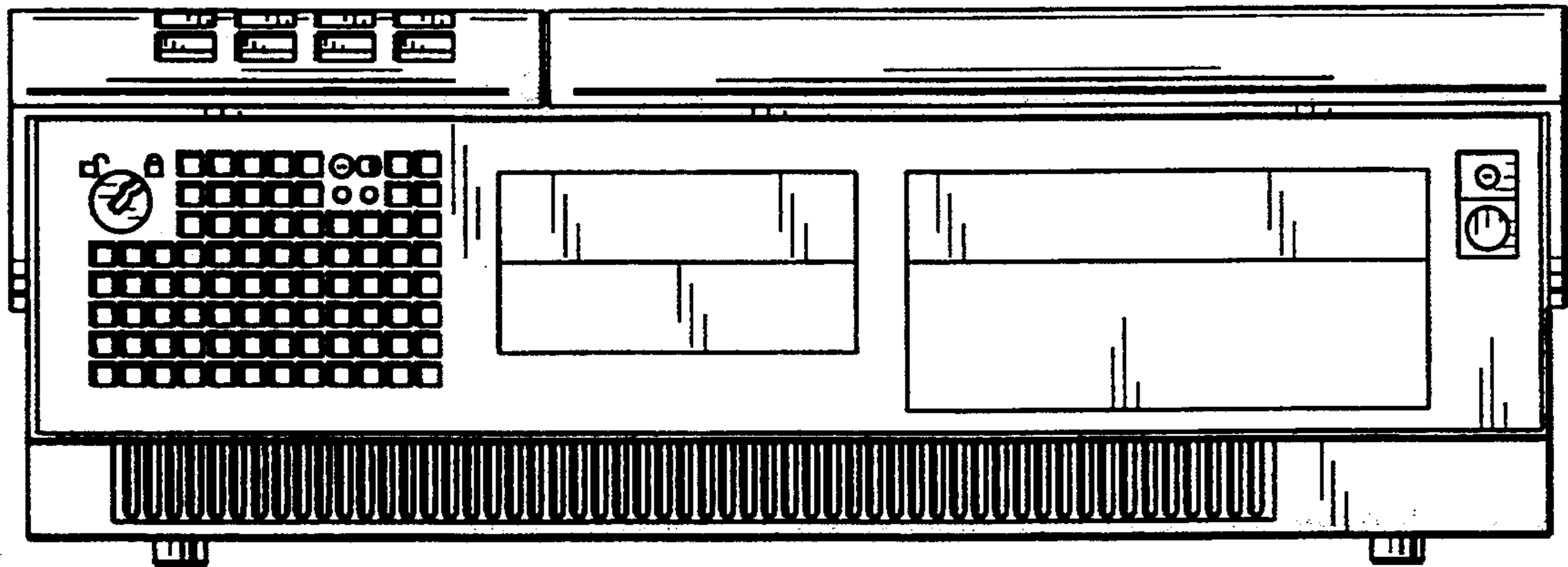

FIG. 9

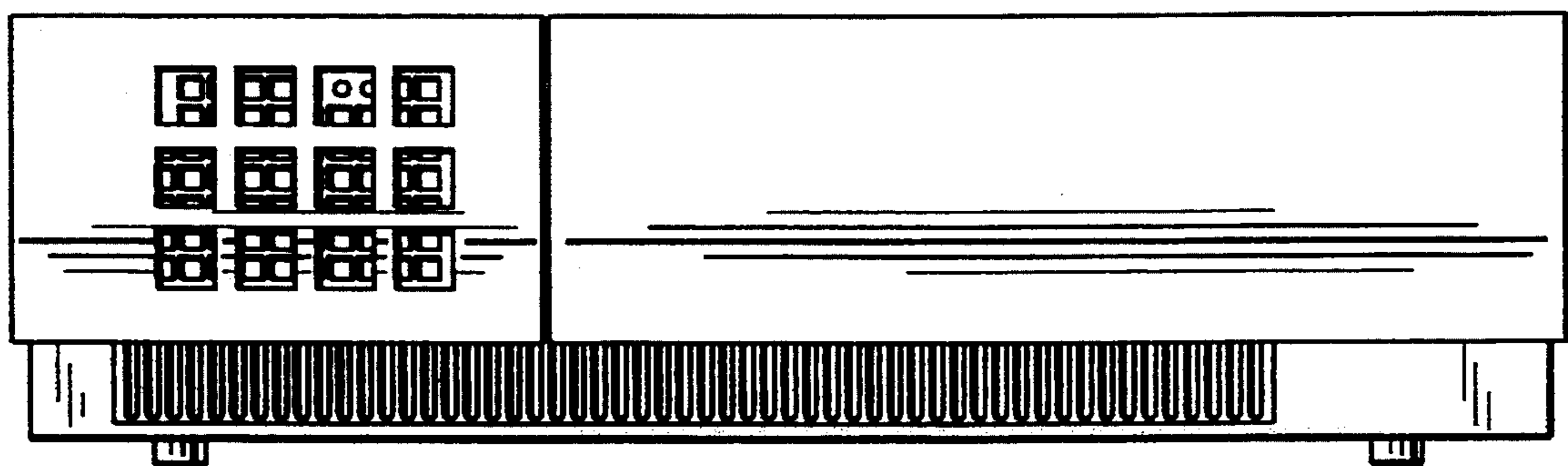

FIG. 10

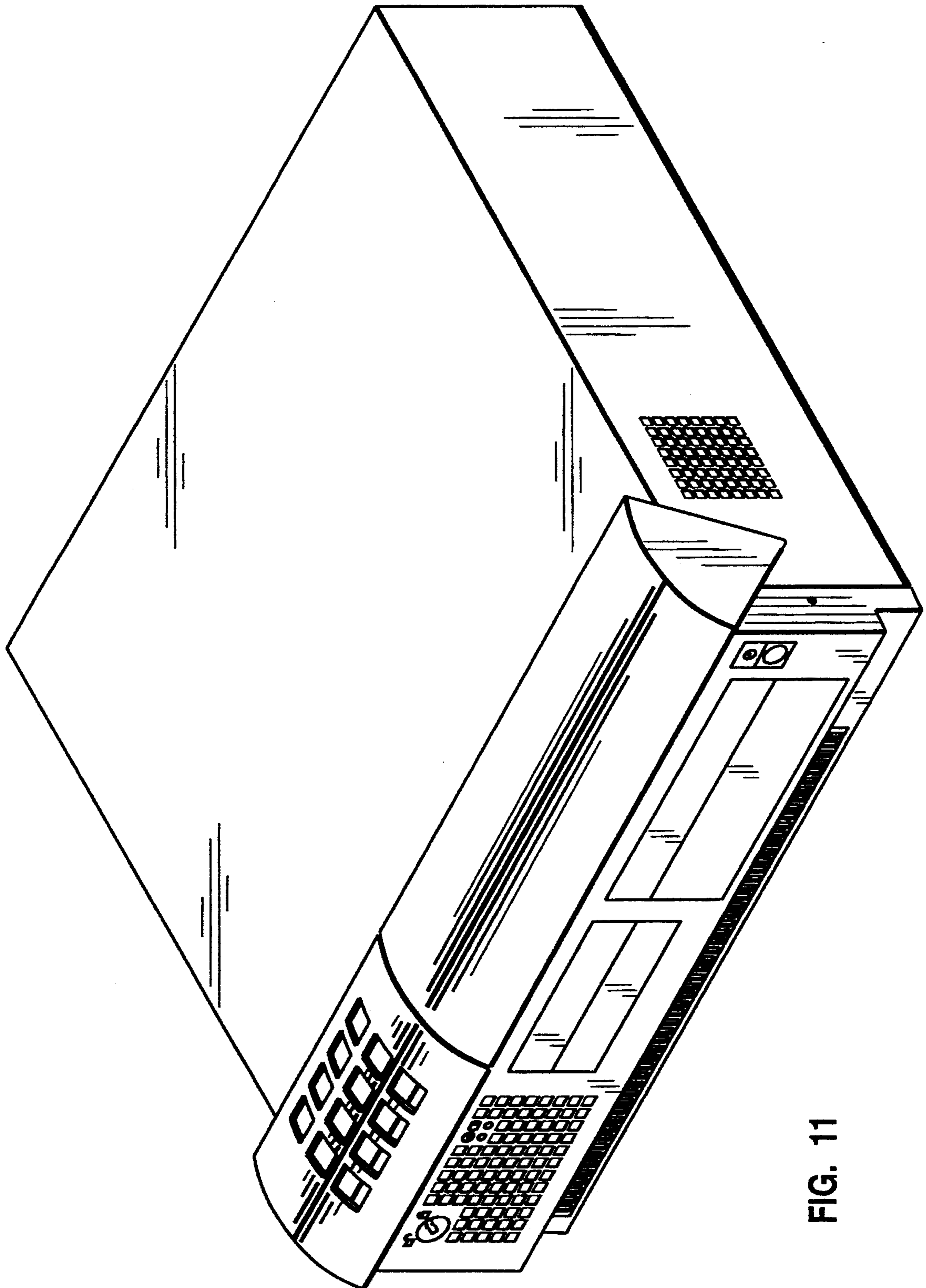

FIG. 11

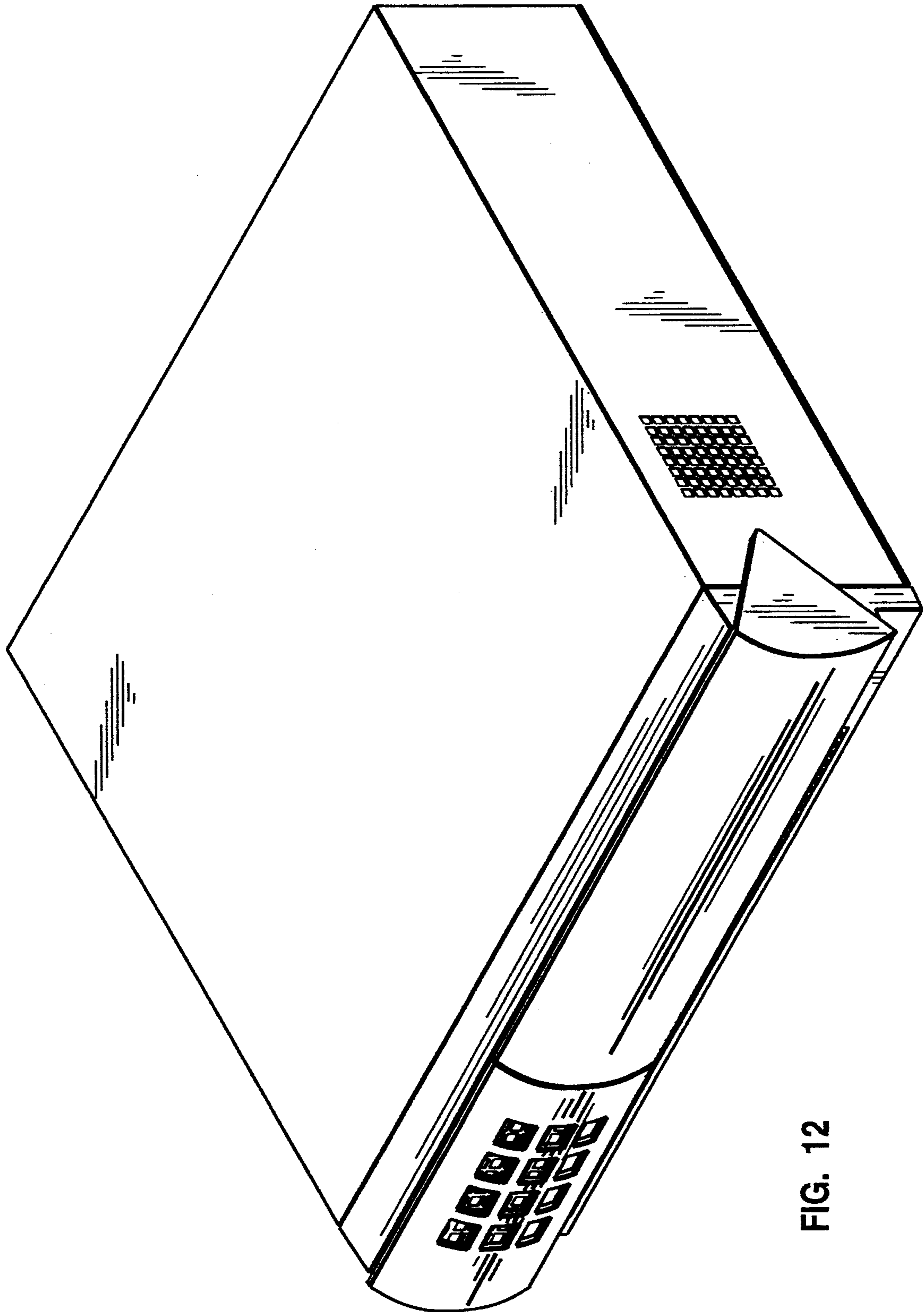

FIG. 12

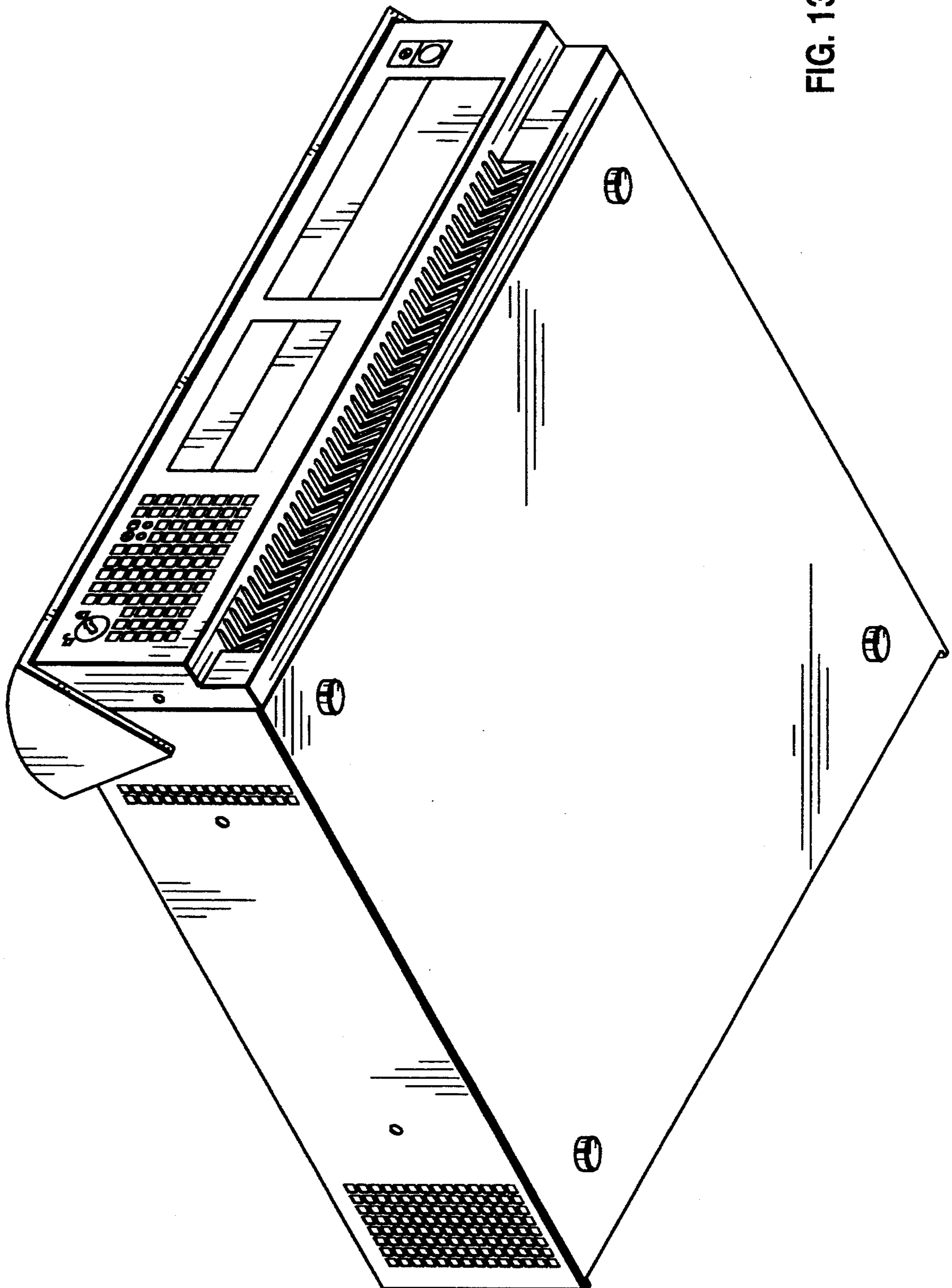

FIG. 13

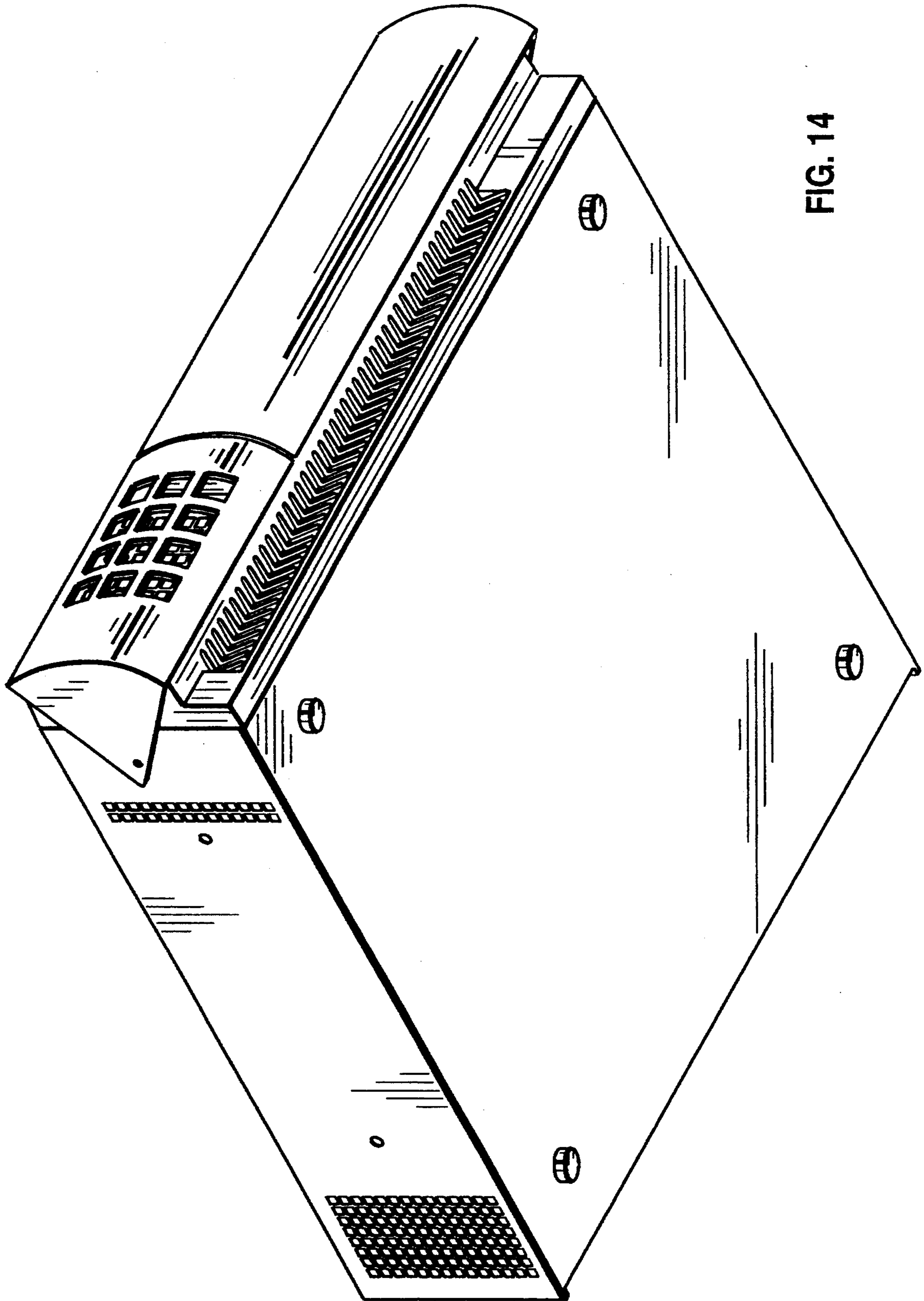

FIG. 14