



US00D356951S

# United States Patent [19]

Mitchell et al.

[11] Patent Number: **Des. 356,951**

[45] Date of Patent: **\*\* Apr. 4, 1995**

## [54] GASOLINE CONTAINER

[75] Inventors: **Robert K. Mitchell**, Brookfield; **John H. Thiermann**, Milwaukee; **Kipp K. Stevens**, Fox Point, all of Wis.

[73] Assignee: **Briggs & Stratton Corporation**, Wauwatosa, Wis.

[\*\*] Term: **14 Years**

[21] Appl. No.: **864,623**

[22] Filed: **Apr. 7, 1992**

### Related U.S. Application Data

[63] Continuation-in-part of Ser. No. 823,564, Jan. 22, 1992, abandoned.

[52] U.S. Cl. .... **D9/527**

[58] Field of Search ..... **D9/502, 516, 518, 447, D9/435, 523, 527; 215/1 R; D23/200, 202; 220/571**

### [56] References Cited

#### U.S. PATENT DOCUMENTS

D. 227,345	6/1973	Bell et al. ....	D9/527
D. 234,042	1/1975	Barton .	
D. 251,772	5/1979	Ernst et al. .	
D. 255,873	7/1980	Hustrei .	
D. 260,614	9/1981	Petersson .....	D9/447
D. 294,061	2/1988	Yokoyama et al. .	
1,331,409	2/1920	Barnett .	
1,617,992	2/1927	Drake .	
2,131,714	9/1938	Woelfer .	
4,632,268	12/1986	Melzi .	
4,928,860	5/1990	Knight .	
5,022,567	6/1991	Frazer .	

## OTHER PUBLICATIONS

Gott Can-Tainers, Mar. 19, 1987.

*Primary Examiner*—Bernard Ansher  
*Assistant Examiner*—Adir Aronovich  
*Attorney, Agent, or Firm*—Andrus, Scales, Starke & Sawall

## [57] CLAIM

The ornamental design for a gasoline container, as shown and described.

## DESCRIPTION

FIG. 1 is a perspective view of a gasoline container showing our new design;

FIG. 2 is a front elevation view of the container of FIG. 1;

FIG. 3 is a rear elevation view of the container of FIG. 1;

FIG. 4 is a top plan view of the container of FIG. 1;

FIG. 5 is a right side elevation view of the container of FIG. 1, the undisclosed left side being a mirror image thereof;

FIG. 6 is a bottom plan view of the container of FIG. 1;

FIG. 7 is a right side elevation view of a second embodiment, the undisclosed views being identical to the corresponding views disclosed in the first embodiment;

FIG. 8 is a perspective view of a third embodiment with its nozzle omitted for ease of illustration;

FIG. 9 is a front elevation view of the container of FIG. 8;

FIG. 10 is a rear elevation view of the container of FIG. 8;

FIG. 11 is a top plan view of the container of FIG. 8;

FIG. 12 is a right side elevation view of the container of FIG. 8, the undisclosed left side being a mirror image thereof; and,

FIG. 13 is a bottom plan view of the container of FIG. 8.

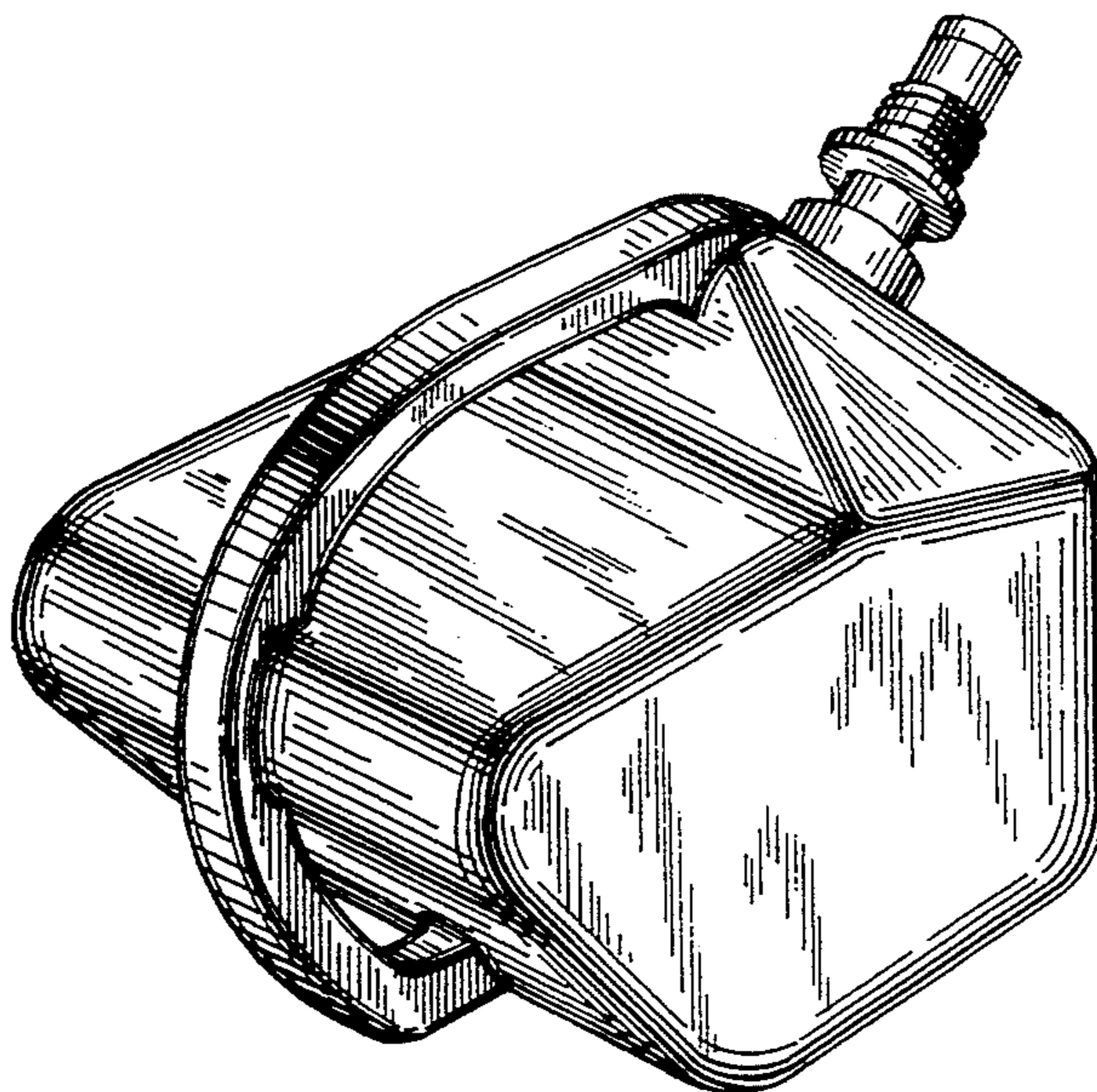

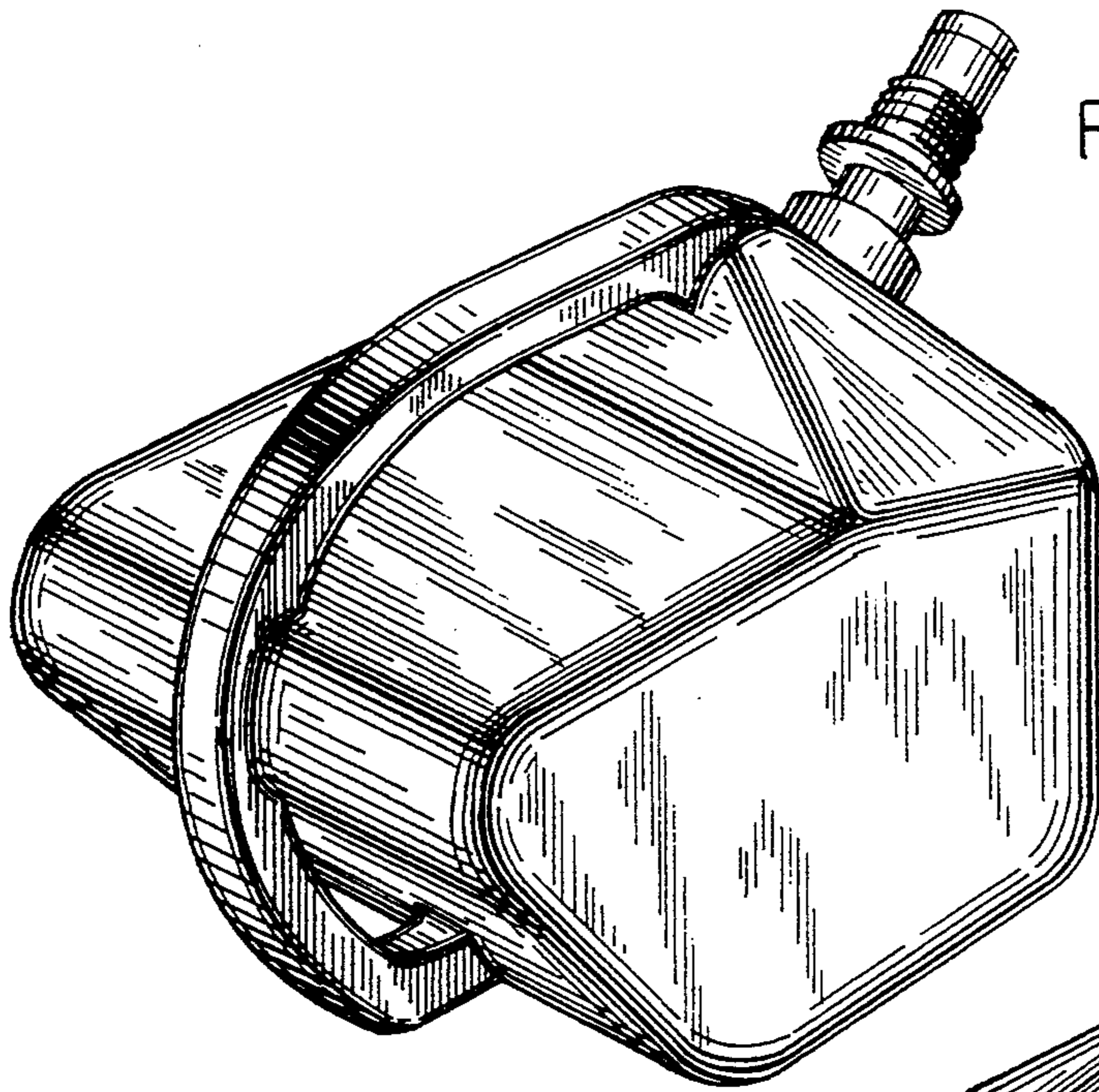

FIG. 1

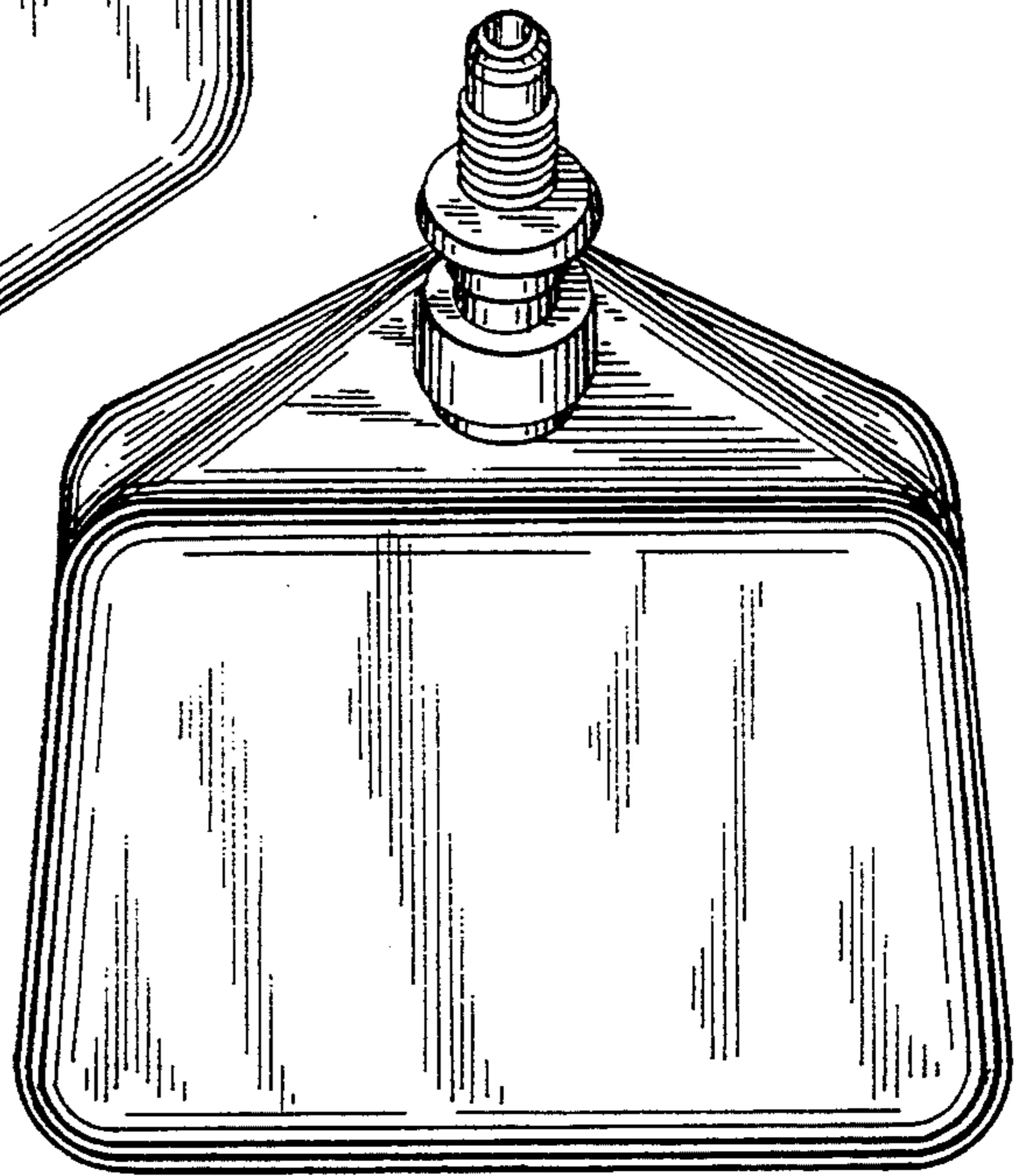

FIG. 2

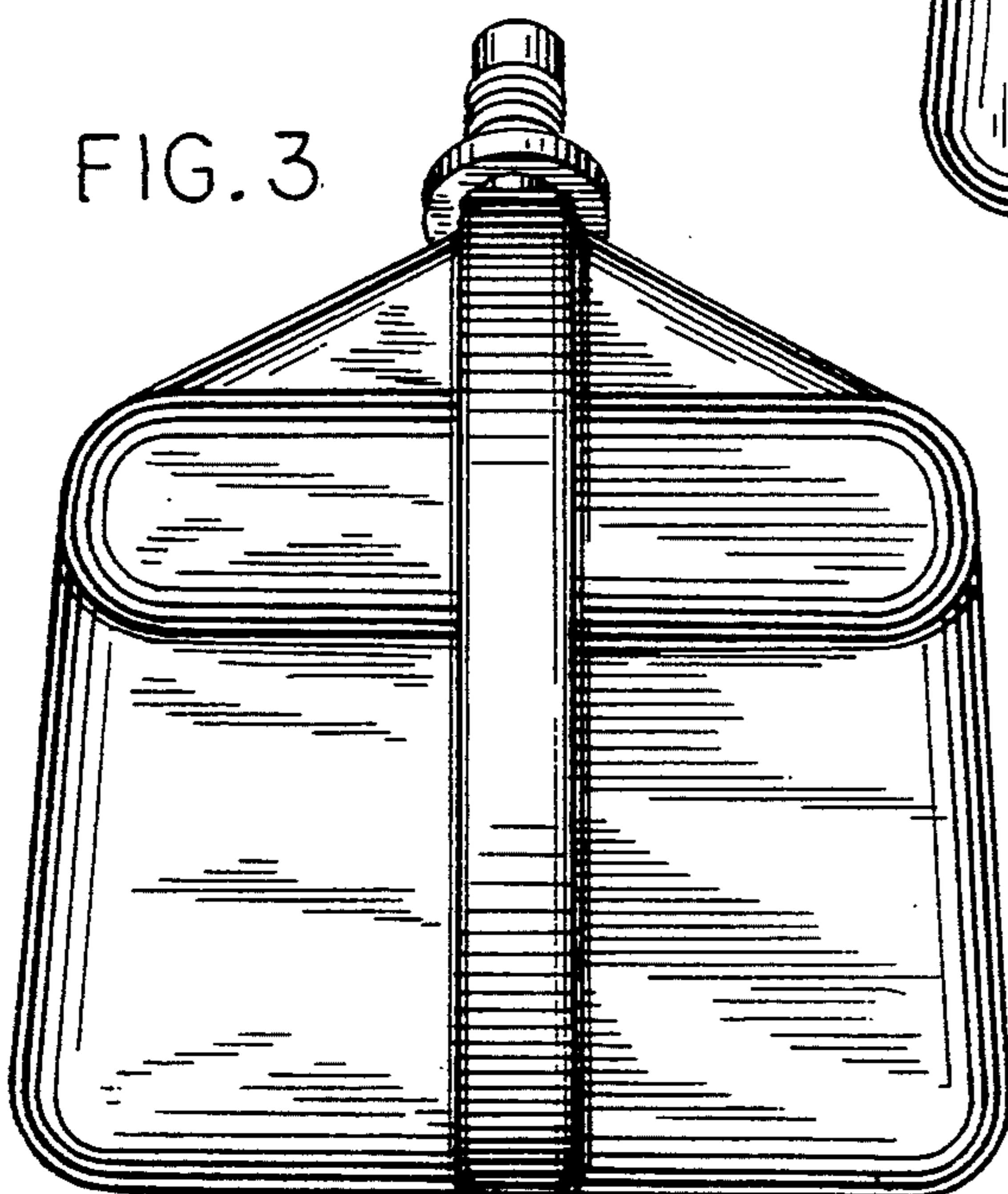

FIG. 3



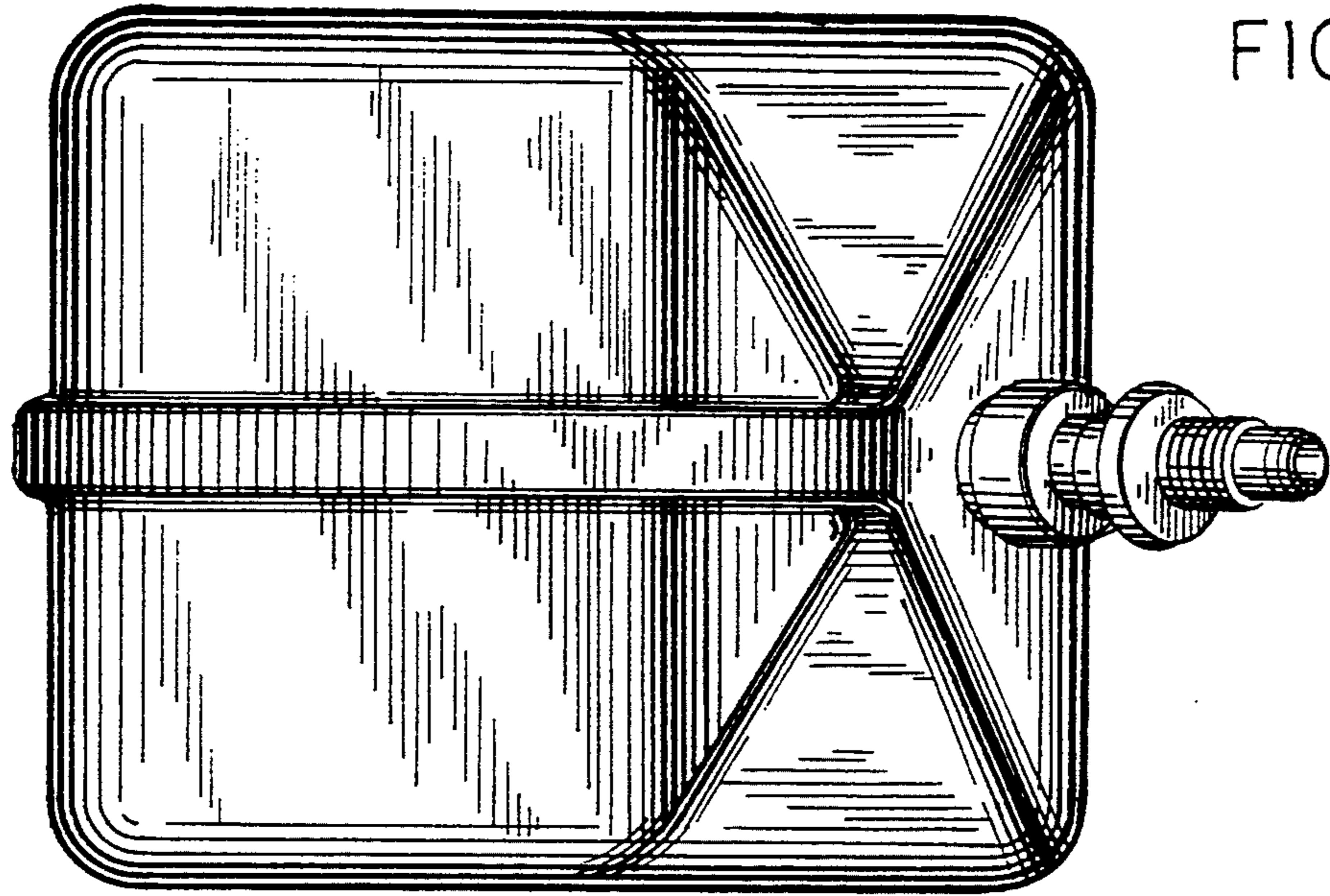

FIG. 4

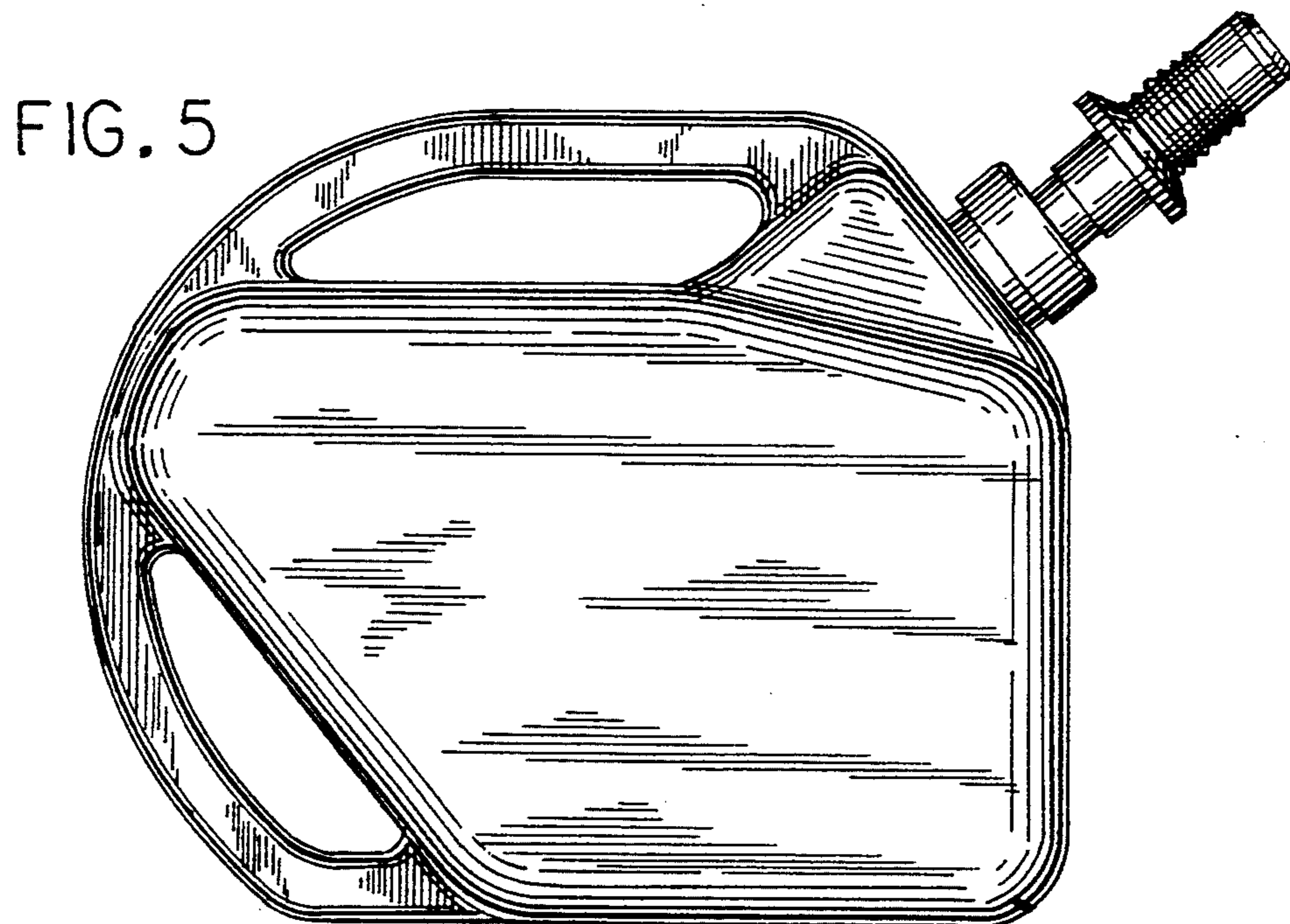

FIG. 5

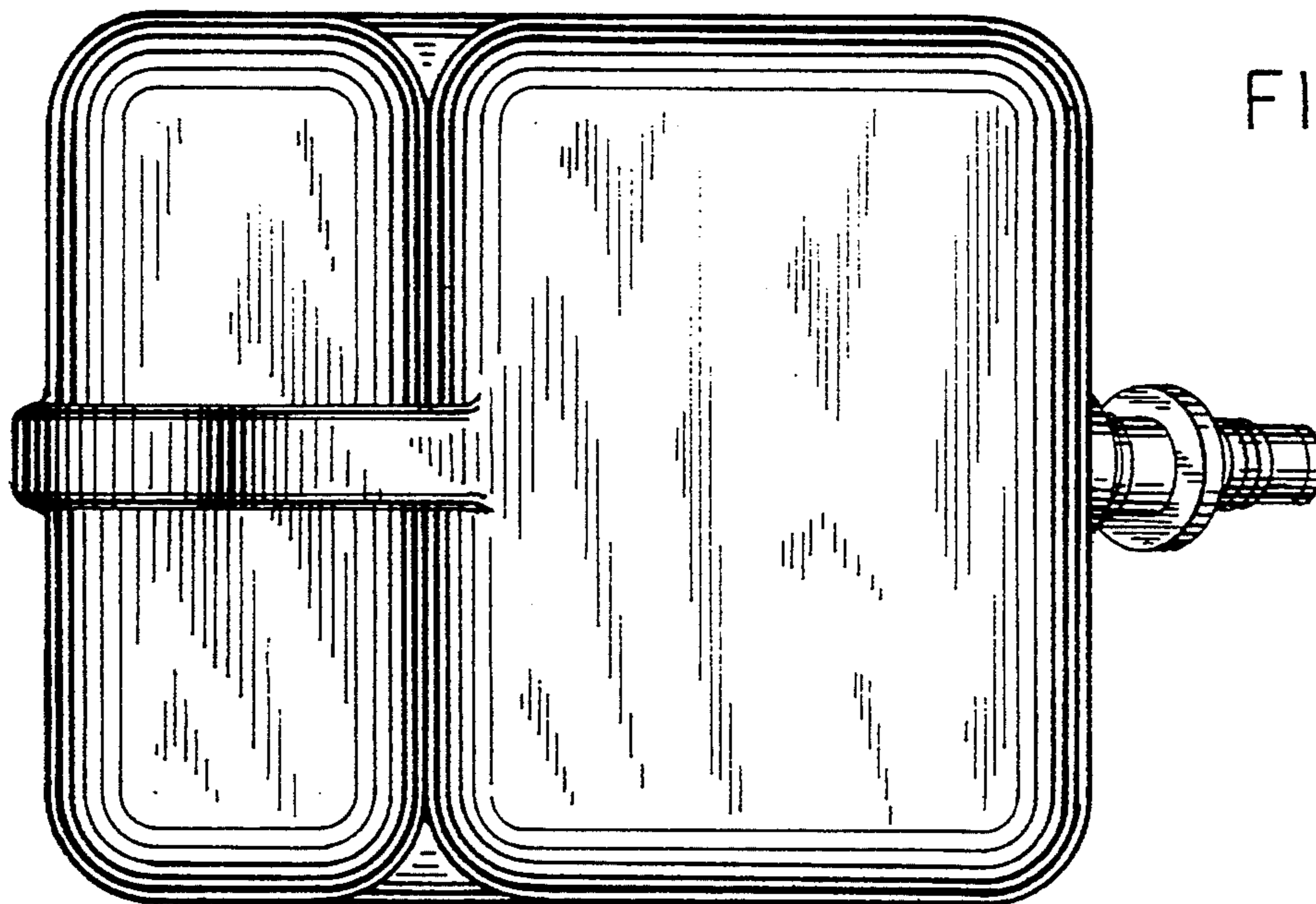

FIG. 6

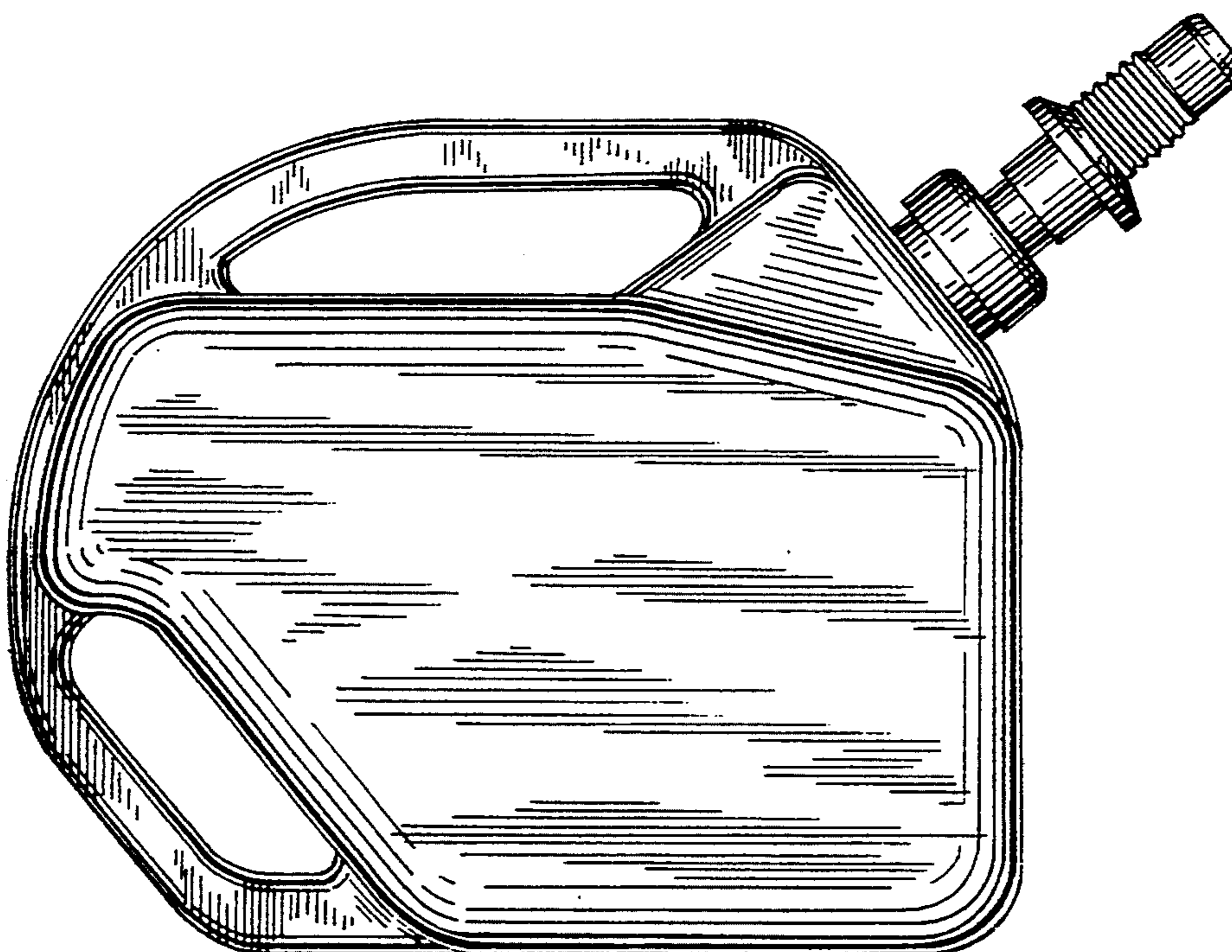

FIG. 7



FIG. 8

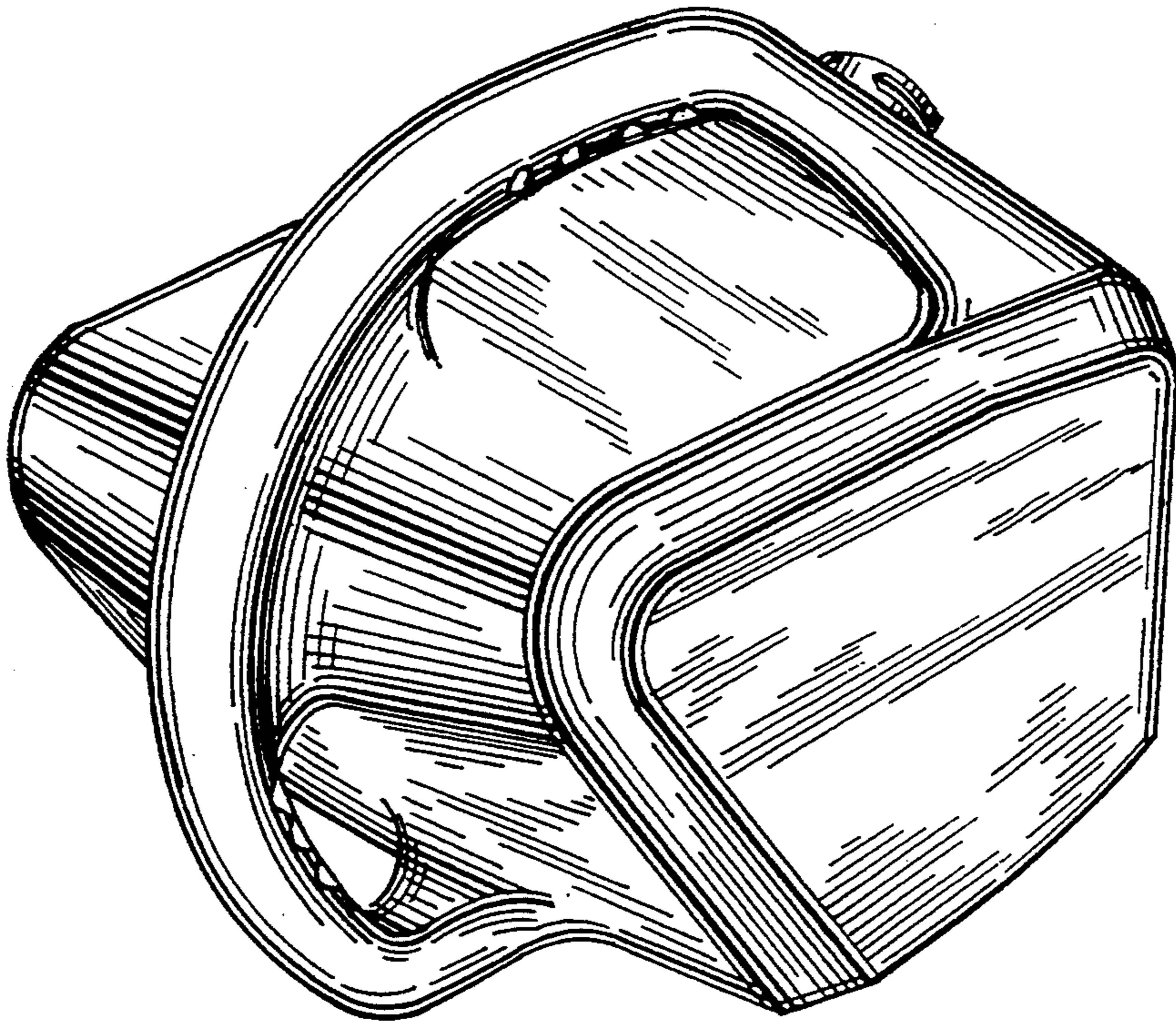

FIG. 9

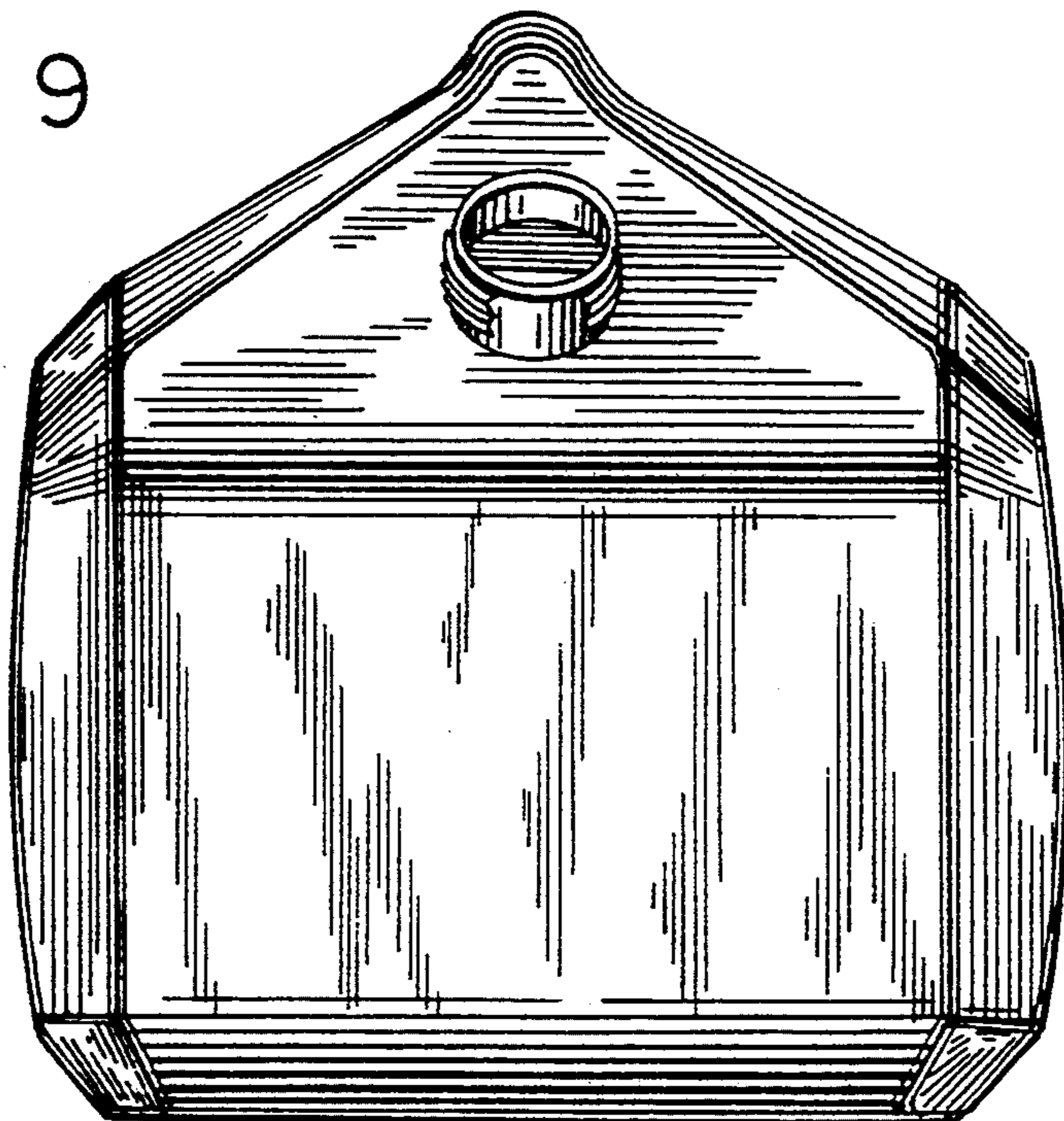

FIG. 10

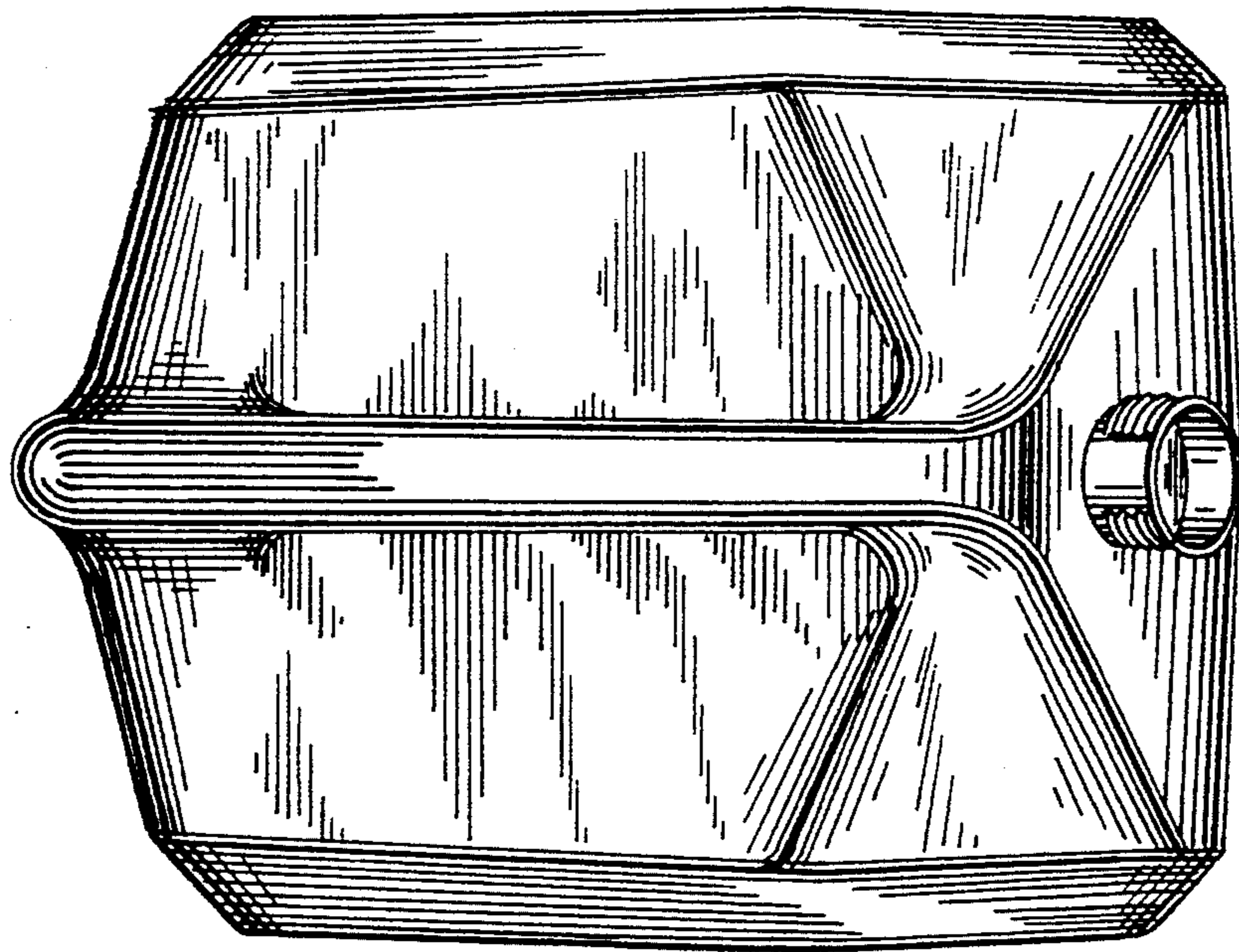
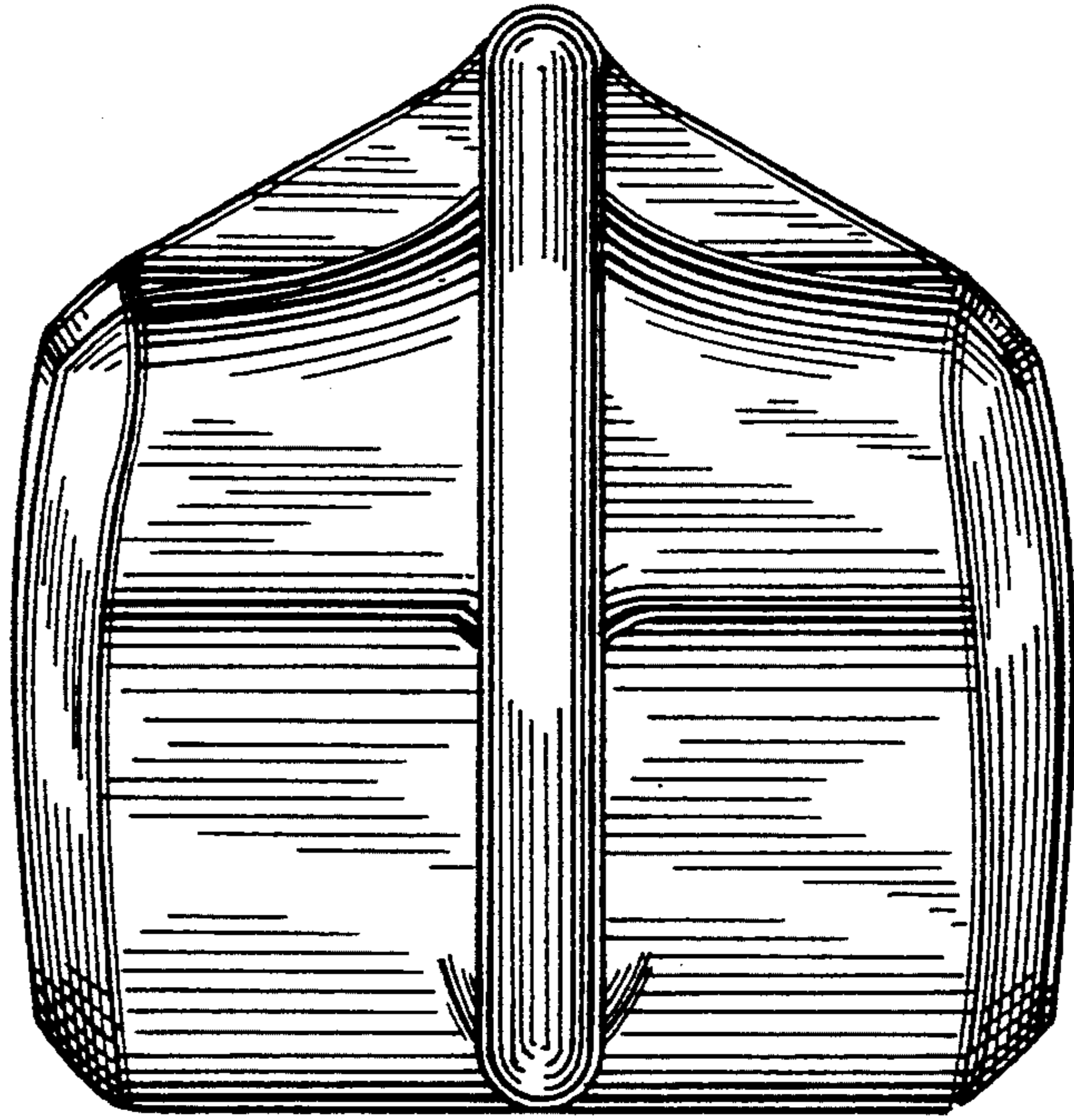

FIG. 11



FIG. 12

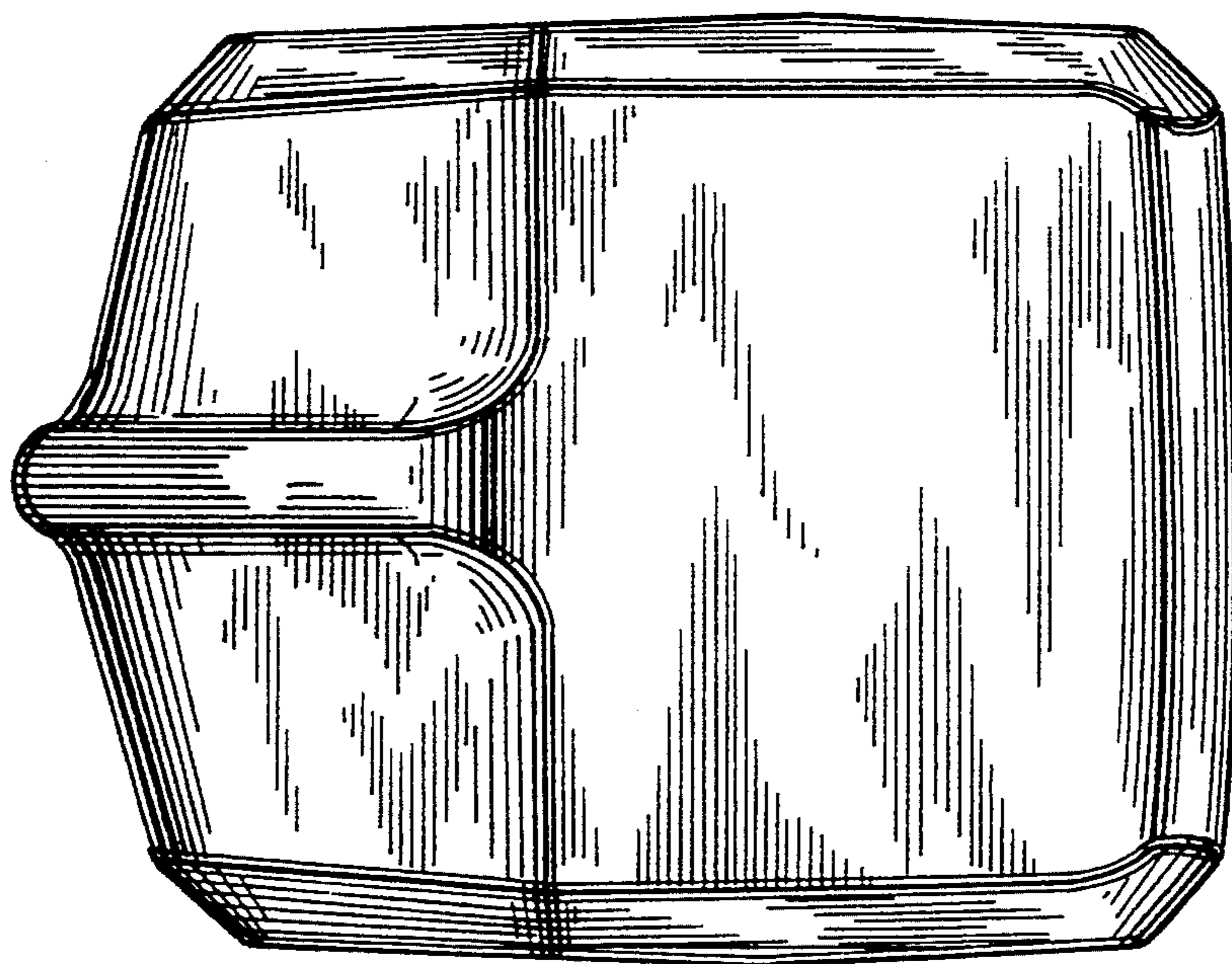
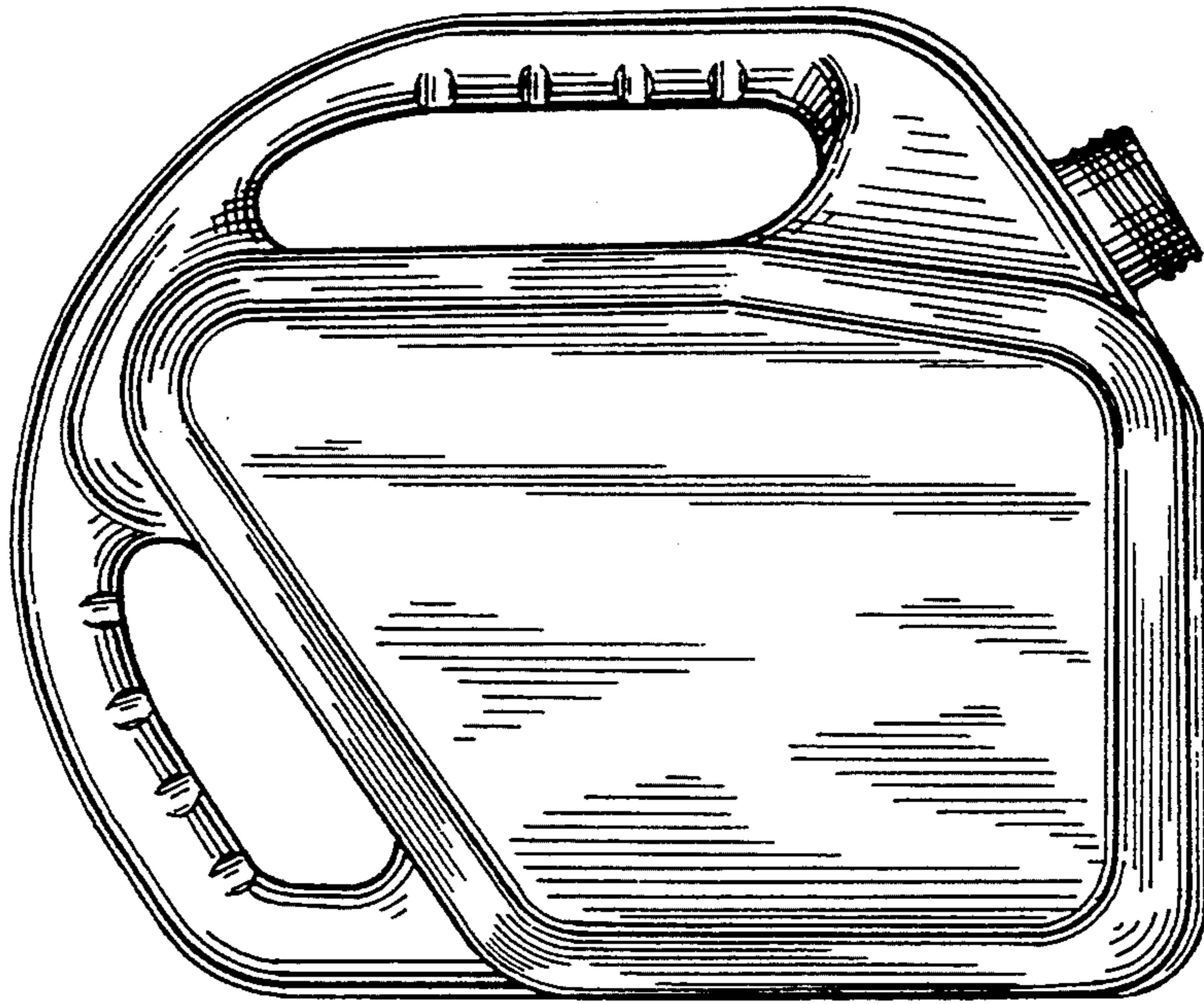

FIG. 13