



US00D356950S

United States Patent [19]

[11] Patent Number: **Des. 356,950**

Apps et al.

[45] Date of Patent: **** Apr. 4, 1995**

[54] **DIVIDER FOR BOTTLES**

[75] Inventors: **William P. Apps, Anaheim; Gerald R. Koefeld, Seal Beach, both of Calif.; Larry E. Shermer, Atlanta, Ga.**

[73] Assignees: **Rehrig Pacific Company, Inc., Los Angeles, Calif.; The Coca-Cola Company, Atlanta, Ga.**

[**] Term: **14 Years**

[21] Appl. No.: **1,590**

[22] Filed: **Nov. 19, 1992**

[52] U.S. Cl. **D9/456**

[58] Field of Search **D9/344, 434, 456, 499; D34/45, 46; D7/616; 206/159-160, 593; 215/101; 220/553-554**

3,998,328	12/1976	Box .
4,093,101	6/1978	Braun .
4,190,172	2/1980	Box .
4,468,067	8/1984	Jenkins .
4,538,742	9/1985	Prodel .
4,846,365	7/1989	Steinlein .
4,884,712	12/1989	Schoeller et al. .
5,044,921	9/1991	Micelli et al. .
5,071,026	12/1991	Apps .
5,097,980	3/1992	Warwick .

FOREIGN PATENT DOCUMENTS

636543	12/1963	Belgium .
458070	7/1949	Canada .
0201968	5/1986	European Pat. Off. .
2361282	4/1978	France .
2-45357	2/1990	Japan .
3-111255	5/1991	Japan .
1604094	12/1981	United Kingdom .

[56] **References Cited**

U.S. PATENT DOCUMENTS

D. 197,356	1/1964	DeShazor, Jr.	D9/344
D. 197,357	1/1964	DeShazor, Jr.	206/159 X
D. 197,358	1/1964	DeShazor, Jr.	206/159 X
D. 212,075	8/1968	Perlman	D9/344
D. 331,698	12/1992	Pezzoli et al.	D9/455
732,245	6/1903	Weiss .	
2,583,224	1/1952	McDonald .	
2,886,202	5/1959	Waller .	
2,888,164	5/1959	Corwin	206/160
2,964,210	12/1960	Paley .	
3,126,599	3/1964	Holland	206/159
3,153,294	10/1964	Hey et al. .	
3,240,378	3/1966	Fox .	
3,245,573	4/1966	Bakos .	
3,286,833	11/1966	Chadourni	206/160
3,297,190	1/1967	Cloyd .	
3,327,885	6/1967	Carle et al. .	
3,353,704	11/1967	Belcher et al. .	
3,368,709	2/1968	Waller .	
3,370,700	2/1968	DeShazor, Jr.	206/159
3,410,398	11/1968	Arneson	206/159
3,568,879	3/1971	Box .	
3,656,650	4/1972	Frater .	
3,752,385	8/1973	Woodgate .	
3,773,206	11/1973	Garcia .	

Primary Examiner—Alan P. Douglas
Assistant Examiner—R. Spear
Attorney, Agent, or Firm—Banner, Birch, McKie & Beckett

[57] **CLAIM**

The ornamental design for a divider for bottles, as shown and described.

DESCRIPTION

FIG. 1 is a top plan view of a divider for bottles showing our new design;
 FIG. 2 is a bottom plan view thereof;
 FIG. 3 is a front elevational view thereof the rear elevational view being a mirror image thereof;
 FIG. 4 is a right side elevational view thereof;
 FIG. 5 is a cross sectional view taken along line 5—5 of FIG. 1;
 FIG. 6 is a partial cross-sectional view taken on line 6—6 of FIG. 1;
 FIG. 7 is a partial cross-sectional view taken on line 7—7 of FIG. 1;
 FIG. 8 is an enlarged cross-sectional view taken on line 8—8 of FIG. 1 and,
 FIG. 9 is a left side elevational view thereof.

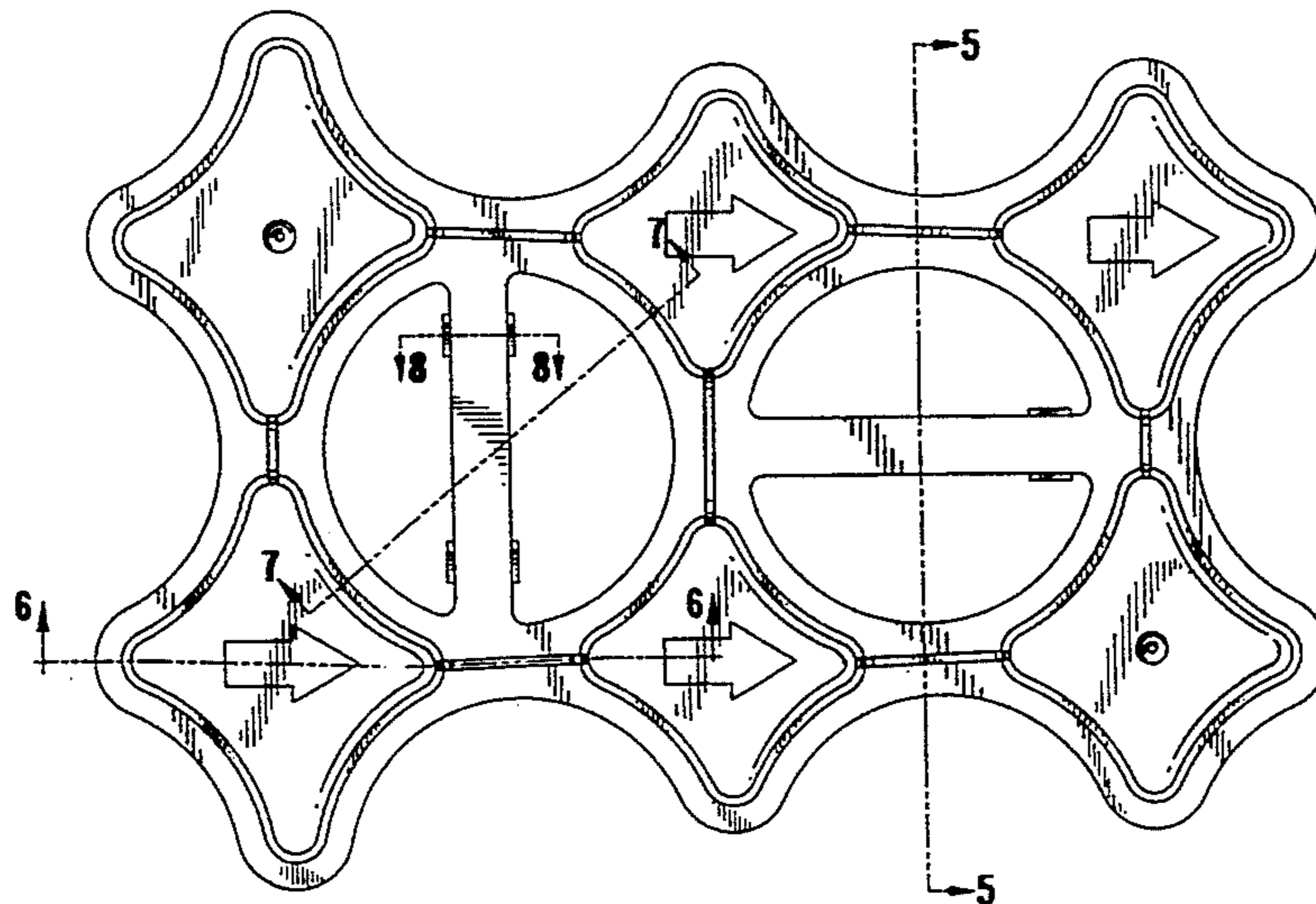

FIG. 1

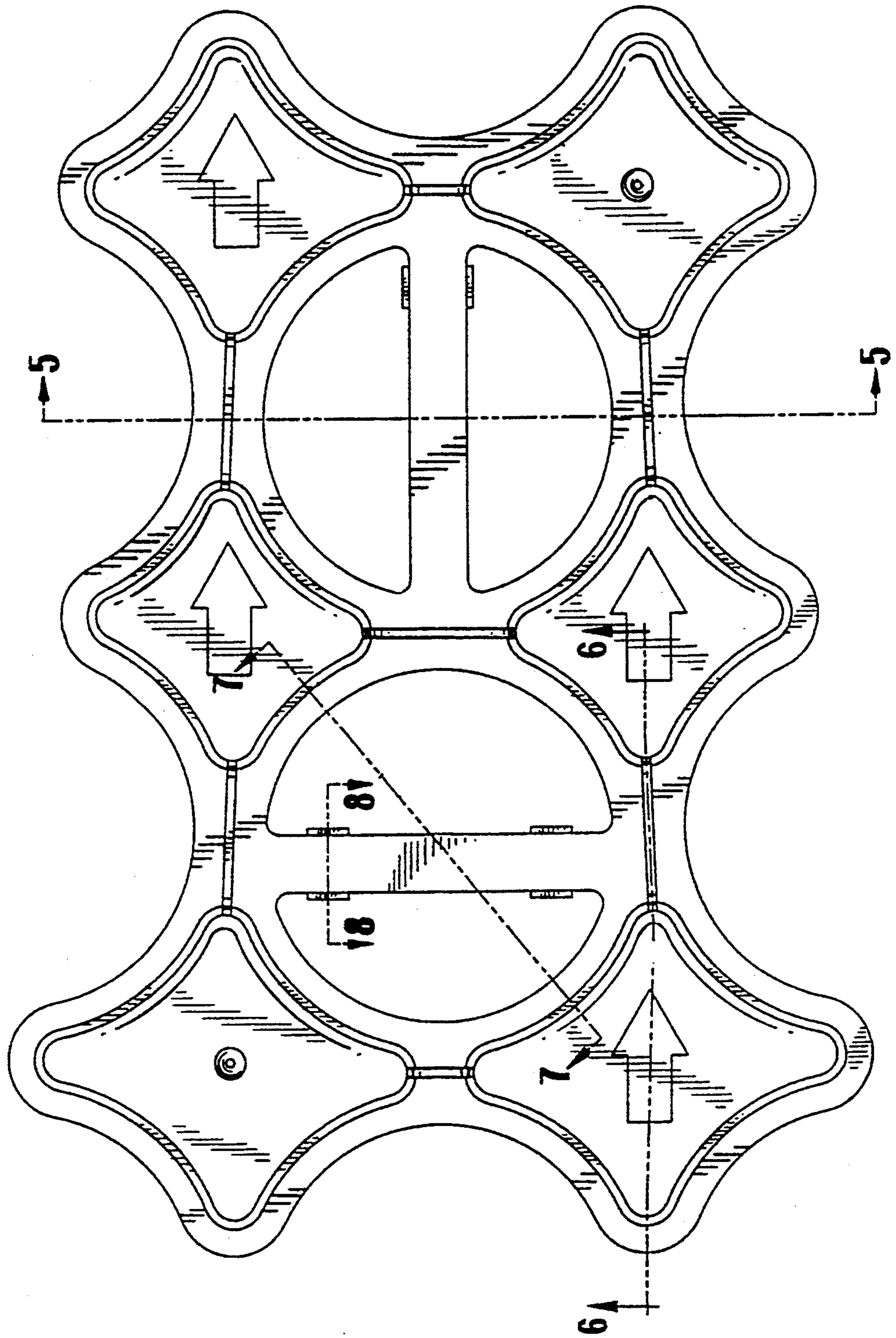

FIG. 2

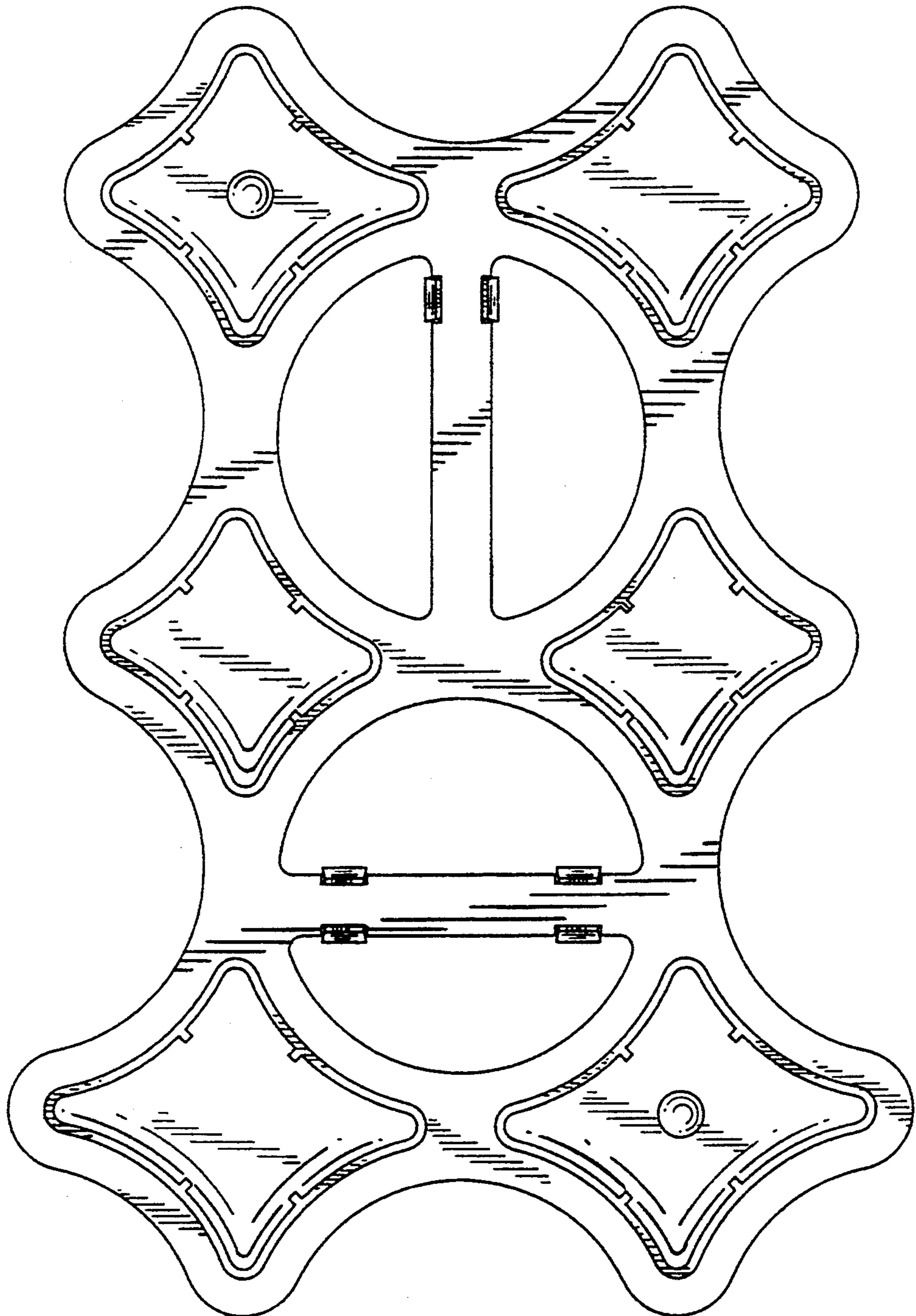

FIG. 3

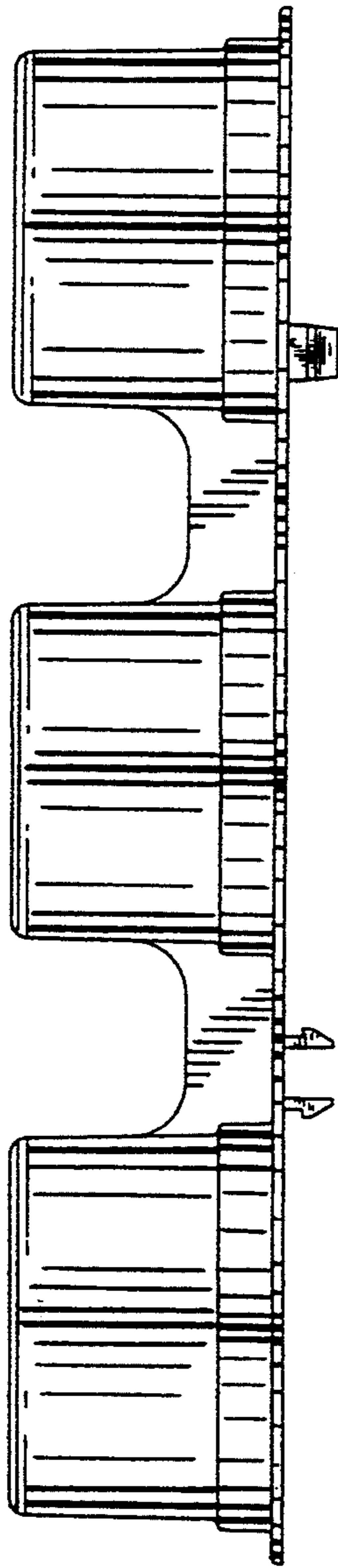

FIG. 4

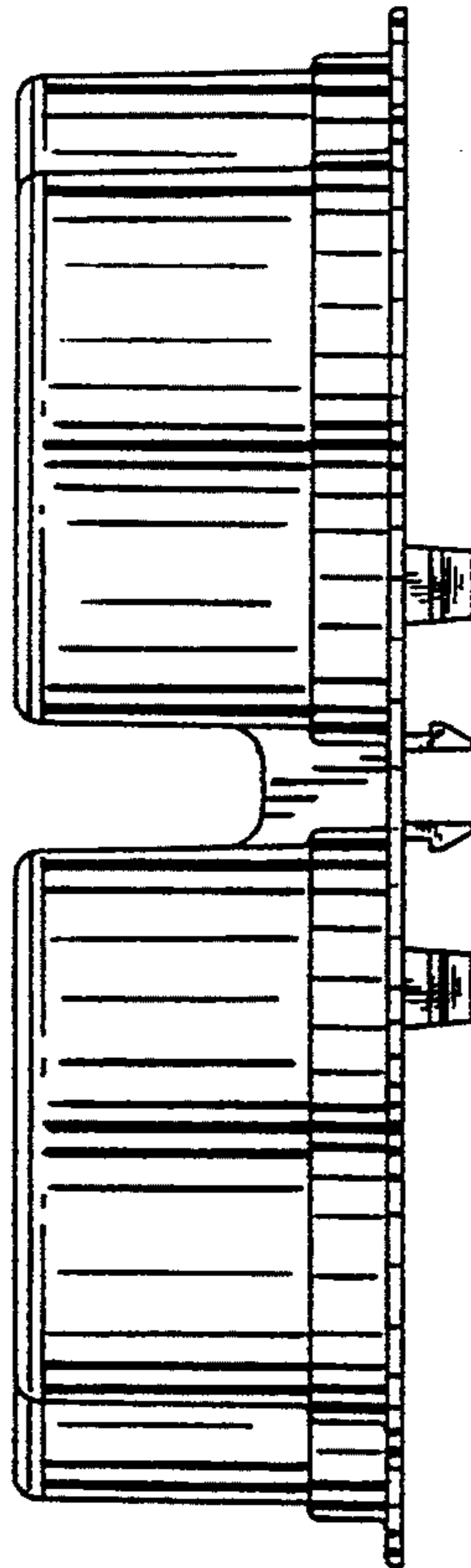

FIG. 6

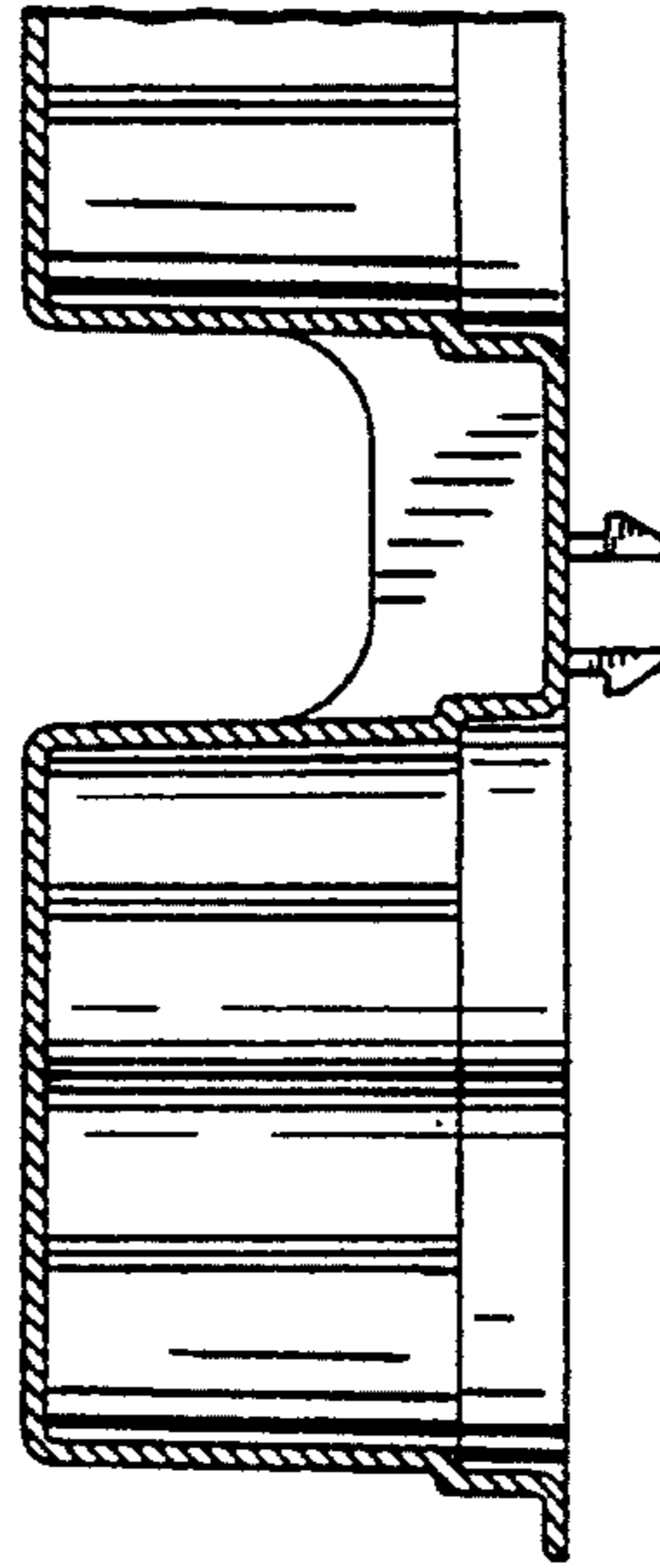

FIG. 5

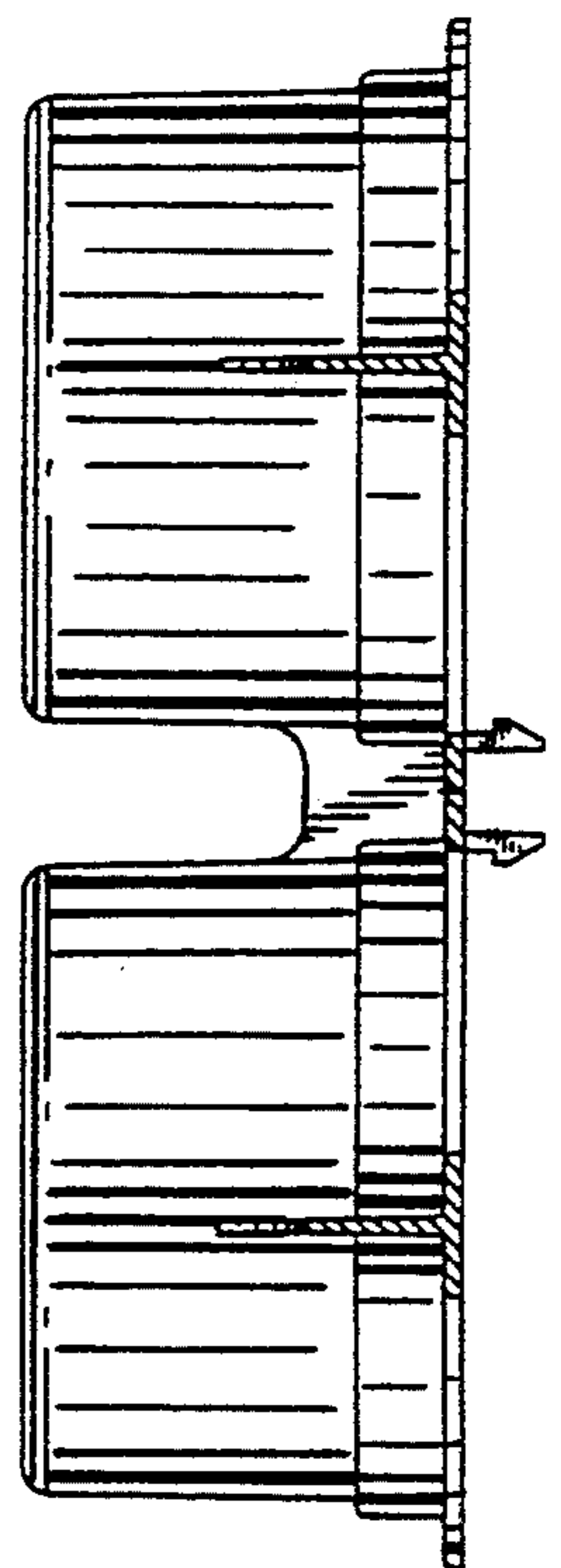

FIG. 7

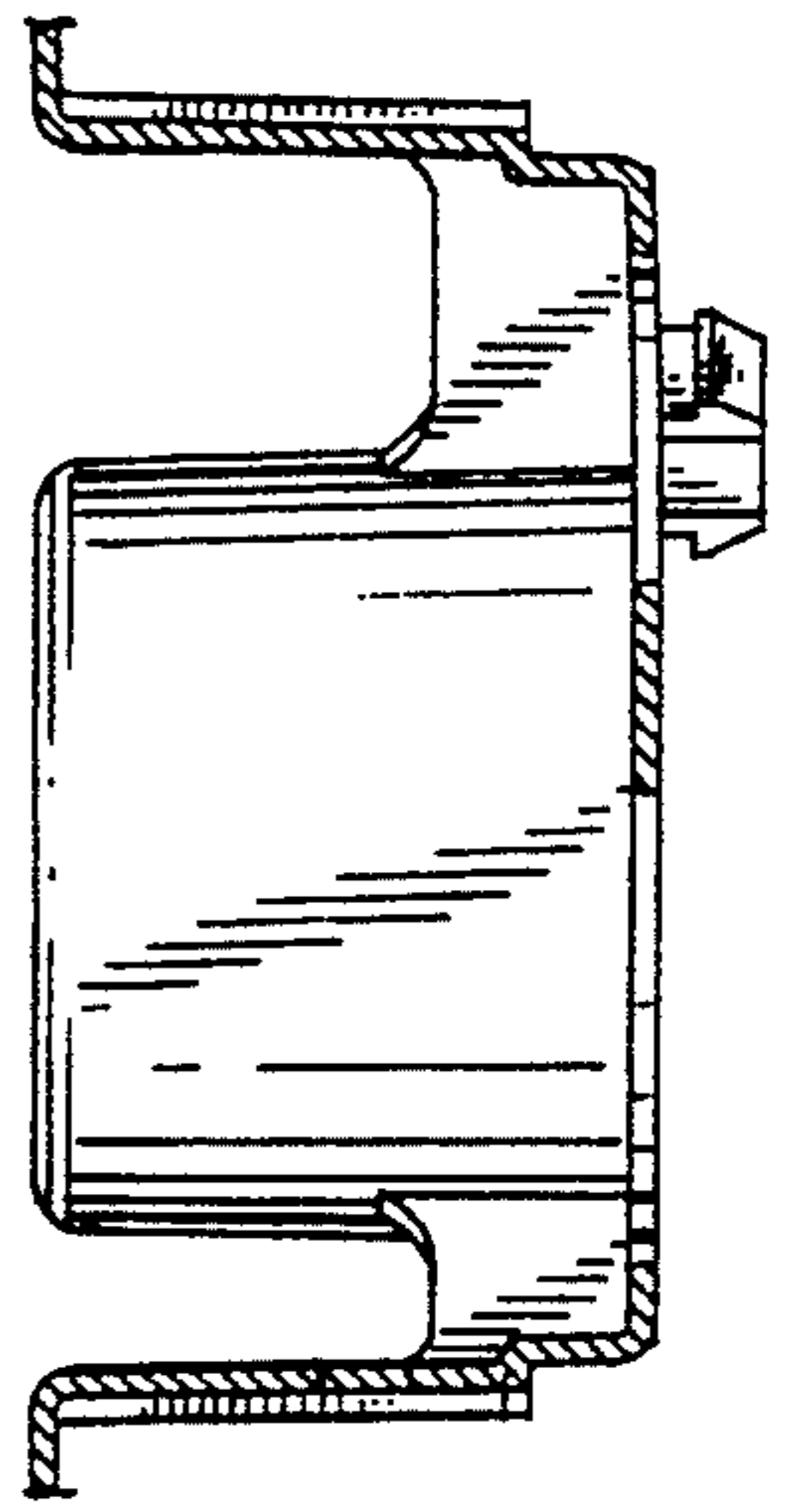

FIG. 8

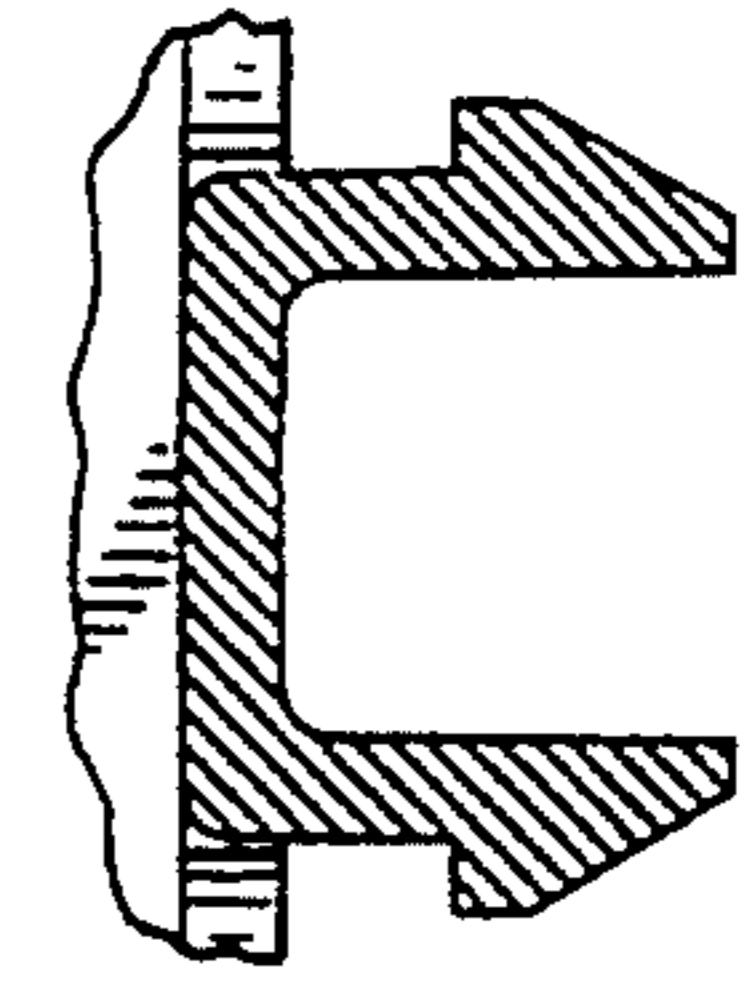

FIG. 9

