



US00D356910S

# United States Patent [19]

[11] Patent Number: **Des. 356,910**

Tatum et al.

[45] Date of Patent: **\*\* Apr. 4, 1995**

[54] TABLE

2,502,526 4/1950 Loewen ..... 108/159 X

[75] Inventors: **Michael D. Tatum**, Dallas, Tex.;  
**Robert W. Purdom**, deceased, late of  
Washington, D.C., **Richard E.**  
**Cytowic**, executor

### OTHER PUBLICATIONS

Wards-Fall/Winter 1979, p. 1110, item #7 at center  
right.

*Antiques*-May 1977, p. 1013, Table at top left.

*Antiques*-May 1976, p. 975 Table at bottom left.

[73] Assignee: **Kimball International, Inc.**, Jasper,  
Ind.

*Primary Examiner*-Janice E. Seeger

*Attorney, Agent, or Firm*-Baker & Daniels

[\*\*] Term: **14 Years**

### [57] CLAIM

[21] Appl. No.: **9,373**

The ornamental design for a table, as shown and de-  
scribed.

[22] Filed: **Jun. 11, 1993**

### DESCRIPTION

[52] U.S. Cl. .... **D6/480; D6/451**

[58] Field of Search ..... **D6/480-489,**  
**D6/495-499, 511, 429, 451; 108/115, 117, 127,**  
**153, 156, 161, 159**

FIG. 1 is a perspective view the table showing our new  
design;

FIG. 2 is a front view thereof;

FIG. 3 is a side view thereof;

FIG. 4 is a perspective side view thereof;

FIG. 5 is a top view thereof; and,

FIG. 6 is a top view of an alternate embodiment of the  
table in which the shade lines indicate the direction of  
the wood grain of the material.

### [56] References Cited

#### U.S. PATENT DOCUMENTS

- D. 70,164 5/1926 Erskine ..... D6/480
- D. 147,990 11/1947 Reynolds ..... D6/483
- D. 241,395 9/1976 Perl ..... D6/480 X

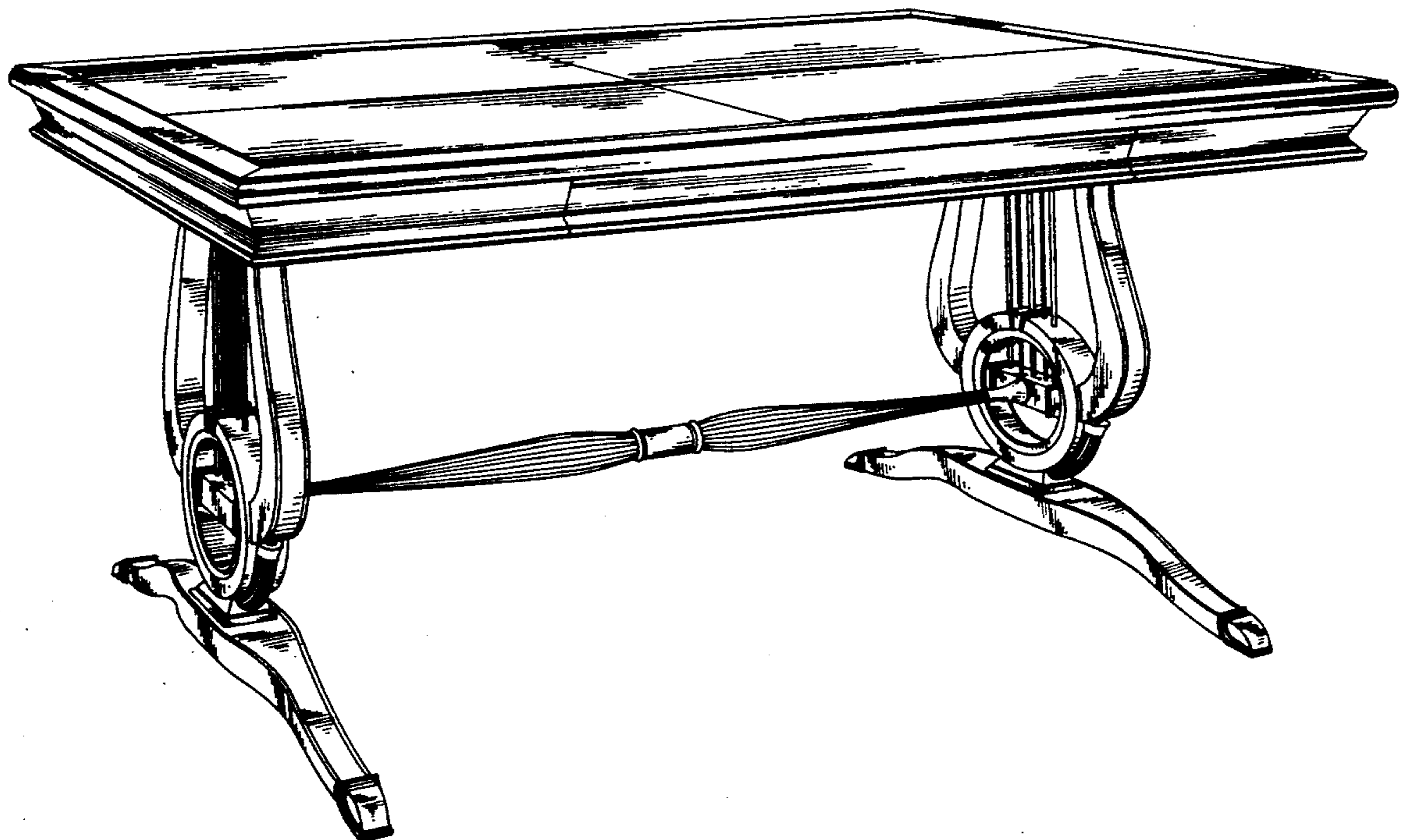

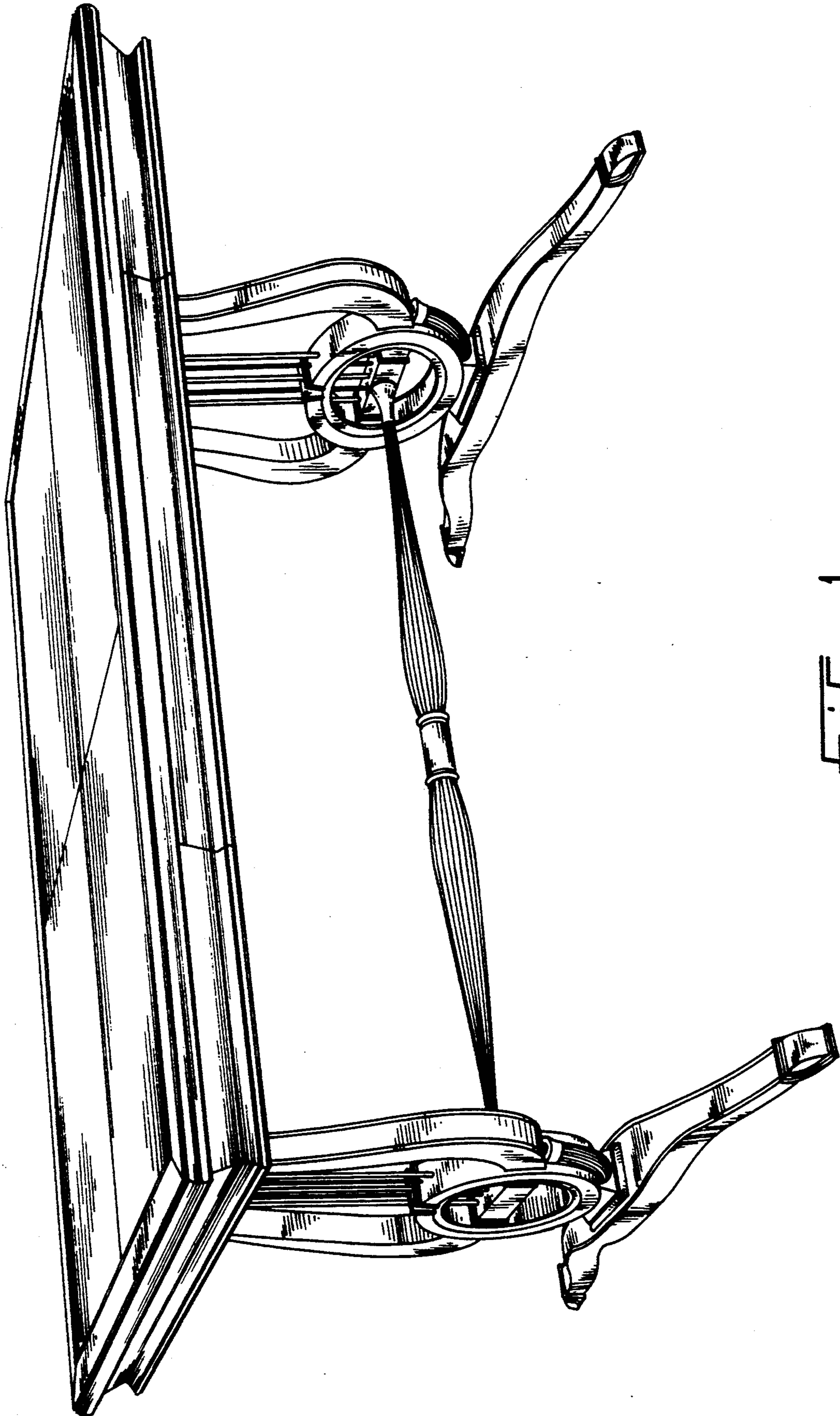

FIG. 1

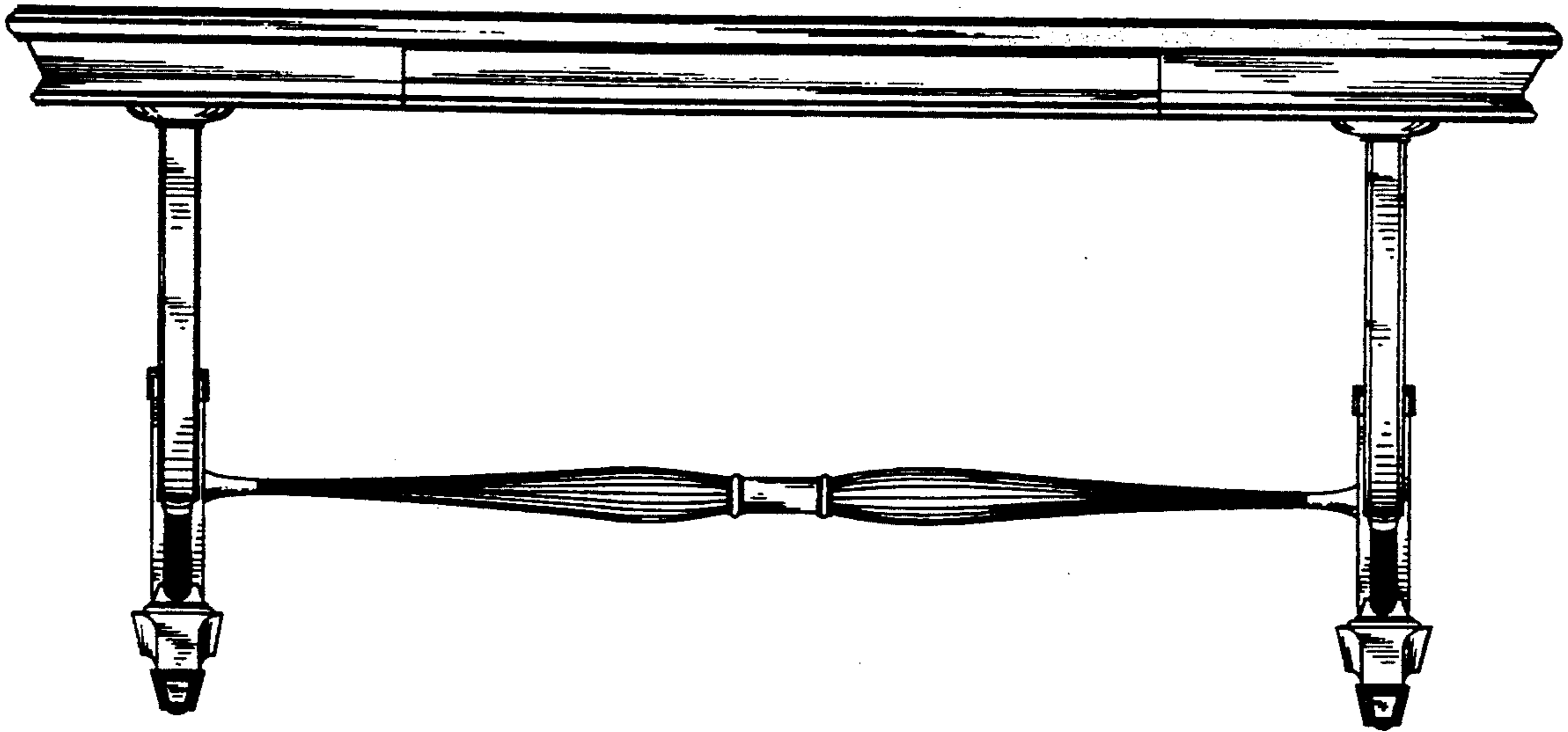

FIG. 2

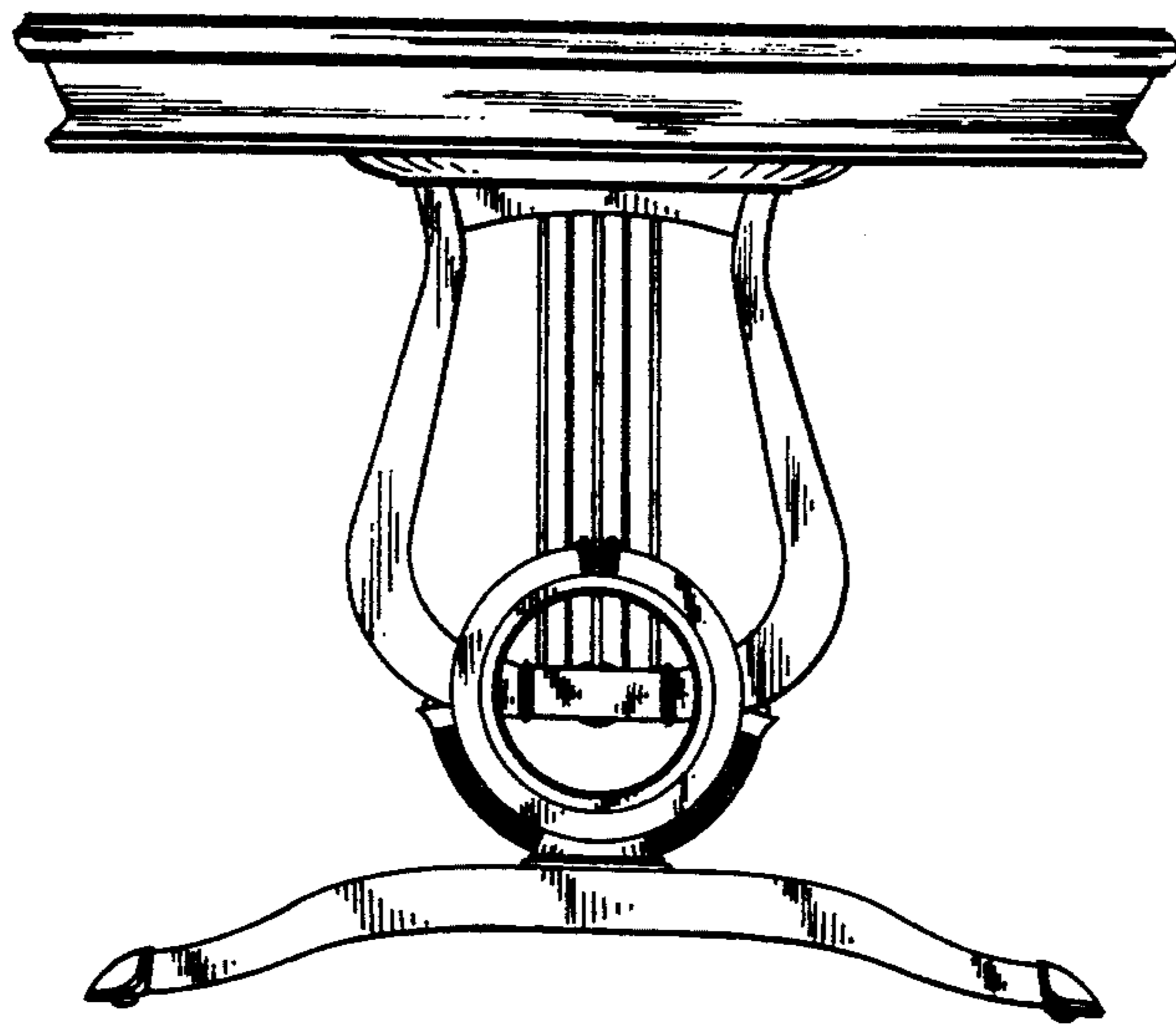

FIG. 3

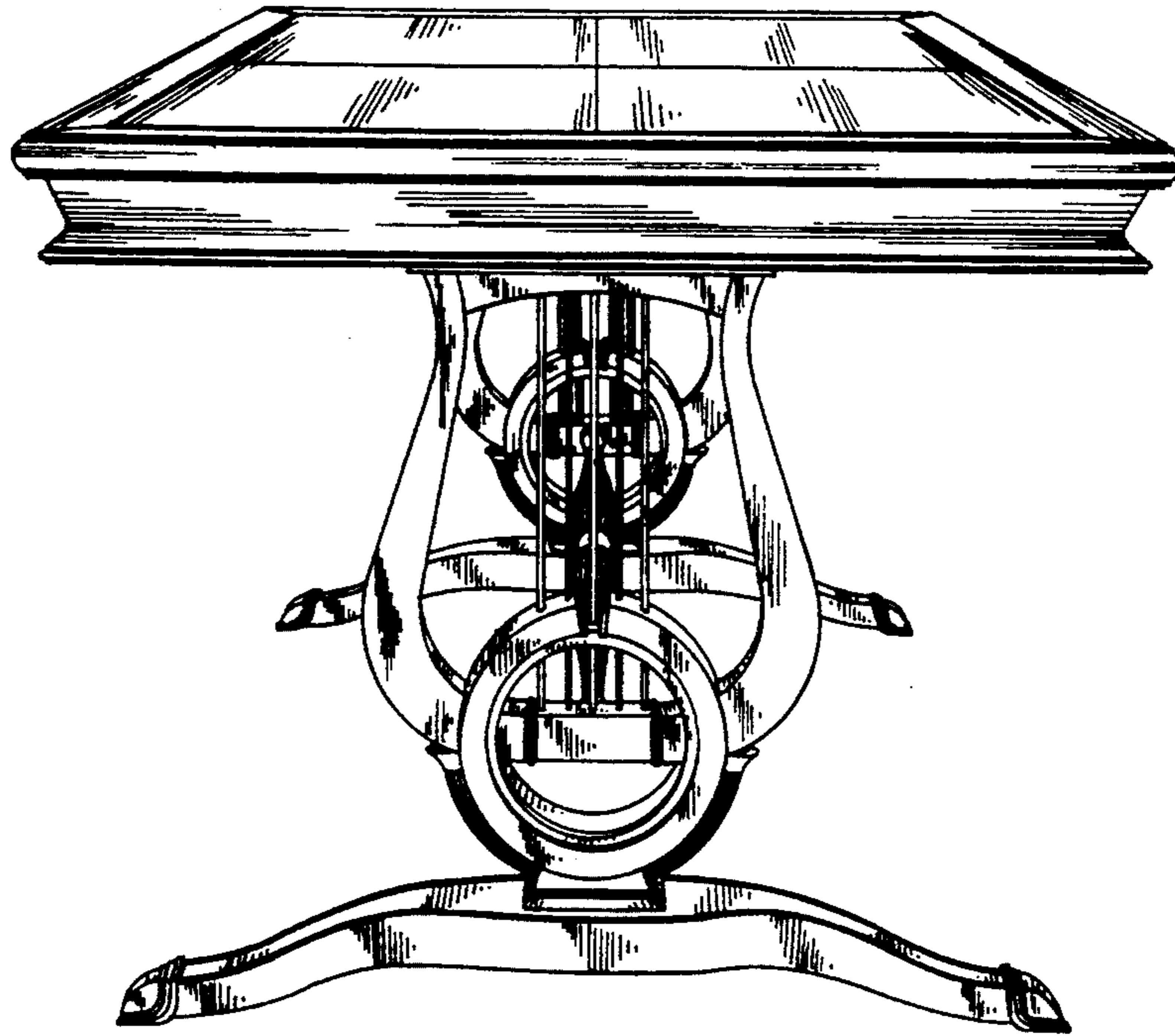

FIG. 4

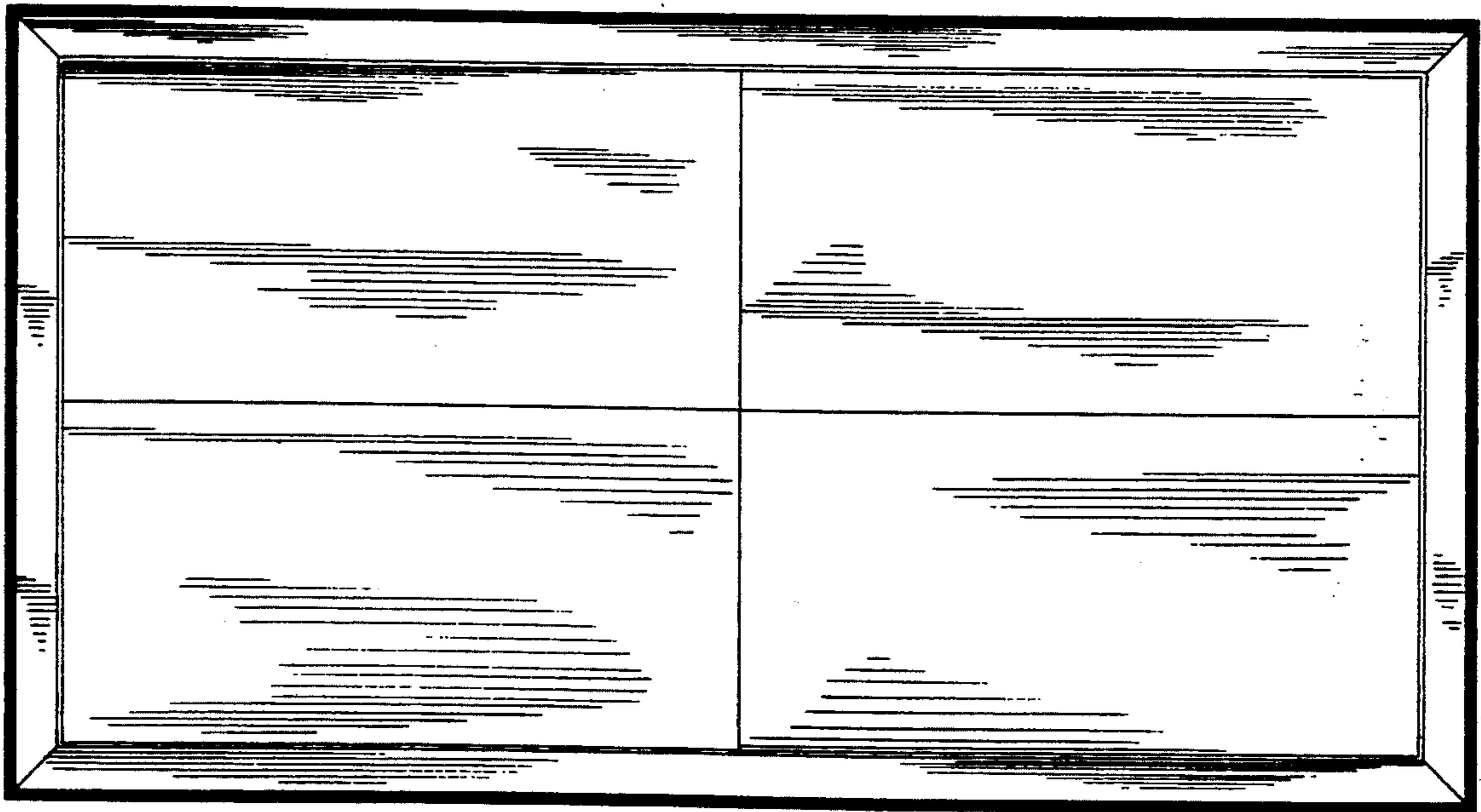

FIG. 5

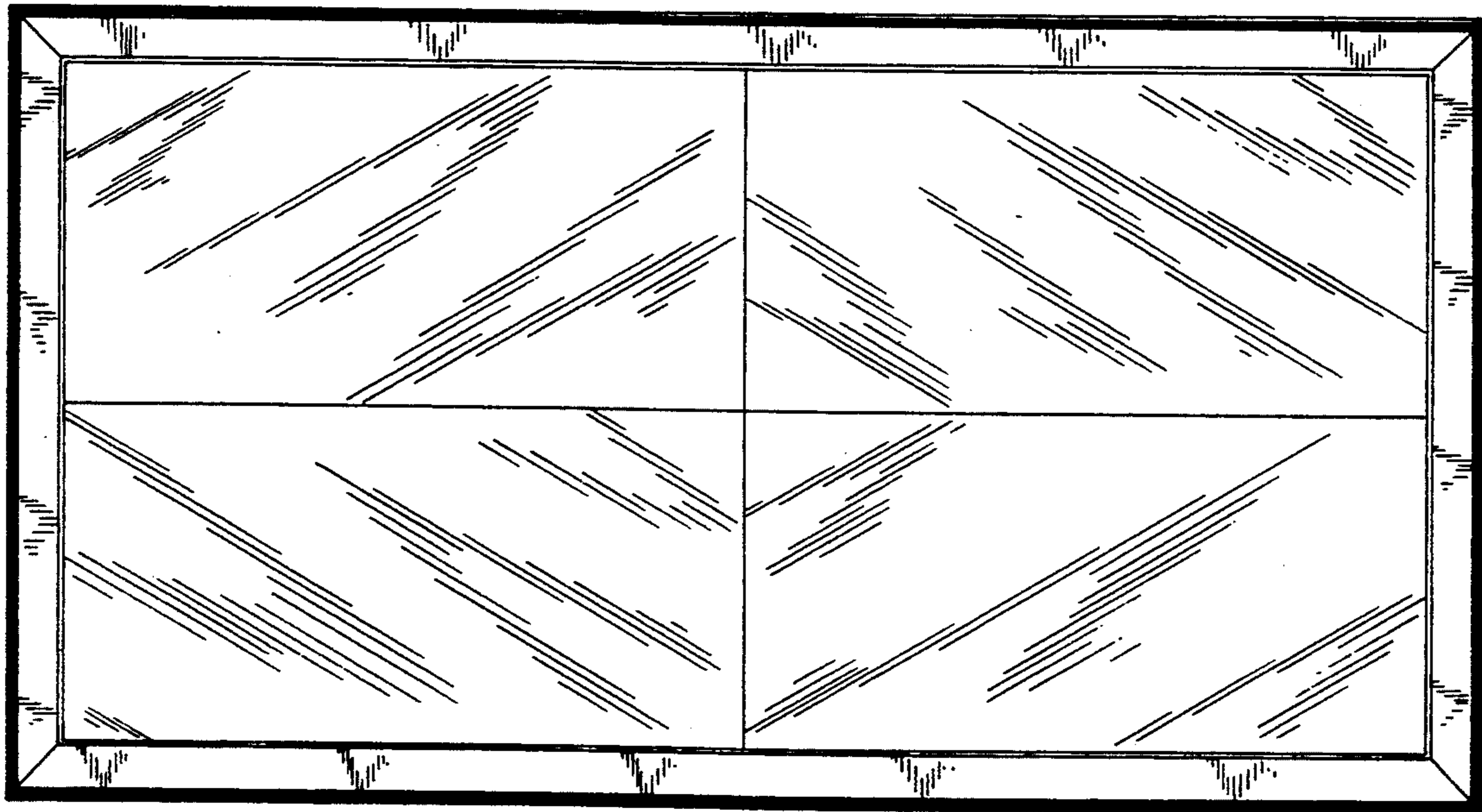

FIG. 6