



US00D356850S

United States Patent [19] Hoffpauir

[11] Patent Number: **Des. 356,850**

[45] Date of Patent: **** Mar. 28, 1995**

[54] **FISHING LURE**

[76] Inventor: **Terry L. Hoffpauir**, 117 Babin St.,
Houma, La. 70364

[**] Term: **14 Years**

[21] Appl. No.: **7,966**

[22] Filed: **May 6, 1993**

[52] U.S. Cl. **D22/129**

[58] Field of Search **D22/129, 130; 43/42.2,**
43/42.17, 42.18, 42.19, 42.13, 43.14, 42.31,
42.11

4,793,089 12/1988 Long et al. 43/42.13
 4,930,247 6/1990 DuBois 43/42.31
 5,024,019 6/1991 Rust et al. 43/42.31
 5,050,334 9/1991 Standish, Jr. 43/42.13
 5,138,789 8/1992 Hood 43/42.13

Primary Examiner—A. Hugo Word
Assistant Examiner—Doris V. Coles
Attorney, Agent, or Firm—George A. Bode

[57] **CLAIM**

The ornamental design for a fishing lure, as shown and described.

DESCRIPTION

FIG. 1 is a top perspective view of a fishing lure showing my new design;
 FIG. 2 is a top plan view thereof;
 FIG. 3 is a rear elevational view thereof;
 FIG. 4 is a left side inverted view thereof;
 FIG. 5 is a right side view thereof;
 FIG. 6 is a bottom plan view thereof; and,
 FIG. 7 is a front elevational view thereof.

[56] **References Cited**

U.S. PATENT DOCUMENTS

2,819,554	1/1958	Neale	43/42.18
3,093,923	6/1963	Jackson	43/42.11
4,201,008	5/1980	Sparkman	43/43.14 X
4,510,710	4/1985	Hanna et al.	43/42.13
4,619,068	10/1986	Wotawa	43/42.11
4,745,700	5/1988	Davis	43/42.13

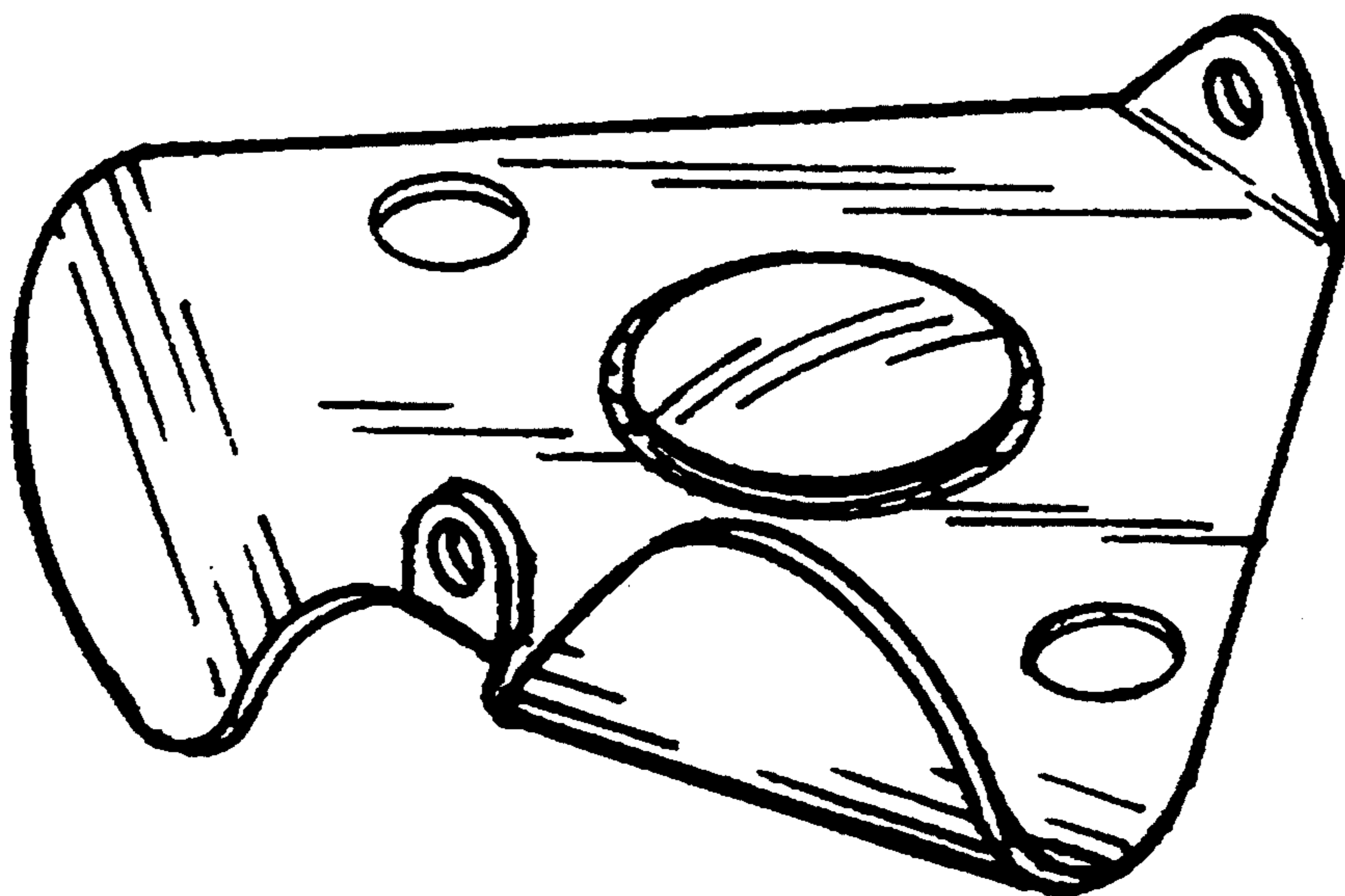

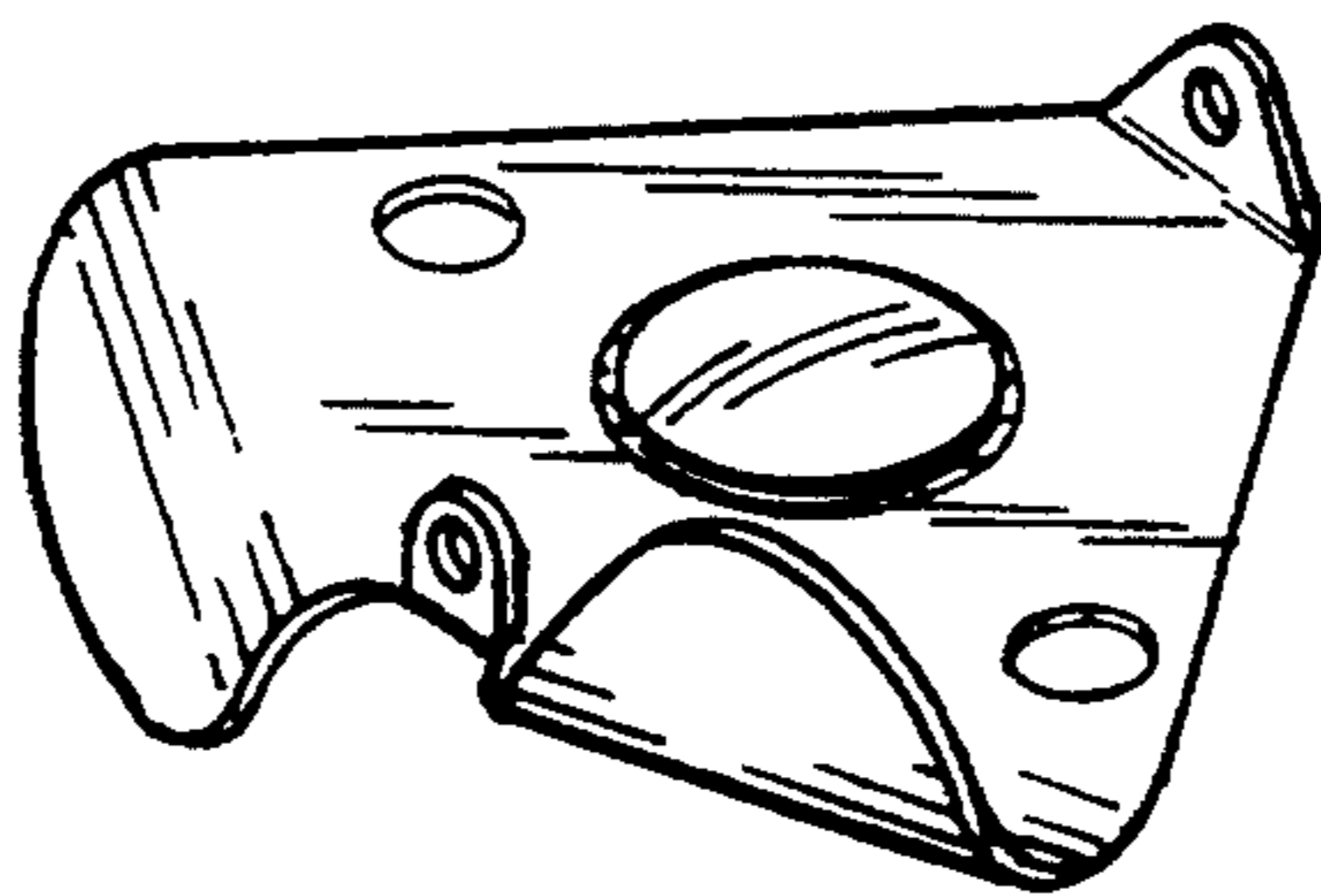

FIG. 1

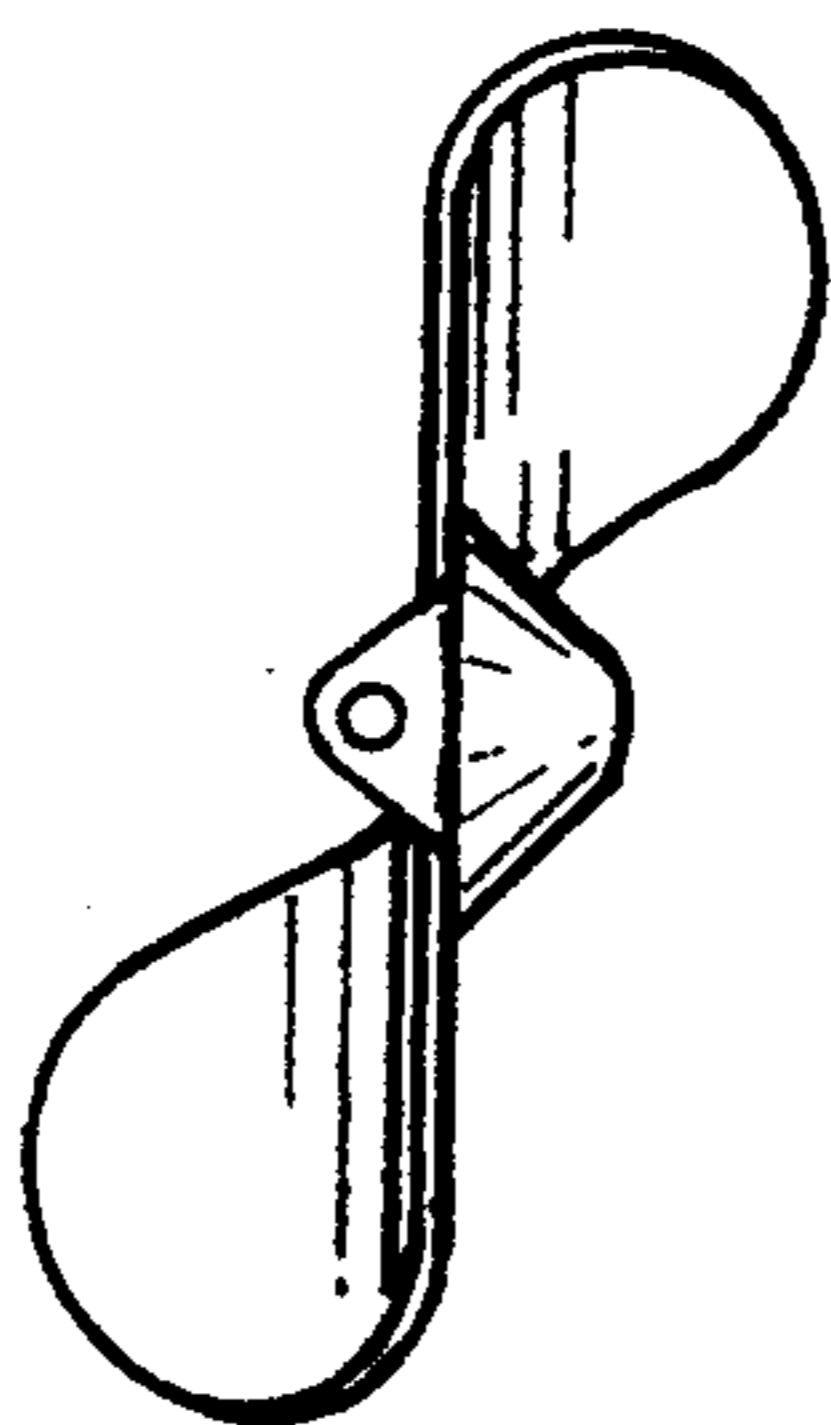

FIG. 3

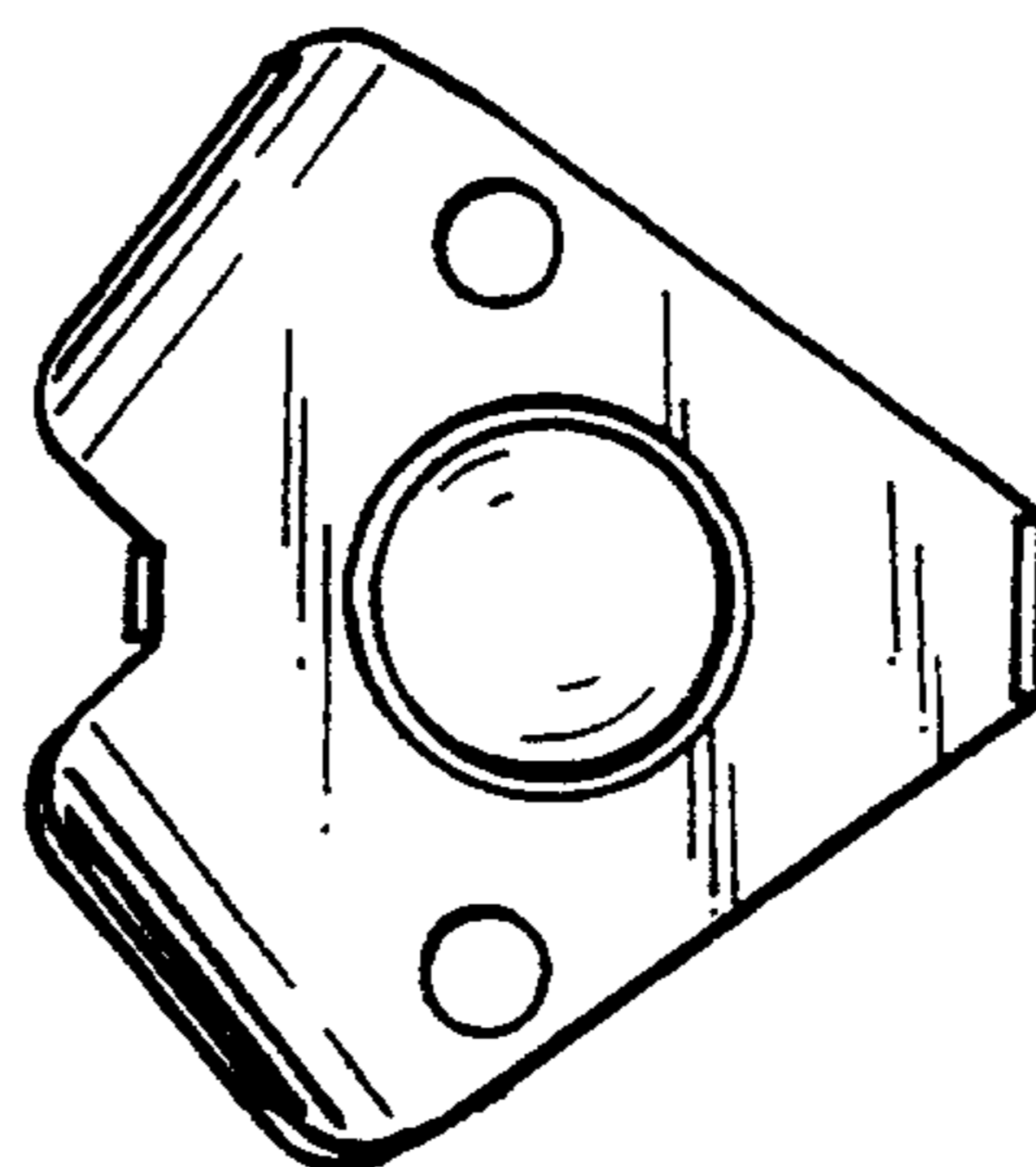

FIG. 2

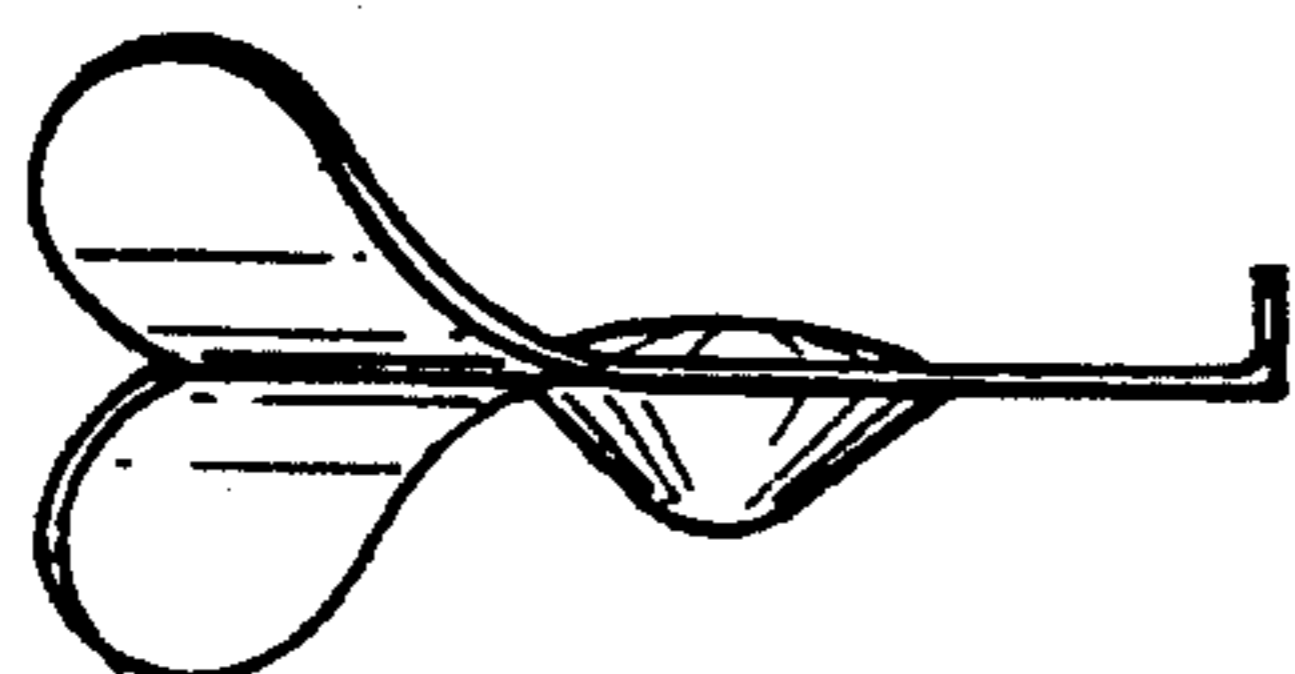

FIG. 5

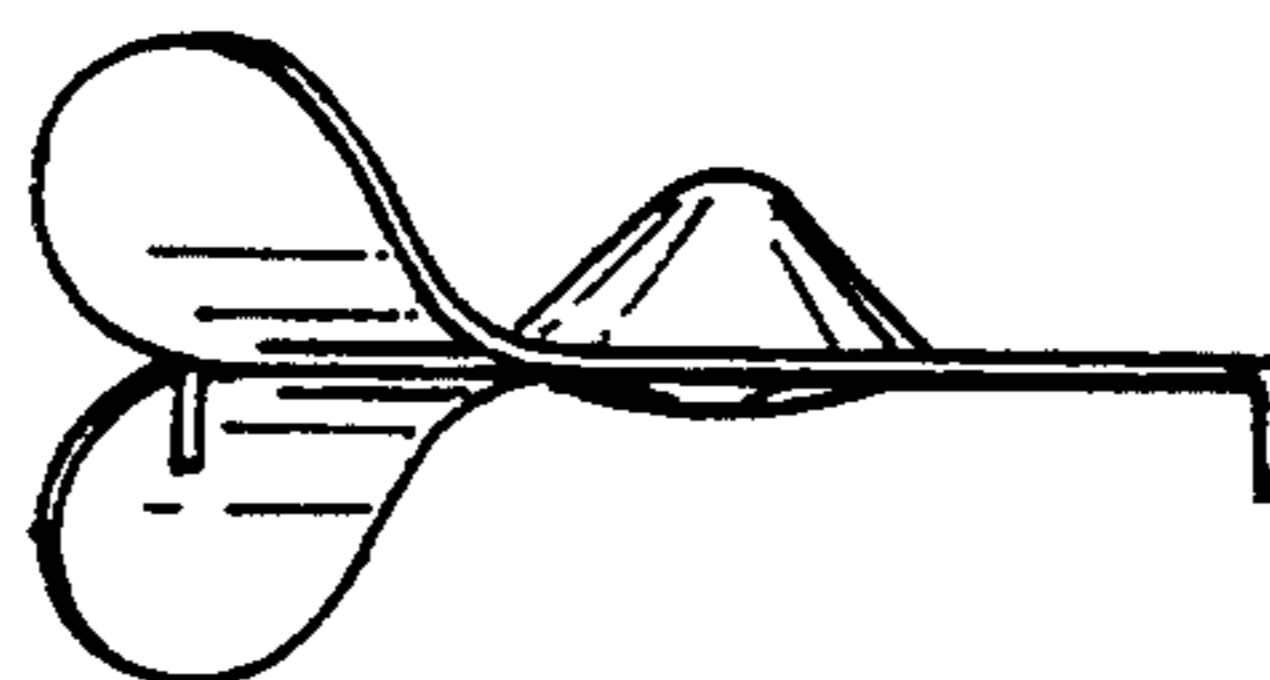

FIG. 4

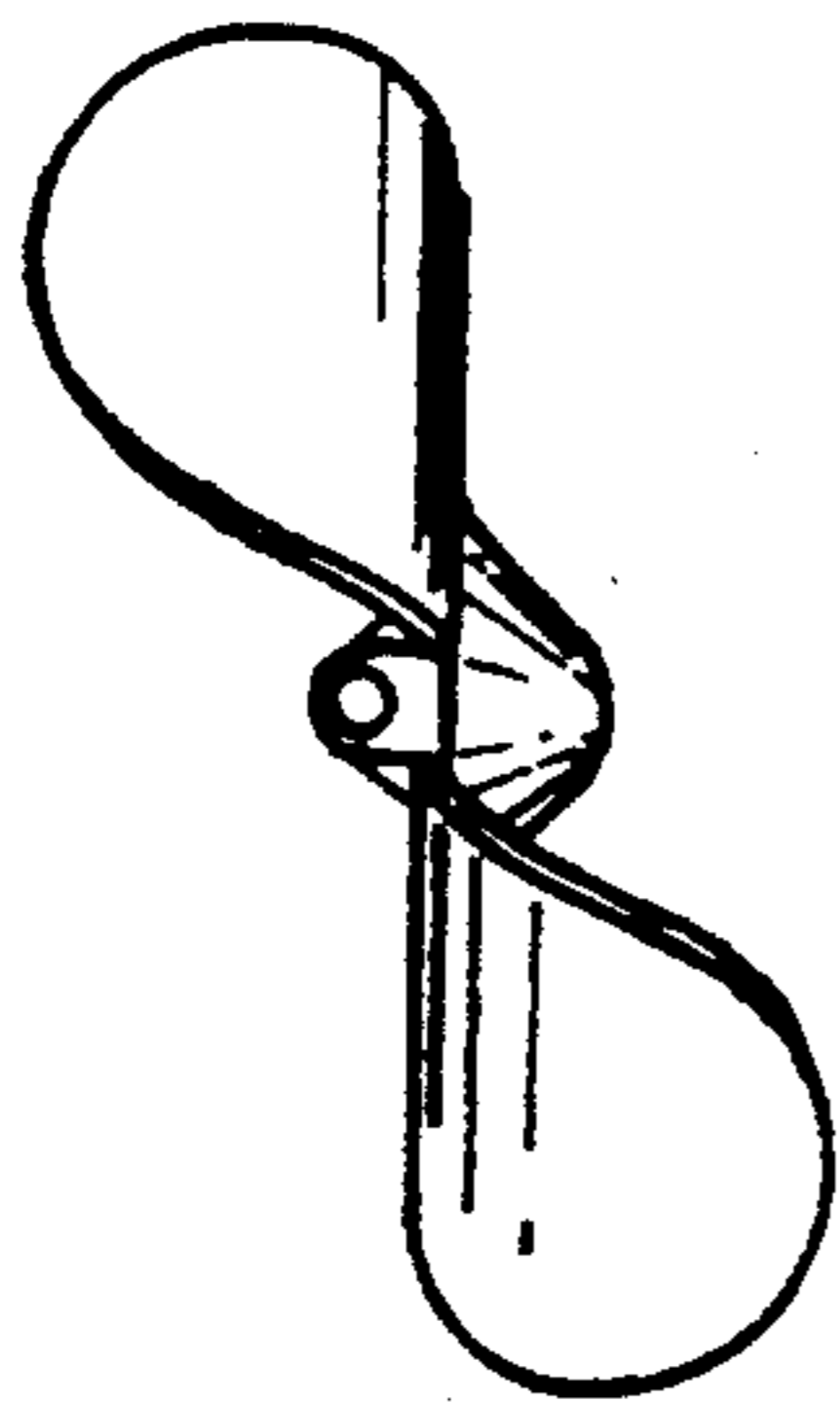

FIG. 7

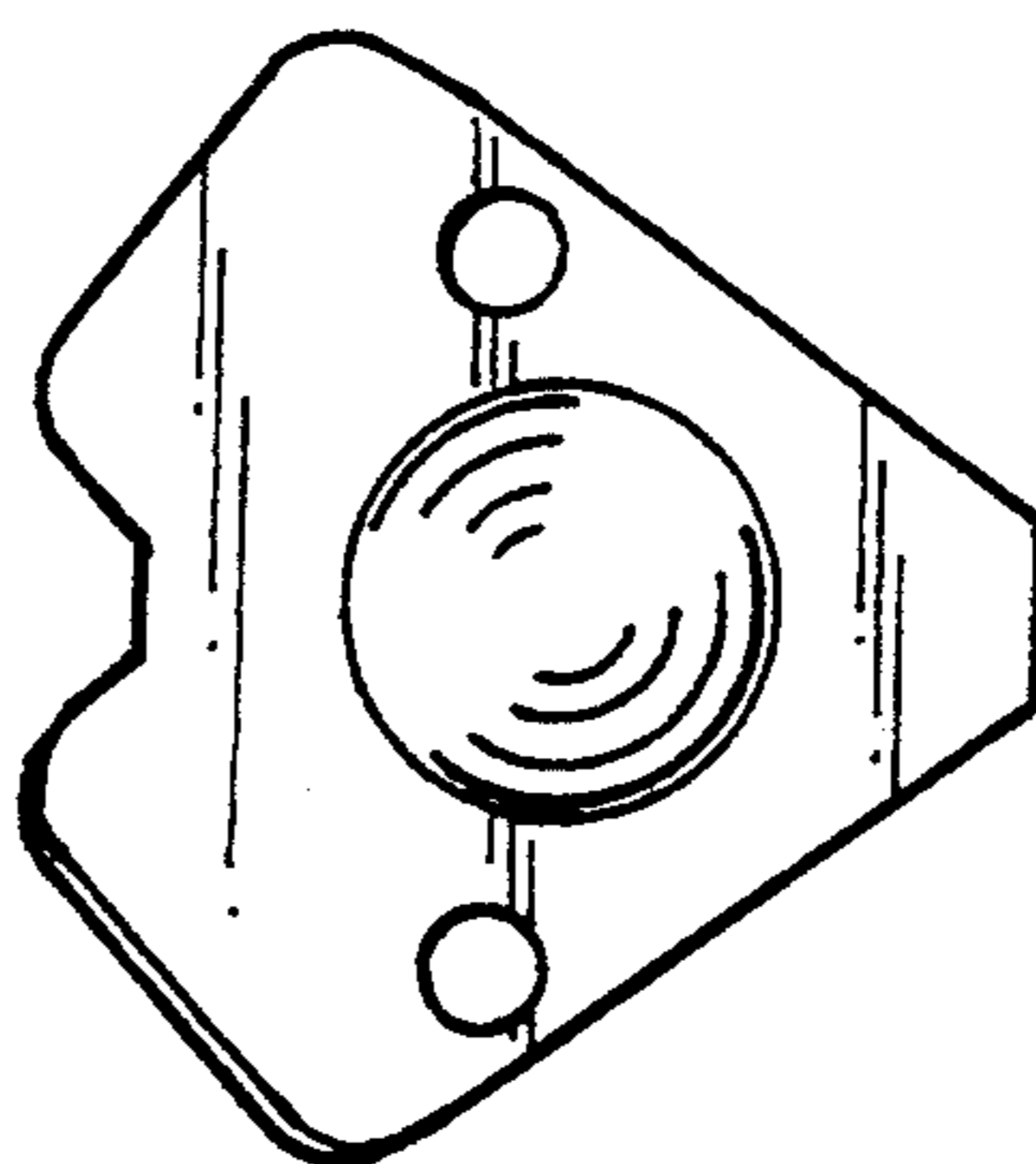

FIG. 6