



US00D356708S

# United States Patent [19]

[11] Patent Number: **Des. 356,708**

Shames et al.

[45] Date of Patent: **\*\* Mar. 28, 1995**

## [54] BATHROOM ACCESSORY FIXTURE

[76] Inventors: **Sidney J. Shames**, 57 Holly Pl., Briarcliff Manor, N.Y. 10510; **Harold Shames**, 5 Agnes Cir., Ardsley, N.Y. 10502

[\*\*] Term: **14 Years**

[21] Appl. No.: **14,352**

[22] Filed: **Oct. 19, 1993**

[52] U.S. Cl. .... **D6/527; D6/531; D6/534; D6/535; D6/540**

[58] Field of Search ..... **D6/527-529, D6/531-532, 534-536, 540; 211/13, 86-87, 90, 134; 248/309.1, 311.2, 360; 206/77.1**

## [56] References Cited

### U.S. PATENT DOCUMENTS

D. 236,323	8/1975	Johnsen et al. ....	D6/546 X
D. 291,519	8/1987	Chap .....	D6/531
D. 299,095	12/1988	Gresens et al. ....	D6/531 X
D. 337,681	7/1993	Sharpe .....	D6/531
D. 346,928	5/1994	Shames et al. ....	D6/540
D. 347,346	5/1994	Shames et al. ....	D6/531

## OTHER PUBLICATIONS

Home Decorators Collection Catalogue p. 56, Avanti items "M" and N.

*Primary Examiner*—Brian N. Vinson  
*Attorney, Agent, or Firm*—Bullwinkel Partners, Ltd.

## [57] CLAIM

The ornamental design for a bathroom accessory fixture, as shown and described.

## DESCRIPTION

FIG. 1 is a front elevational view of a bathroom accessory fixture as embodied in a soap dish showing our new design;

FIG. 2 is a top plan thereof;

FIG. 3 is a bottom plan view thereof;

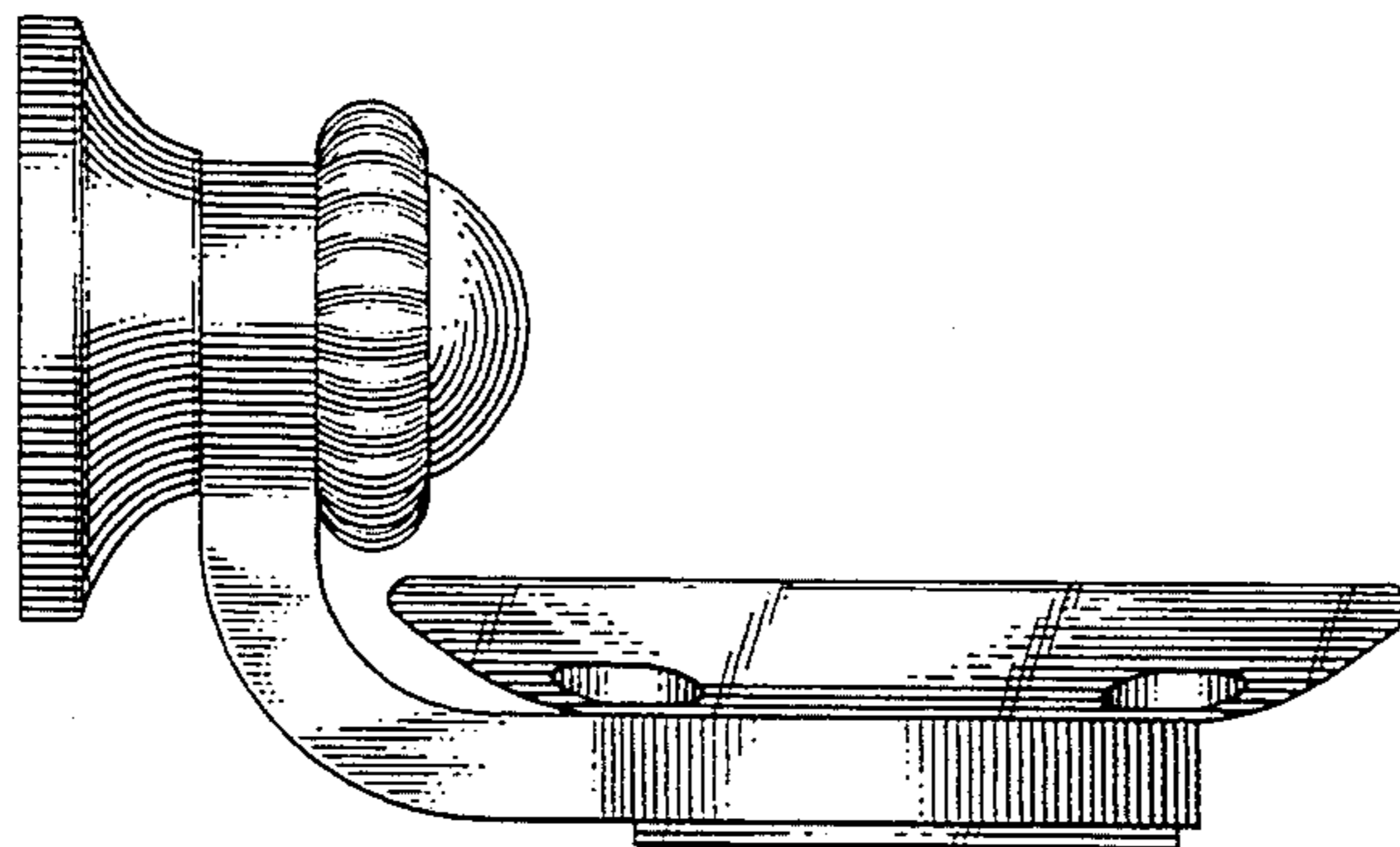
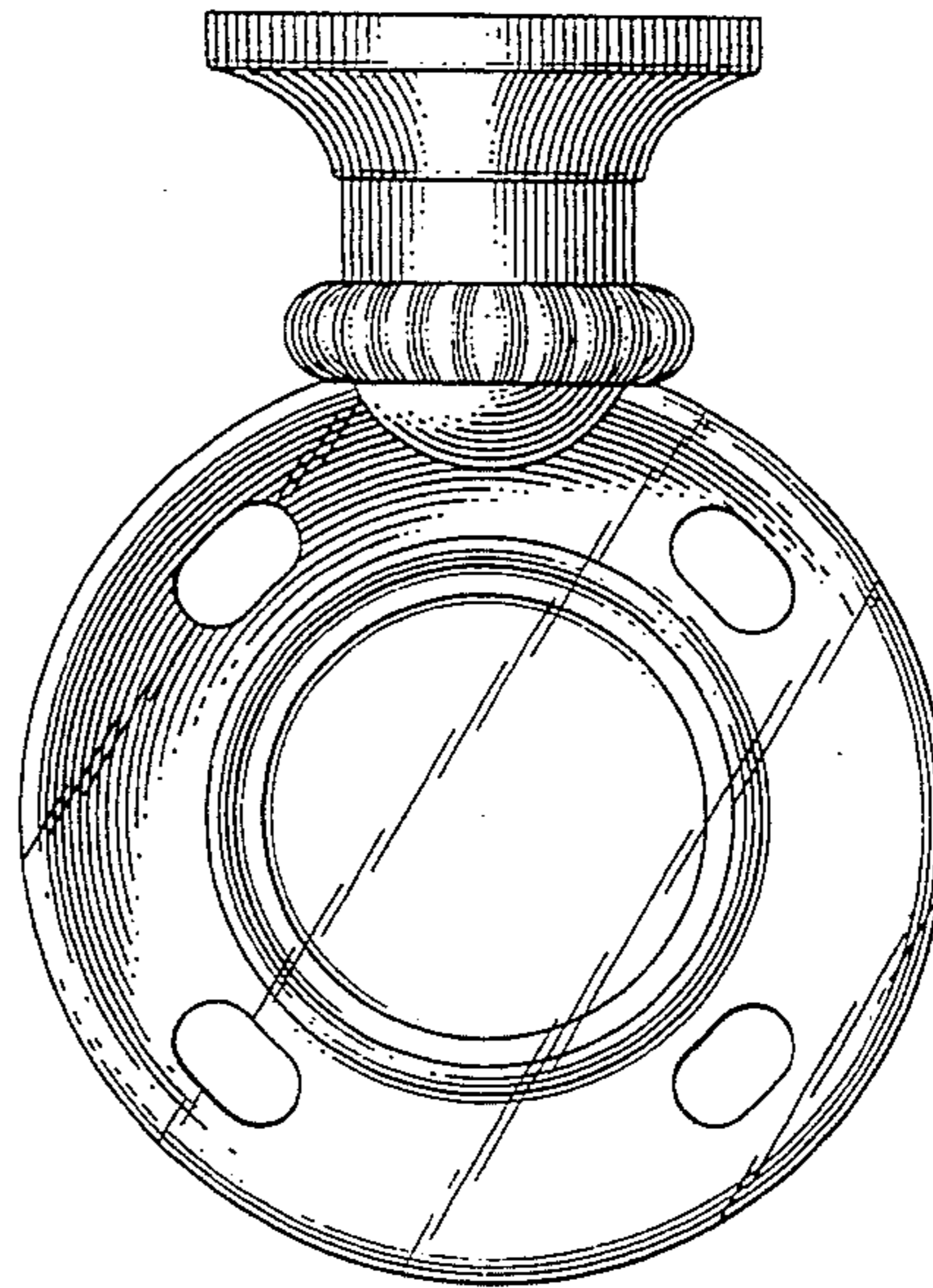
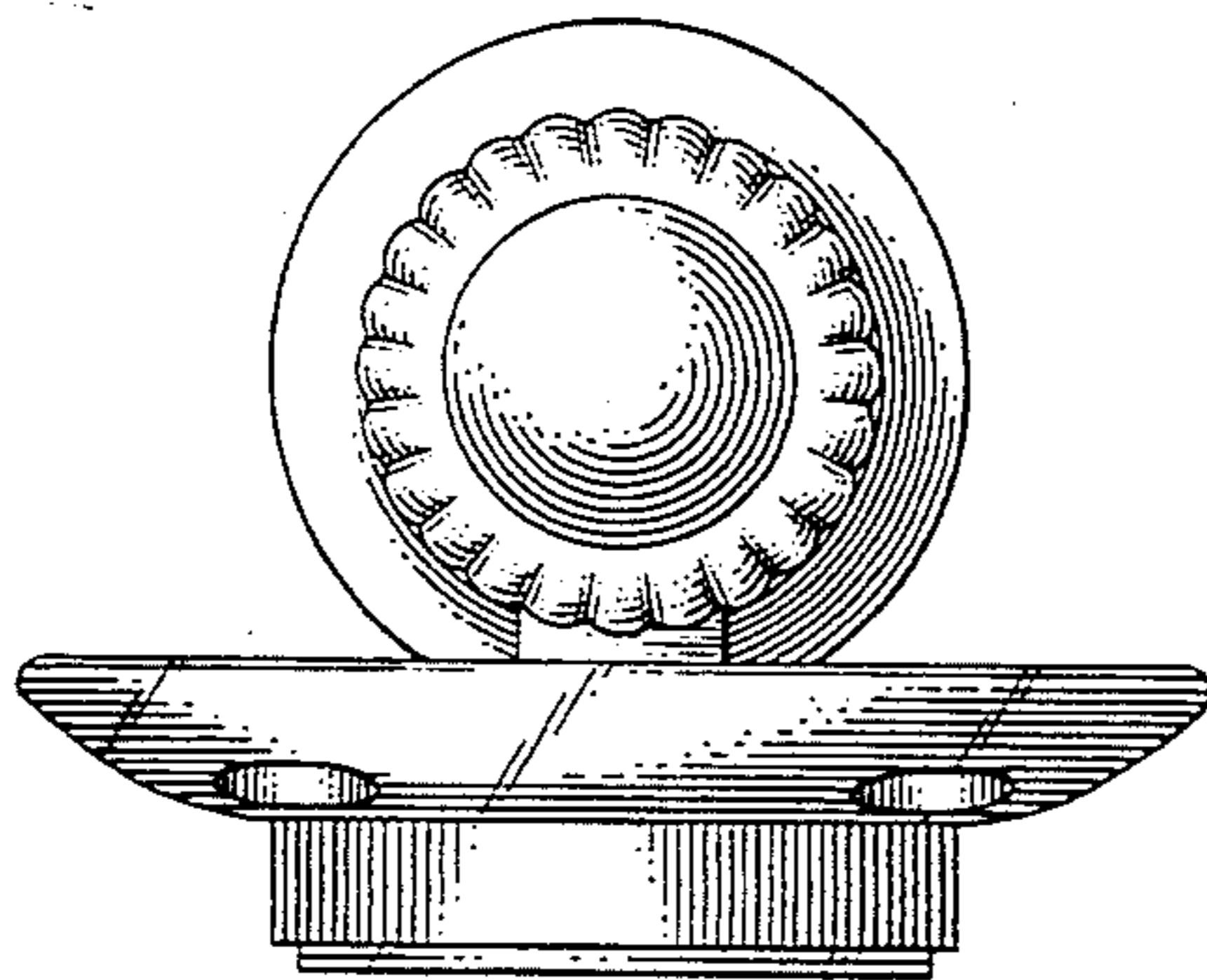
FIG. 4 is a left side elevational view thereof, the opposite side being a mirror image;

FIG. 5 is a front elevational view of a bathroom accessory fixture as embodied in a toothbrush and tumbler holder showing our new design;

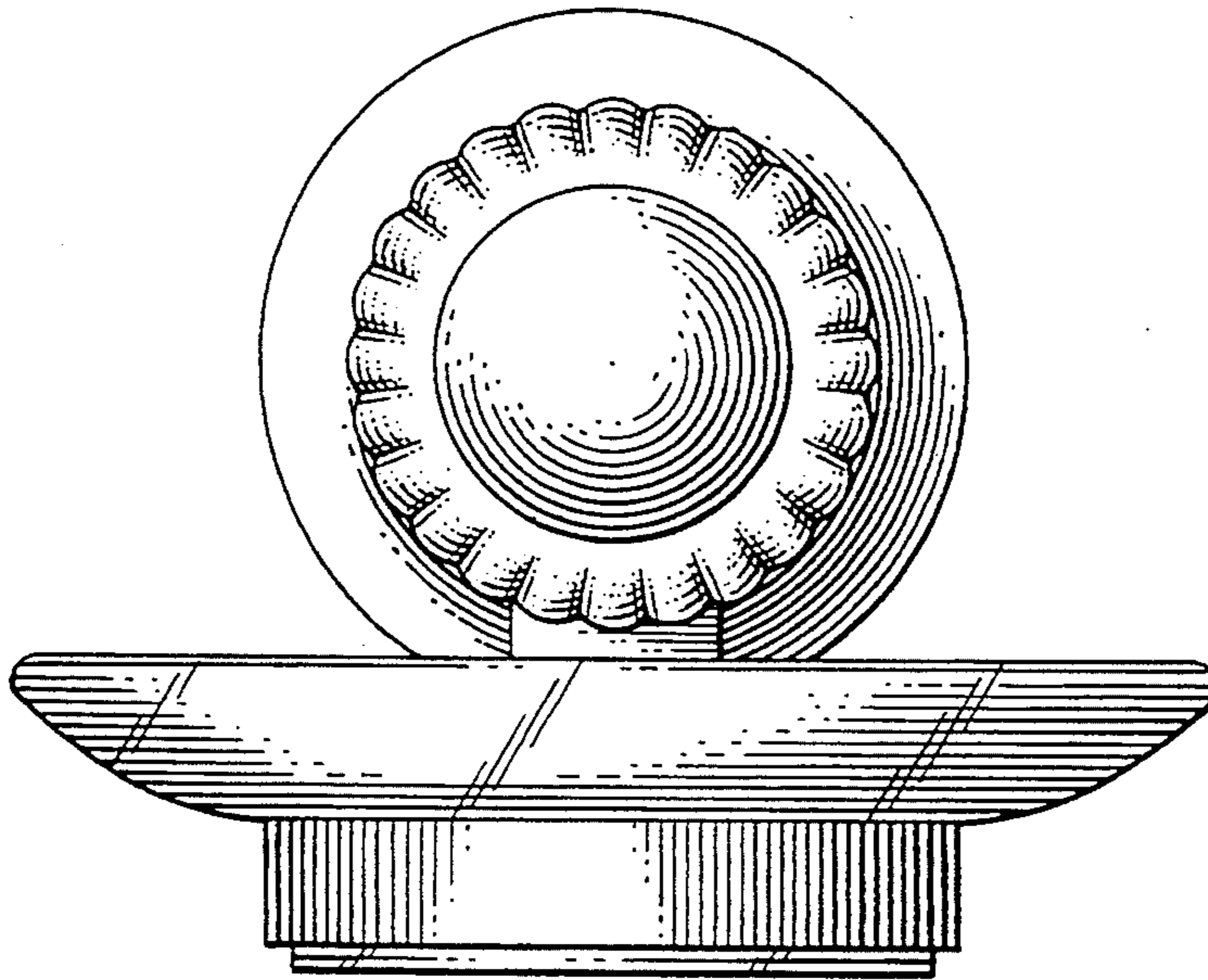
FIG. 6 is a top plan thereof;

FIG. 7 is a bottom plan view thereof; and,

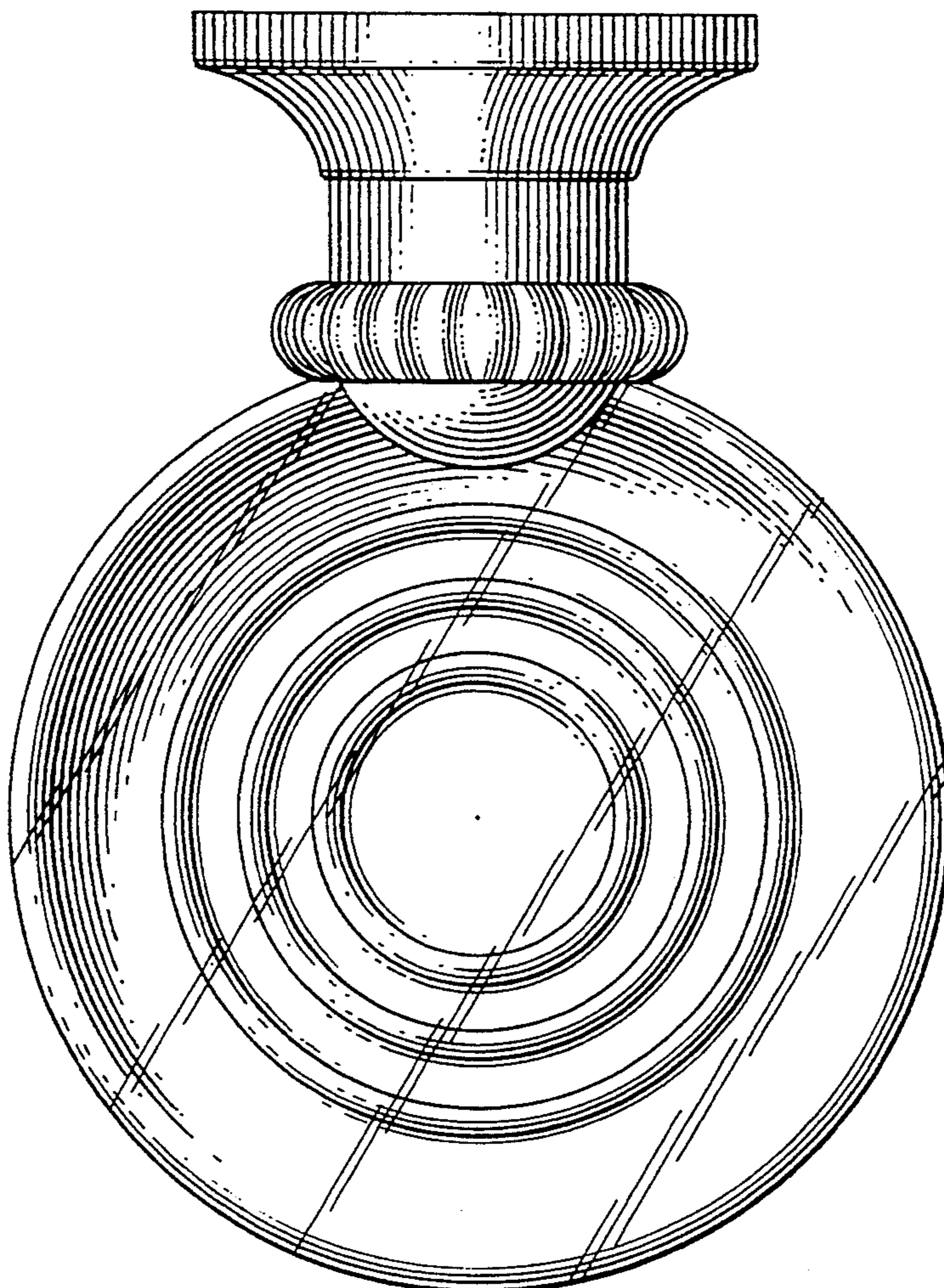
FIG. 8 is a left side elevational view thereof, the opposite side being a mirror image.



*Fig. 1*

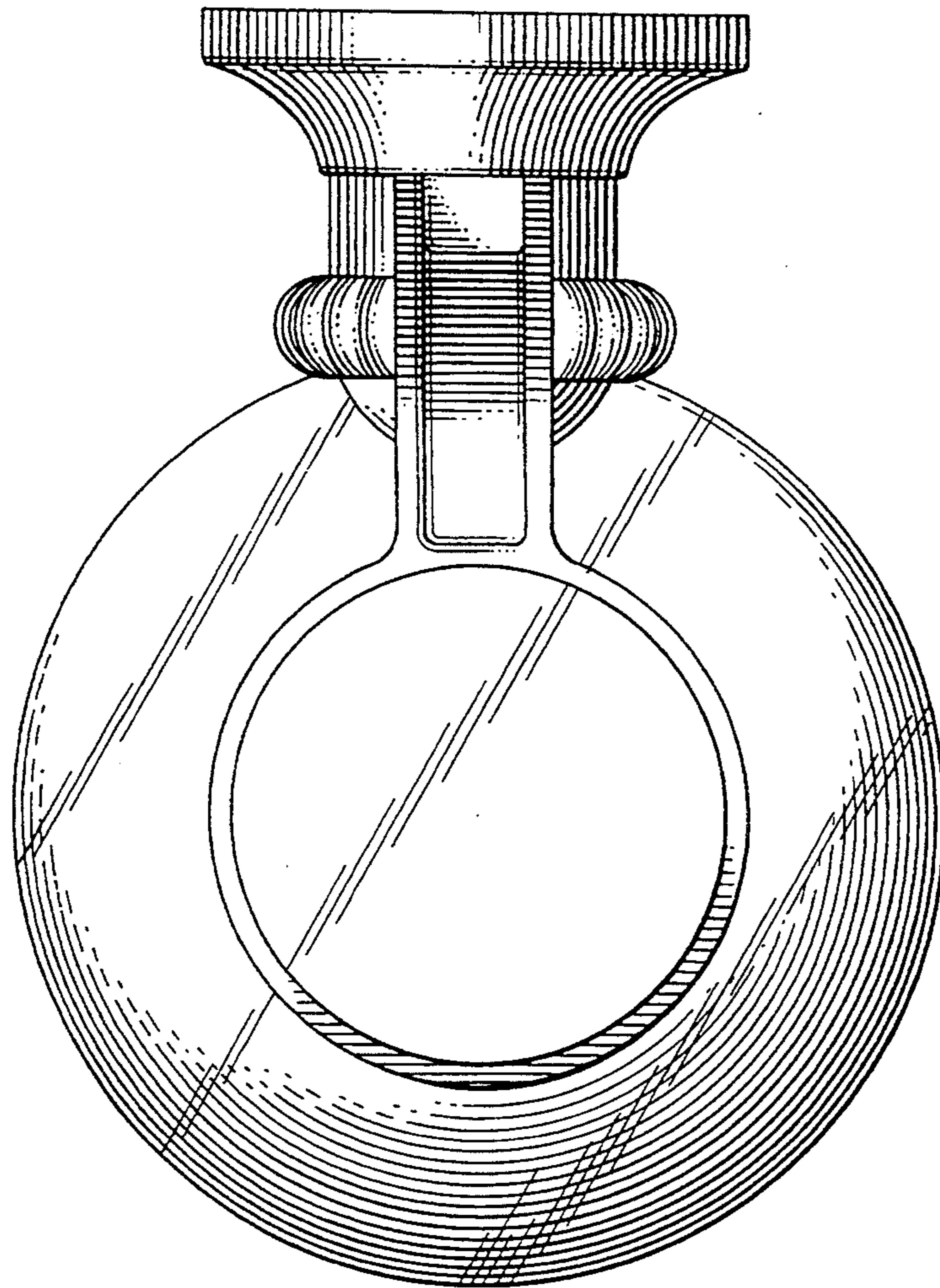


*Fig. 2*

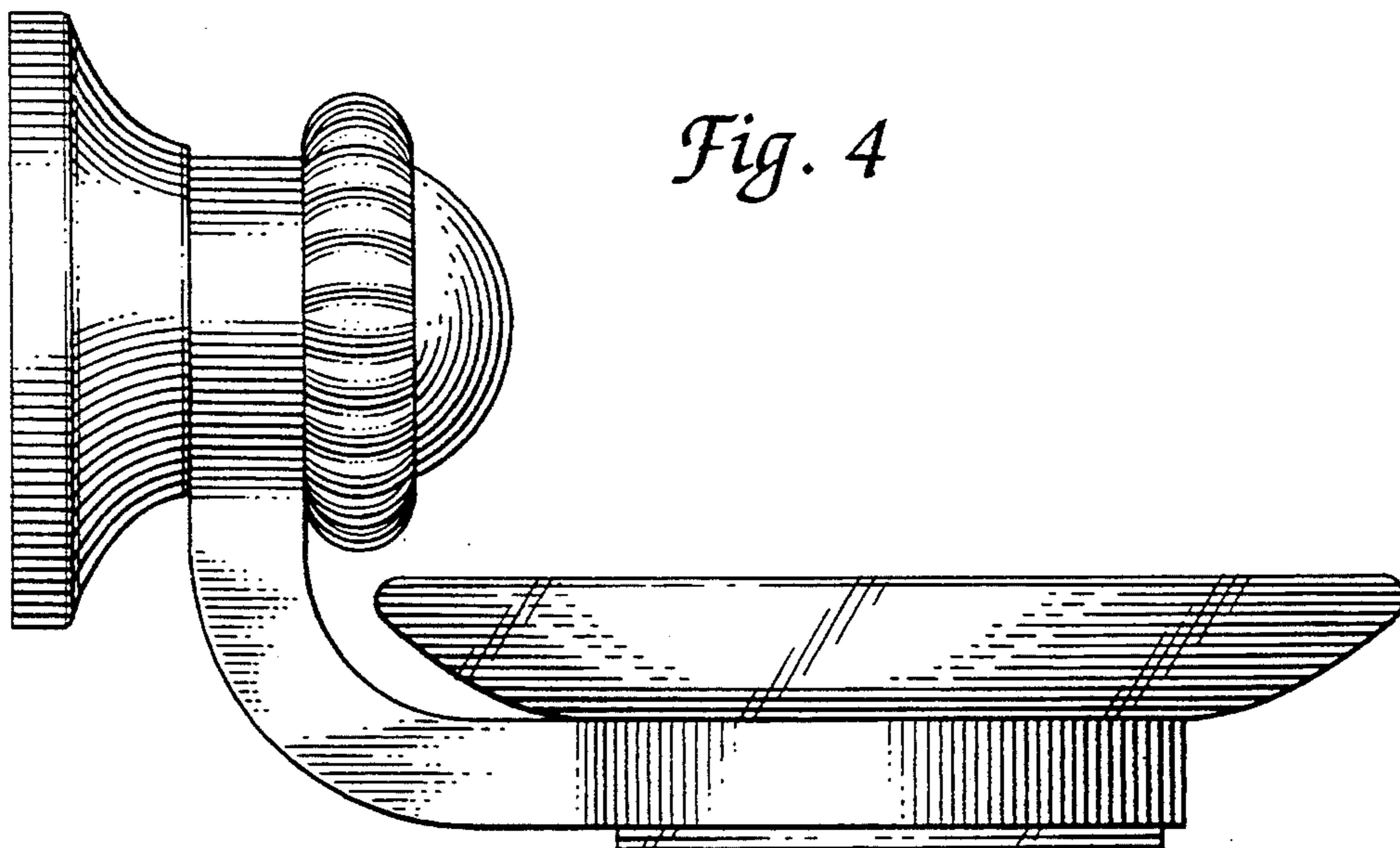




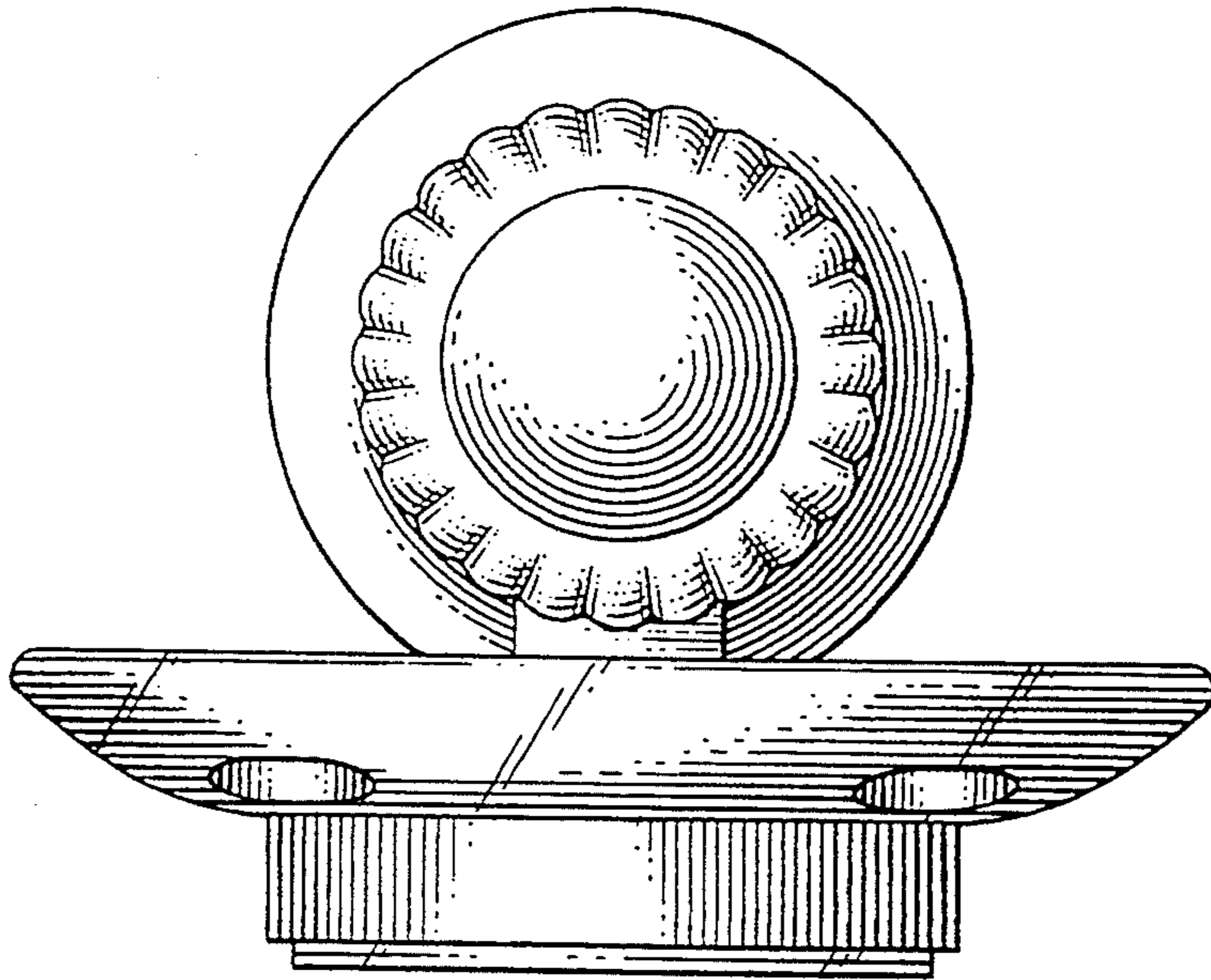
*Fig. 3*



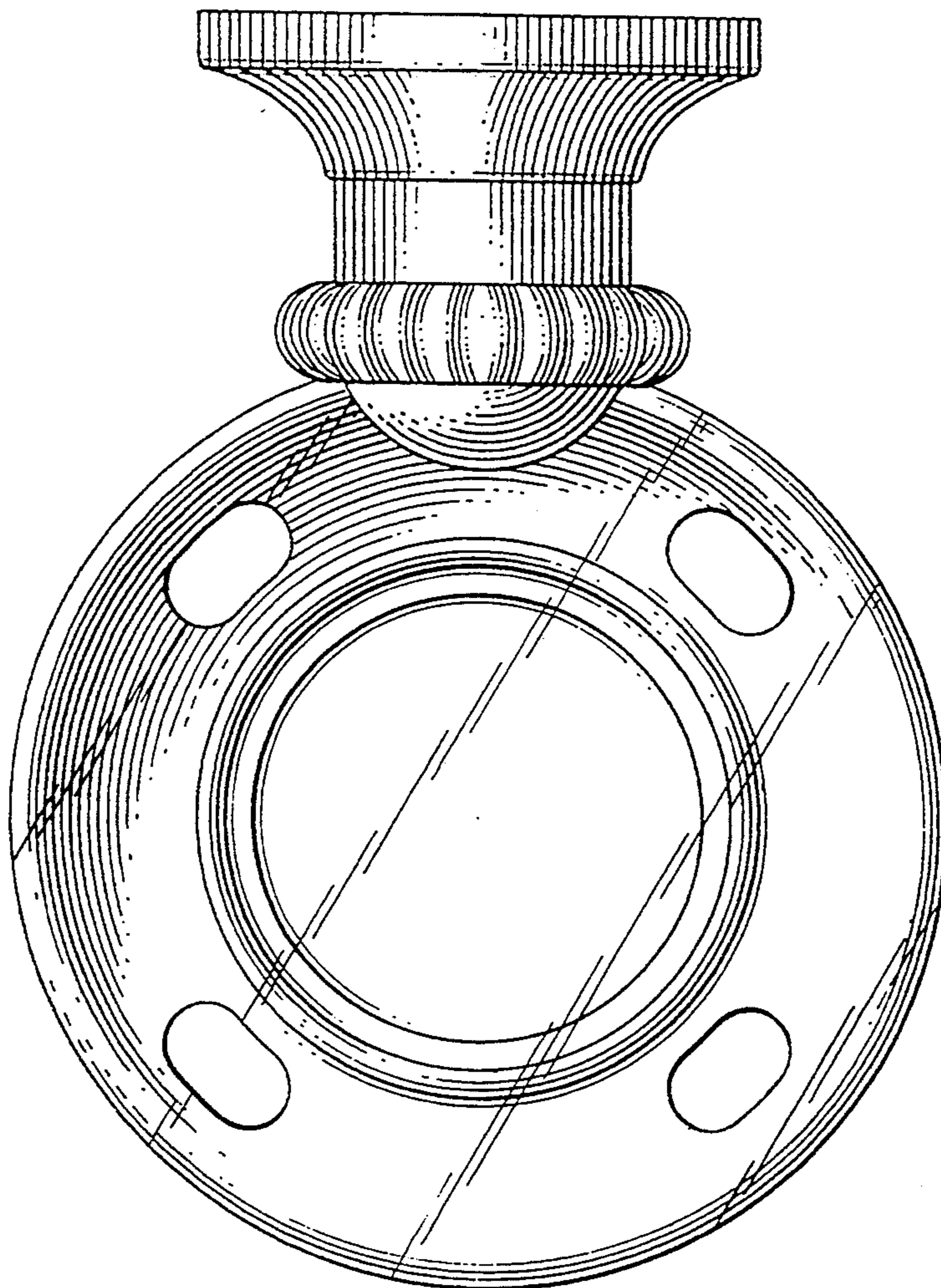
*Fig. 4*



*Fig. 5*

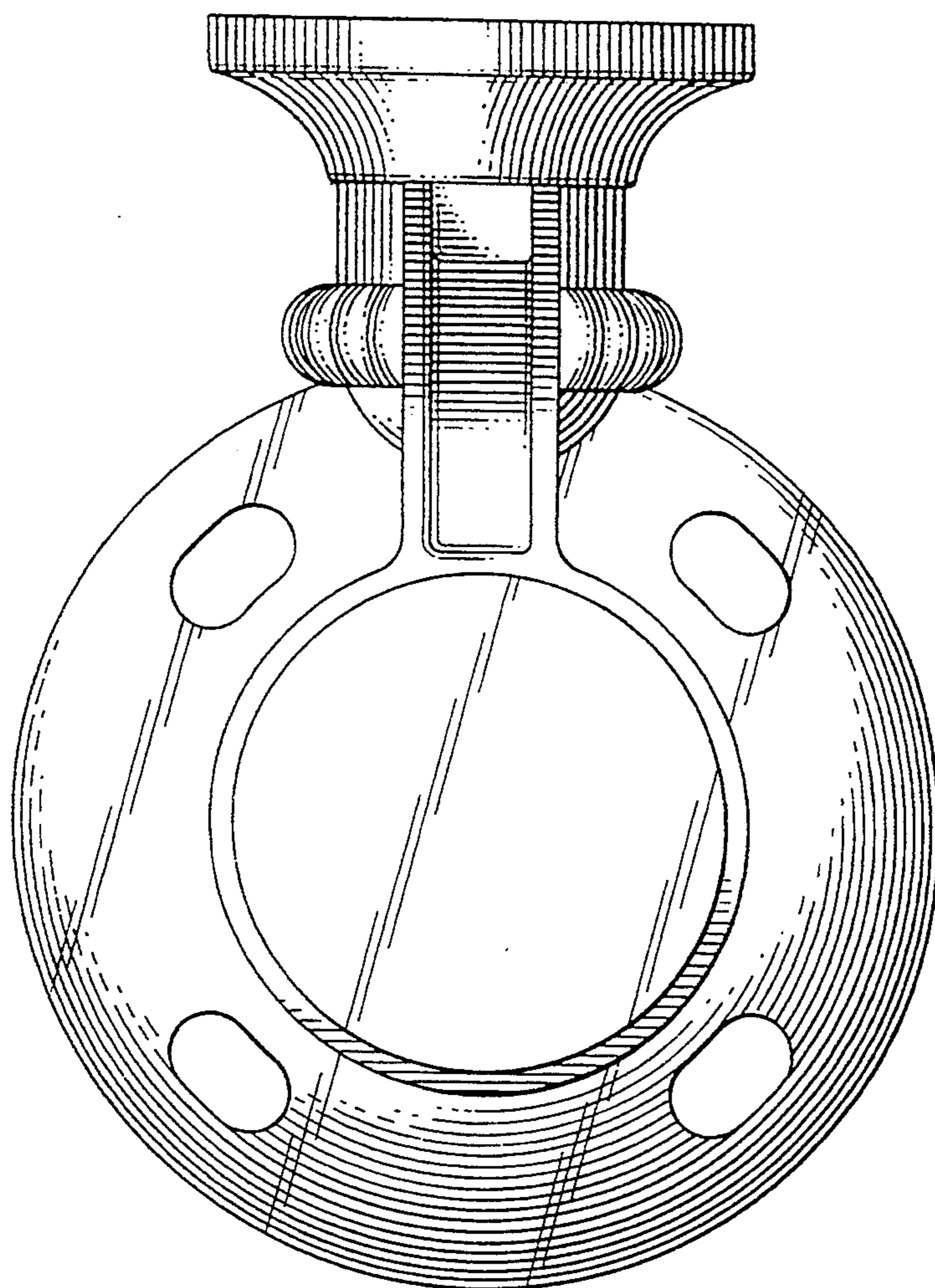


*Fig. 6*





*Fig. 7*



*Fig. 8*

