



US00D356631S

United States Patent [19]

[11] Patent Number: **Des. 356,631**

Kolada

[45] Date of Patent: **** Mar. 21, 1995**

[54] **SPOUT**

D. 349,757 8/1994 Altman D23/255

[75] Inventor: **Paul P. Kolada**, Columbus, Ohio

Primary Examiner—A. Hugo Word

[73] Assignee: **American Standard Inc.**, Piscataway, N.J.

Assistant Examiner—Eric Watterson

Attorney, Agent, or Firm—Elaine Brenner Robinson; Ann M. Knab

[**] Term: **14 Years**

[57] **CLAIM**

[21] Appl. No.: **20,739**

The ornamental design for a spout, as shown and described.

[22] Filed: **Mar. 31, 1994**

[52] U.S. Cl. **D23/255**

DESCRIPTION

[58] Field of Search D23/255, 256, 257, 258; 4/675, 676, 677, 678; 137/801

FIG. 1 is a perspective view of the spout showing my new design;

FIG. 2 is a top plan view thereof;

FIG. 3 is a front elevational view thereof;

FIG. 4 is a right side view thereof, the left side being a mirror image of the right side;

FIG. 5 is a rear elevational view thereof; and,

FIG. 6 is a bottom plan view thereof.

[56] **References Cited**

U.S. PATENT DOCUMENTS

- D. 278,270 4/1985 Niemann D23/255
- D. 299,161 12/1988 Frottini D23/255
- D. 329,688 9/1992 Yost D23/255

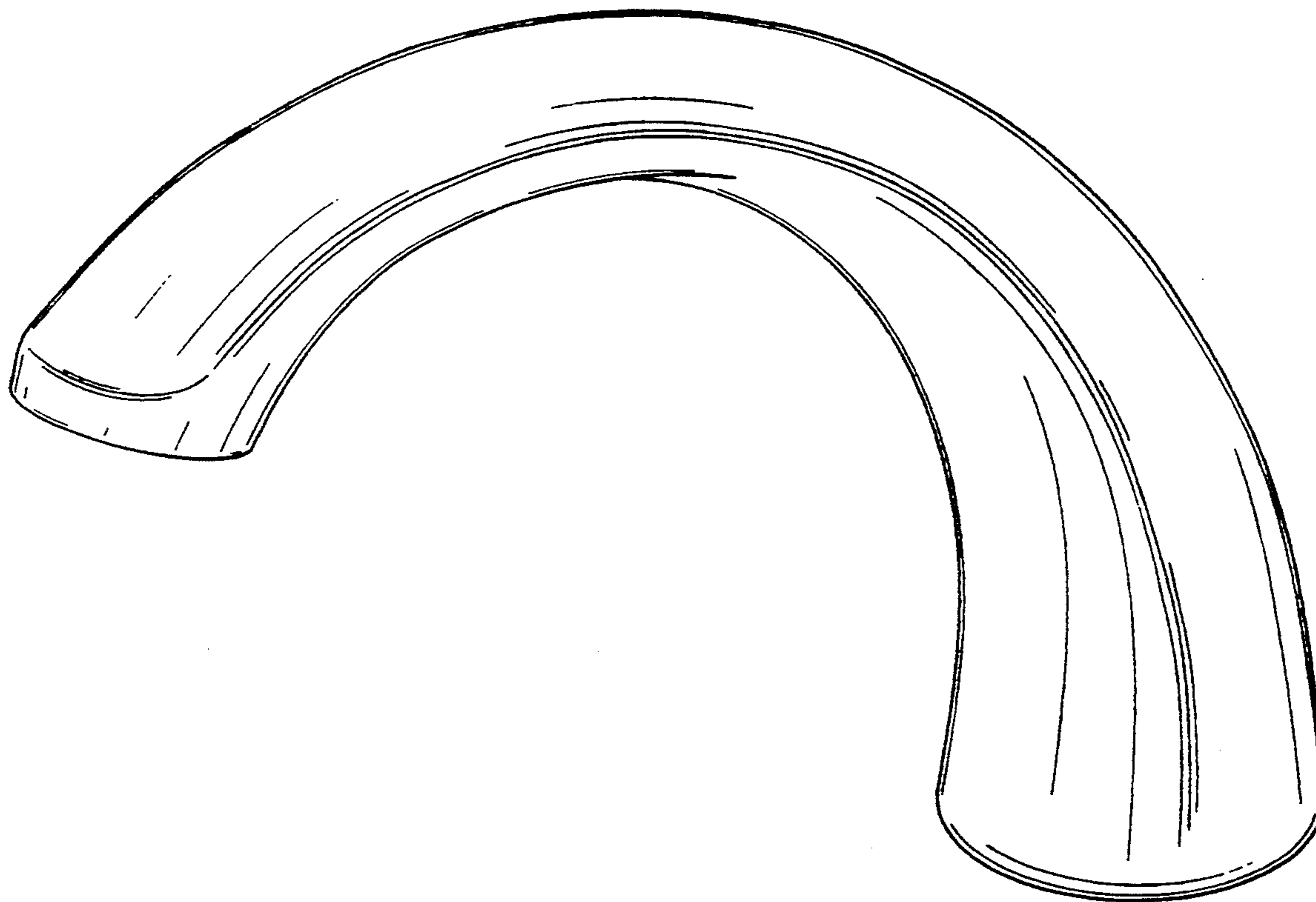

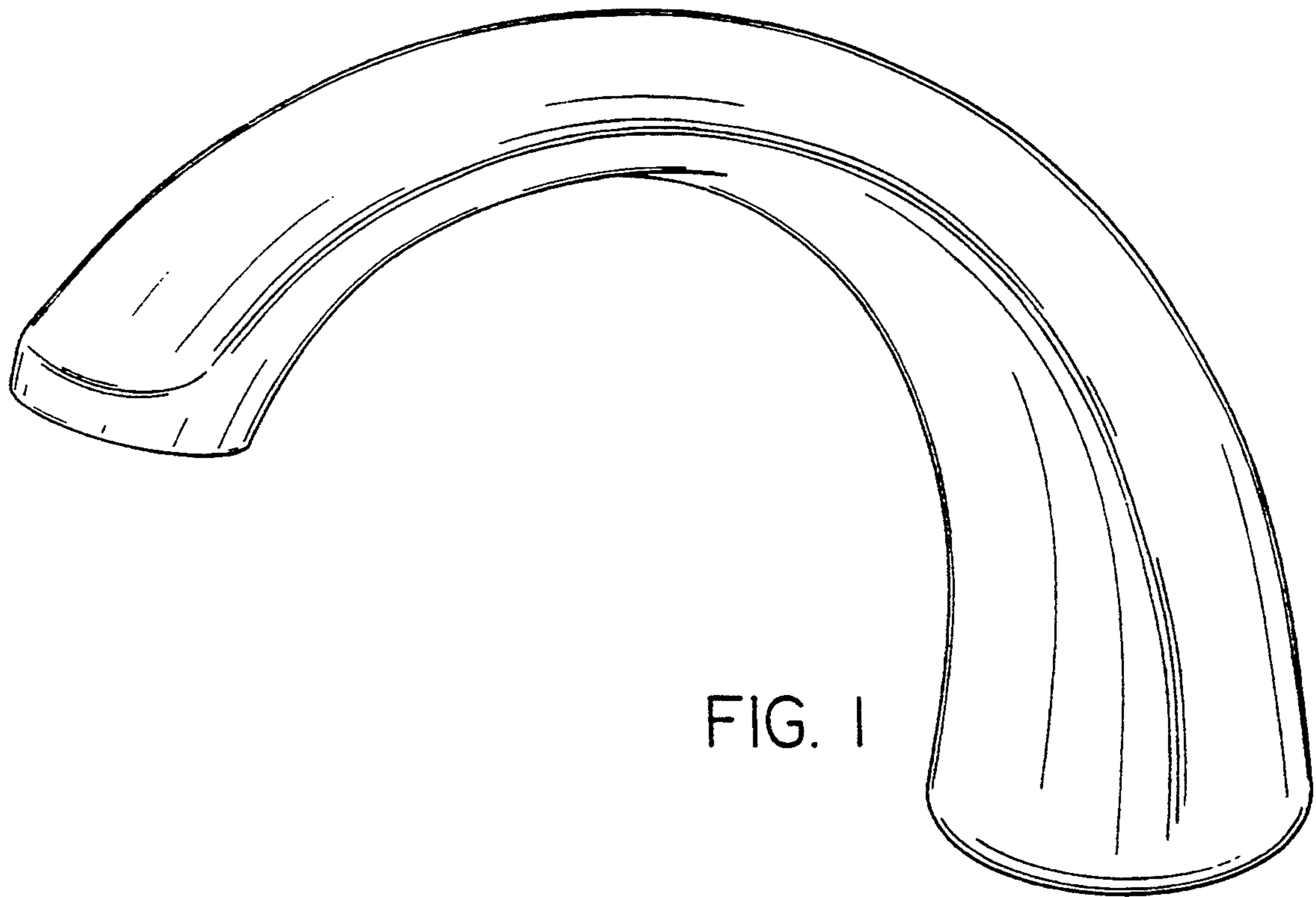

FIG. 1

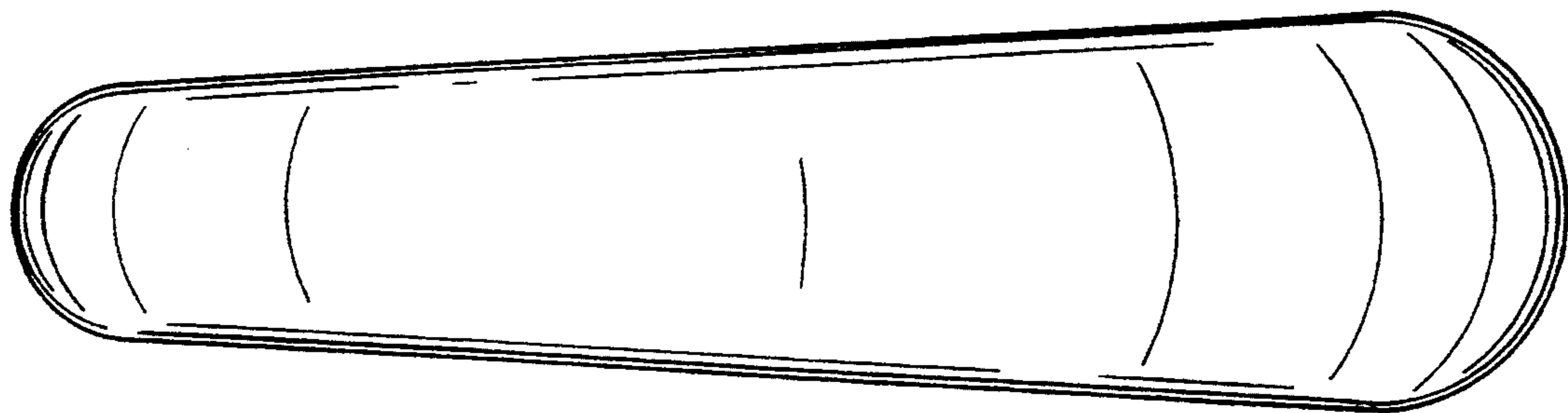

FIG. 2

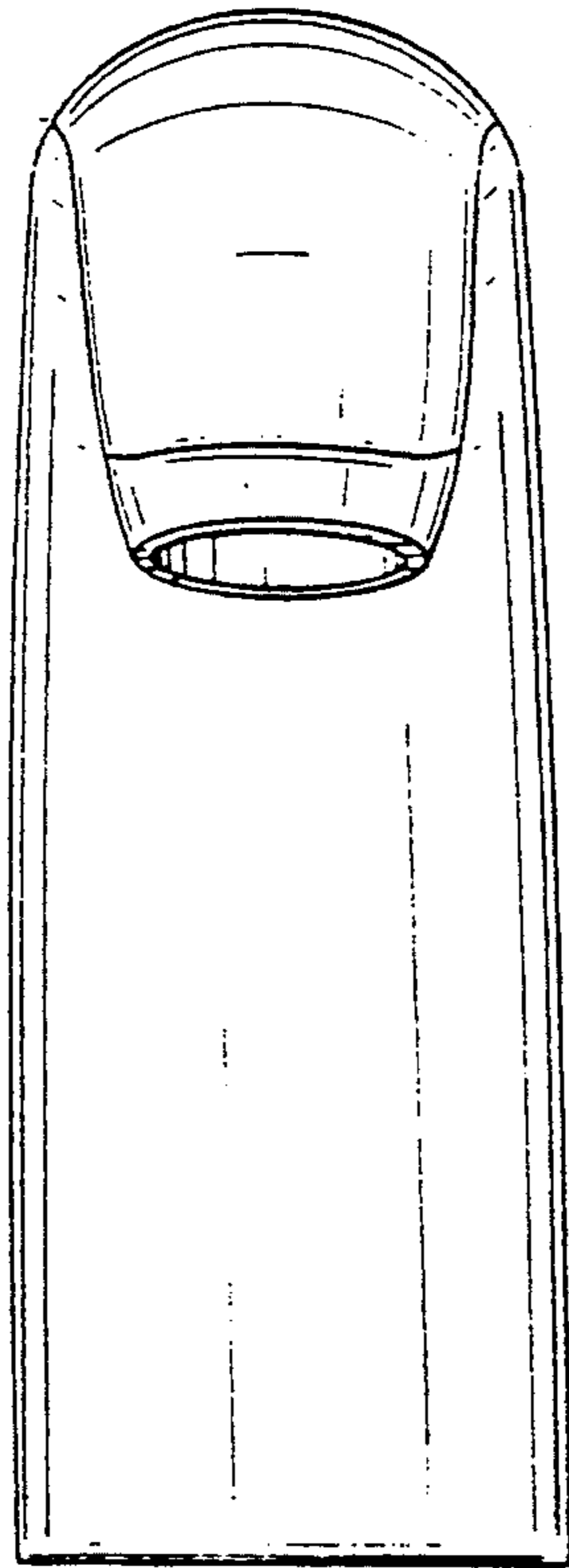

FIG. 3

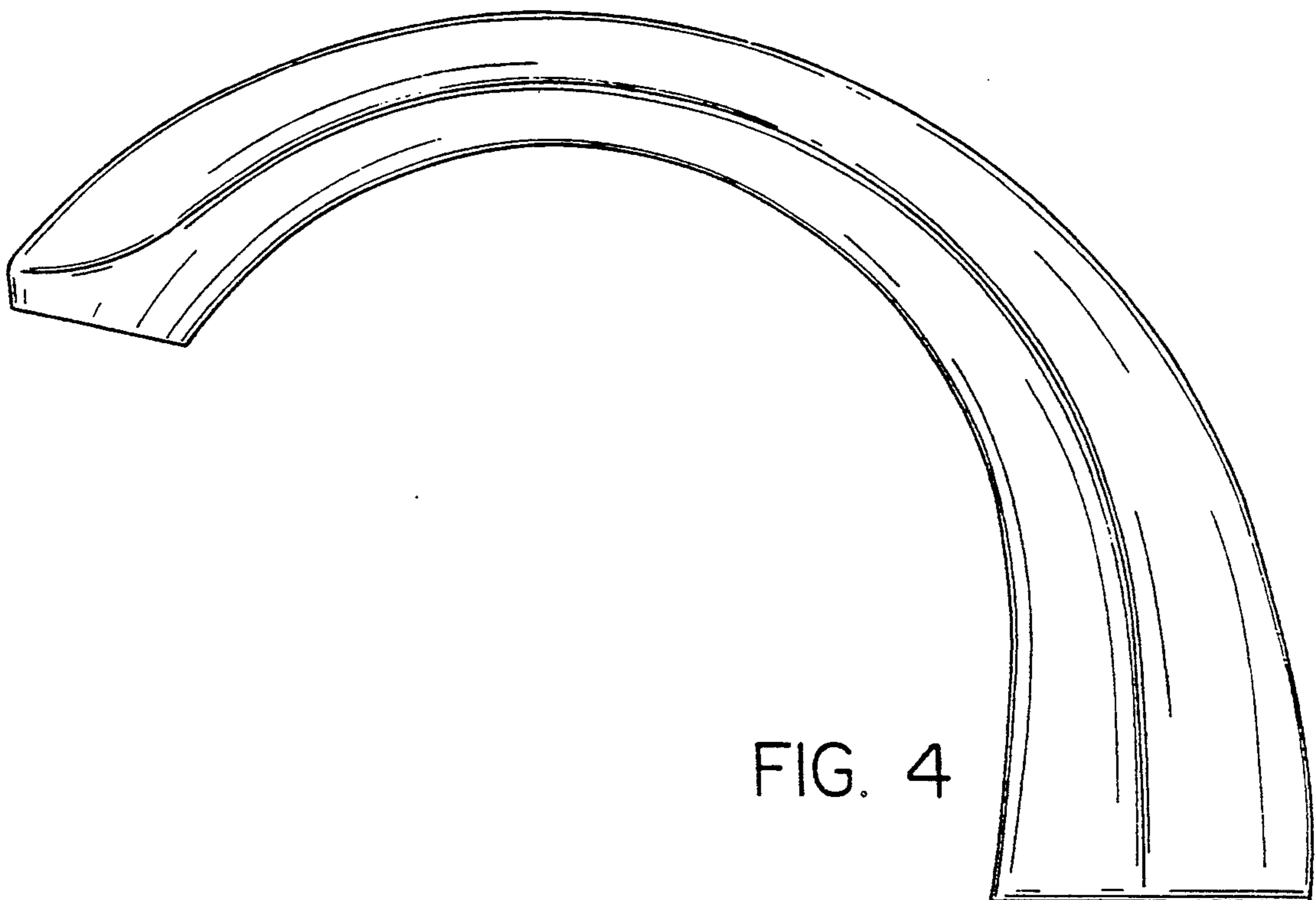

FIG. 4

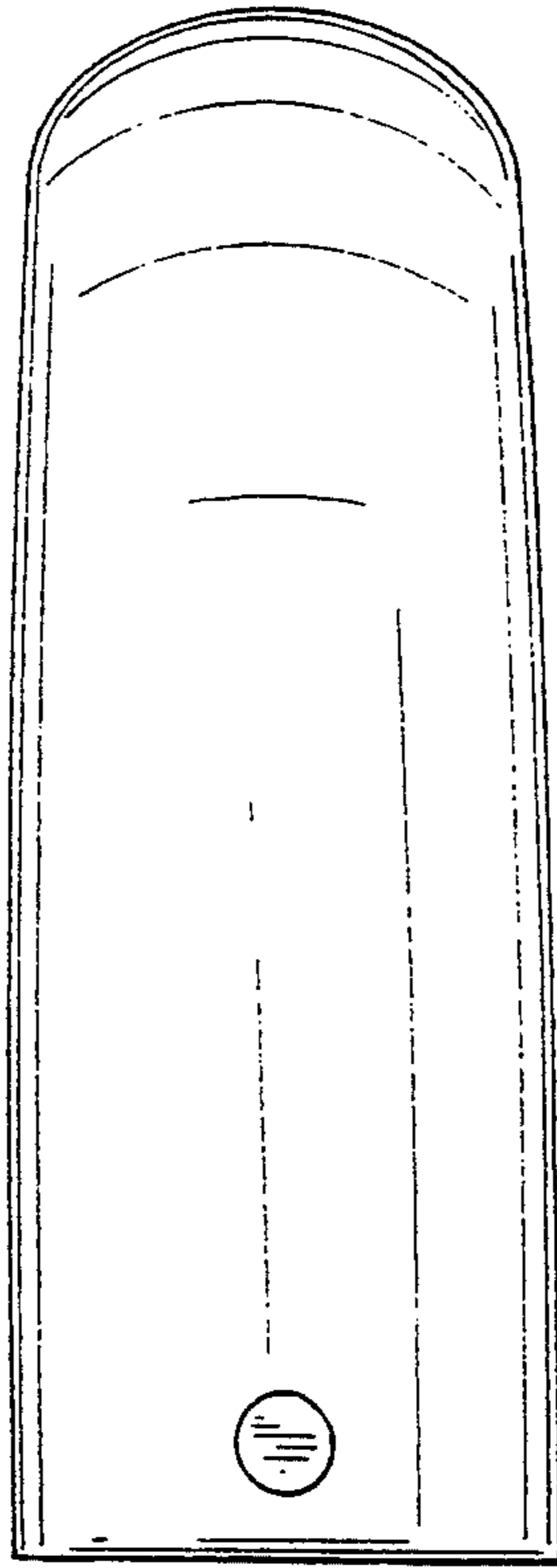

FIG. 5

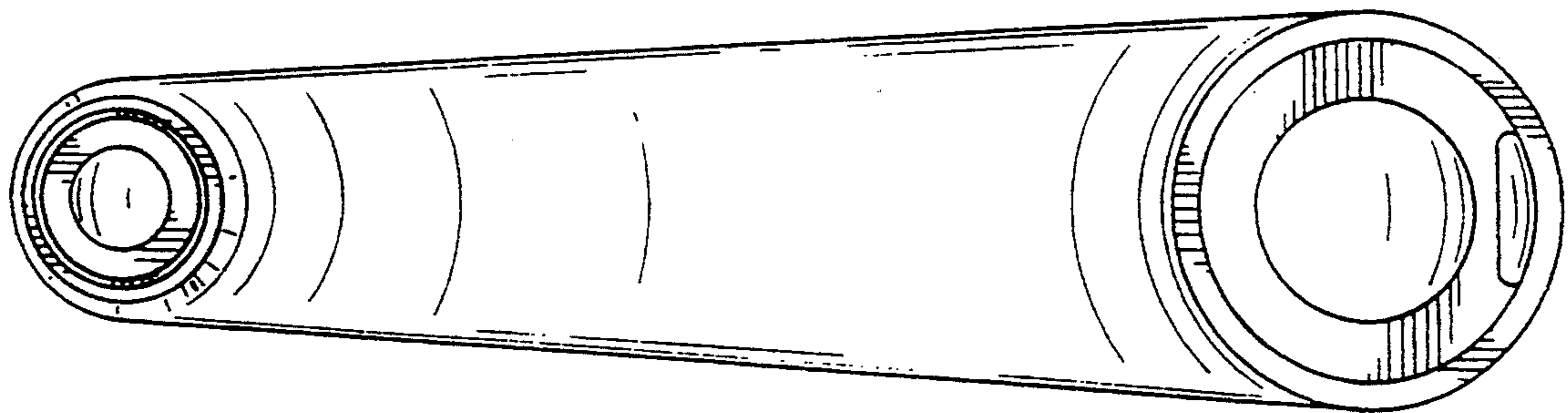

FIG. 6