



US00D356575S

United States Patent [19]

[11] Patent Number: **Des. 356,575**

Makino

[45] Date of Patent: **** Mar. 21, 1995**

[54] PUMP

[56] References Cited

[75] Inventor: **Michio Makino**, Funabashi, Japan

U.S. PATENT DOCUMENTS

2,364,686	12/1944	Balisteri et al.	D15/8
4,472,113	9/1984	Rogen	417/321
4,702,830	10/1987	Makino et al.	210/77
4,752,421	6/1988	Makino et al.	261/120
4,911,838	3/1990	Tanaka	210/242.2

[73] Assignee: **Kaiyo Kogyo Kabushiki Kaisha**,
Tokyo, Japan

Primary Examiner—Ralf T. Seifert
Attorney, Agent, or Firm—Wenderoth, Lind & Ponack

[**] Term: **14 Years**

[57] CLAIM

[21] Appl. No.: **12,883**

The ornamental design for a pump, as shown and described.

[22] Filed: **Sep. 14, 1993**

DESCRIPTION

[30] Foreign Application Priority Data

Apr. 22, 1993	[JP]	Japan	5-11975
[52]	U.S. Cl.		D15/8
[58]	Field of Search	D23/231, 232, 213, 207; 417/234, 258, 321, 410 B, 415-416, 426, 535-537; 152/415-416, 426; D30/106; D15/7-8; D22/134; 210/242.2; 261/77, 120, 123	

FIG. 1 is a front elevational view of a pump showing my new design, the rear elevational view being a mirror image thereof;
 FIG. 2 is a top plan view thereof;
 FIG. 3 is a bottom plan view thereof;
 FIG. 4 is a right side elevational view thereof;
 FIG. 5 is a left side elevational view thereof;
 FIG. 6 is a cross-sectional view thereof taken along line 6-6 in FIG. 1; and,
 FIG. 7 is a perspective view thereof.

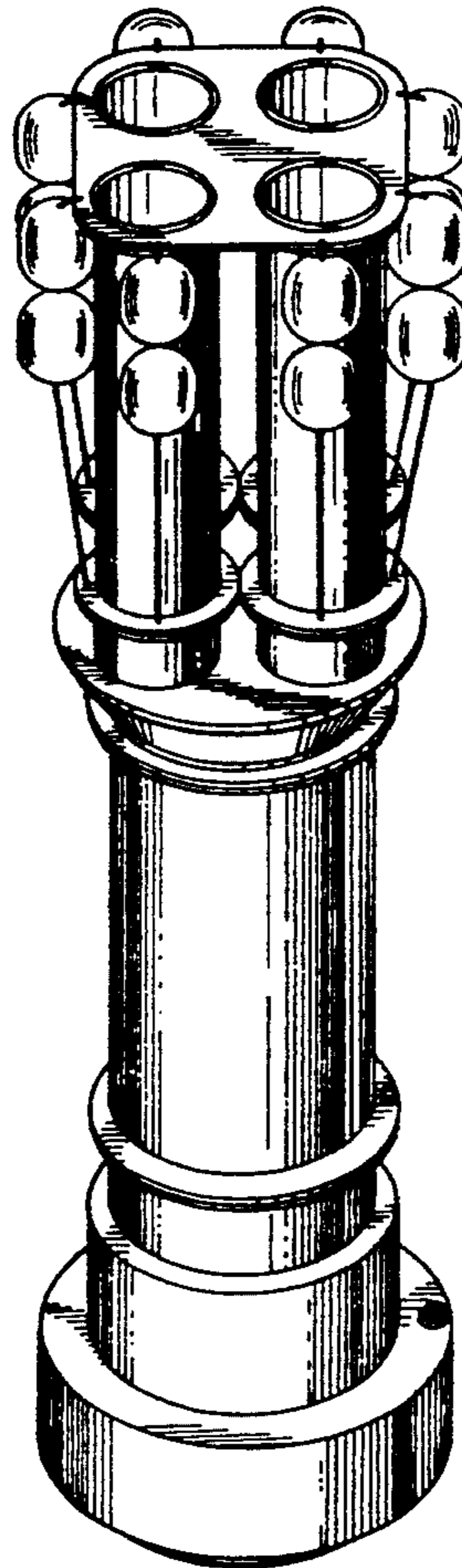

FIG. 1

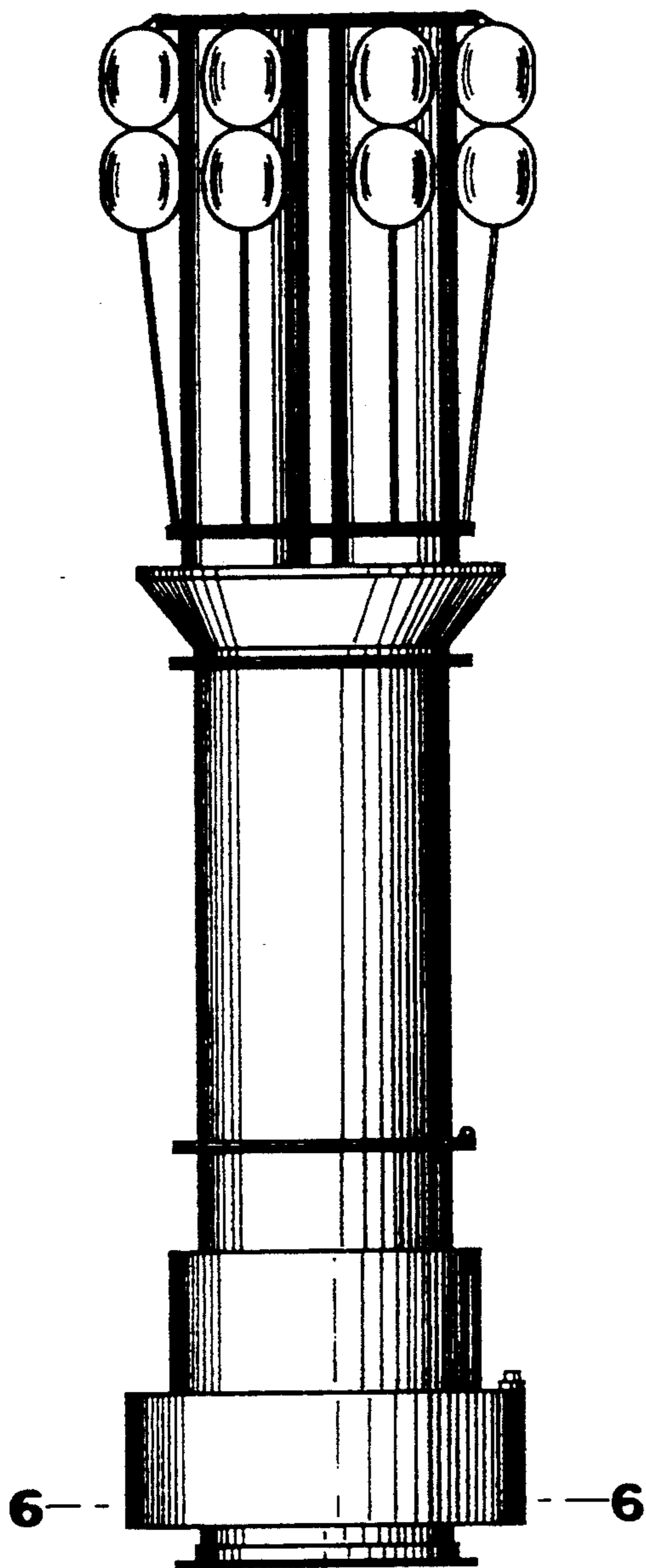

FIG. 2

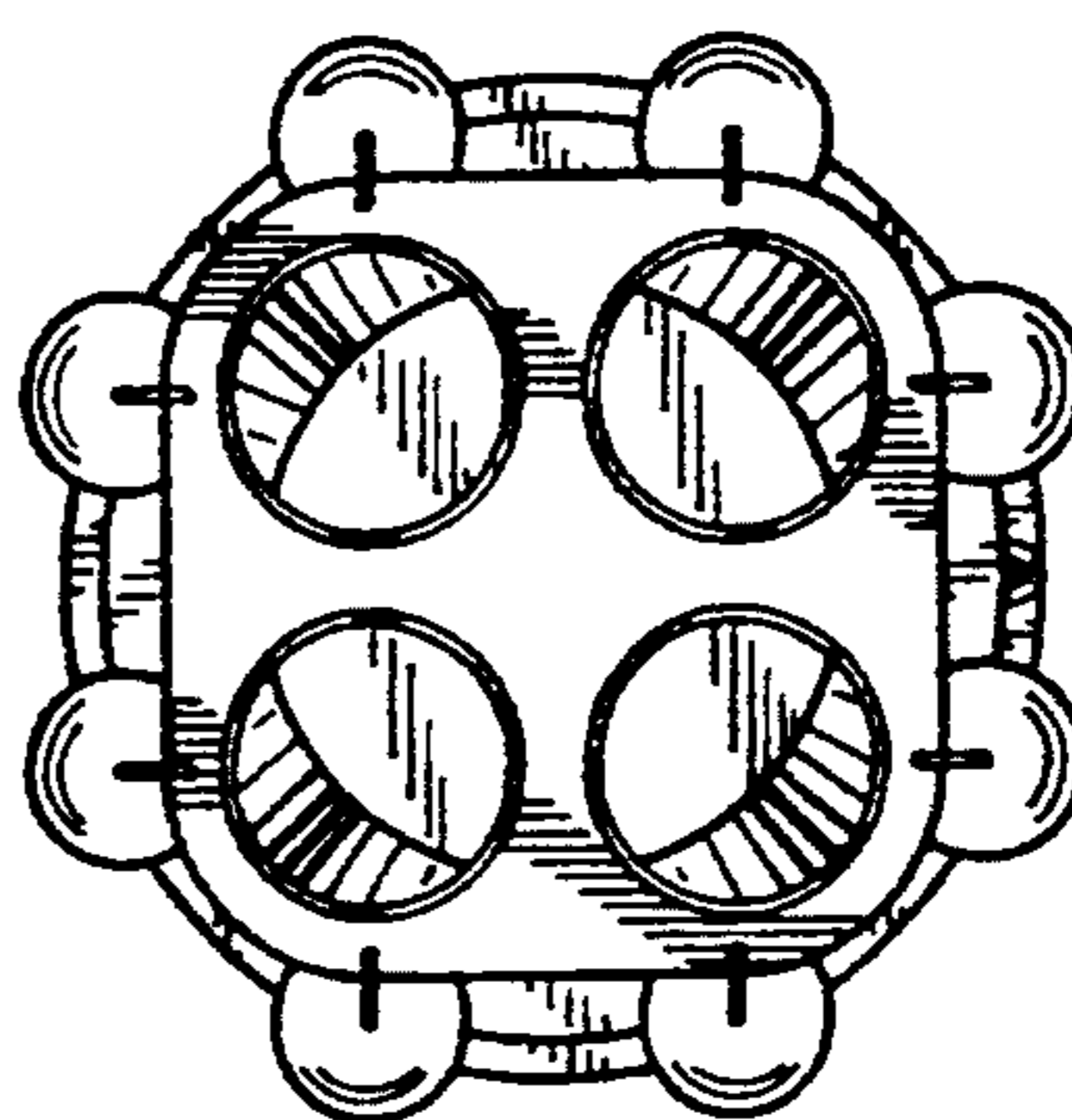

FIG. 3

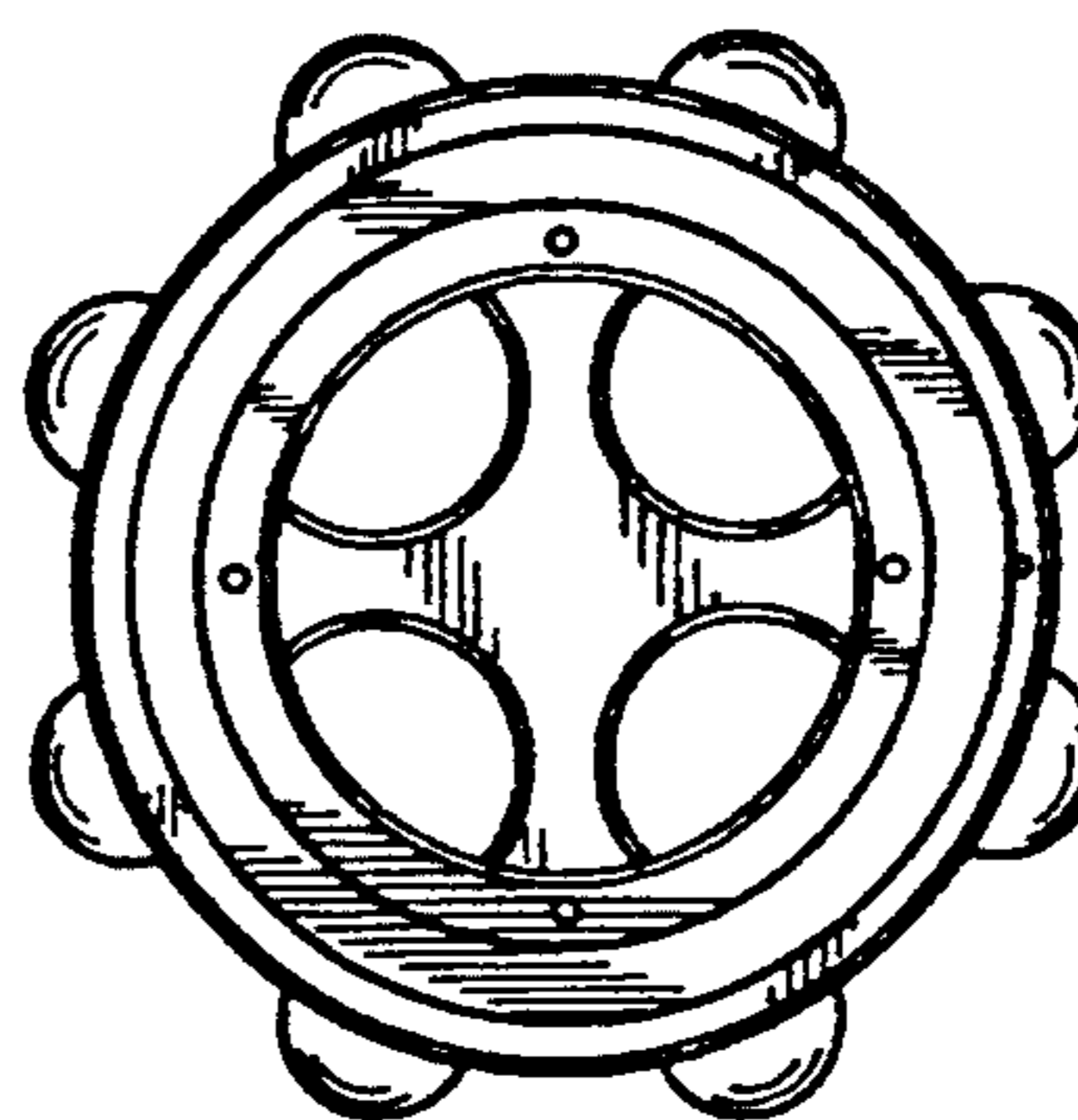

FIG. 4

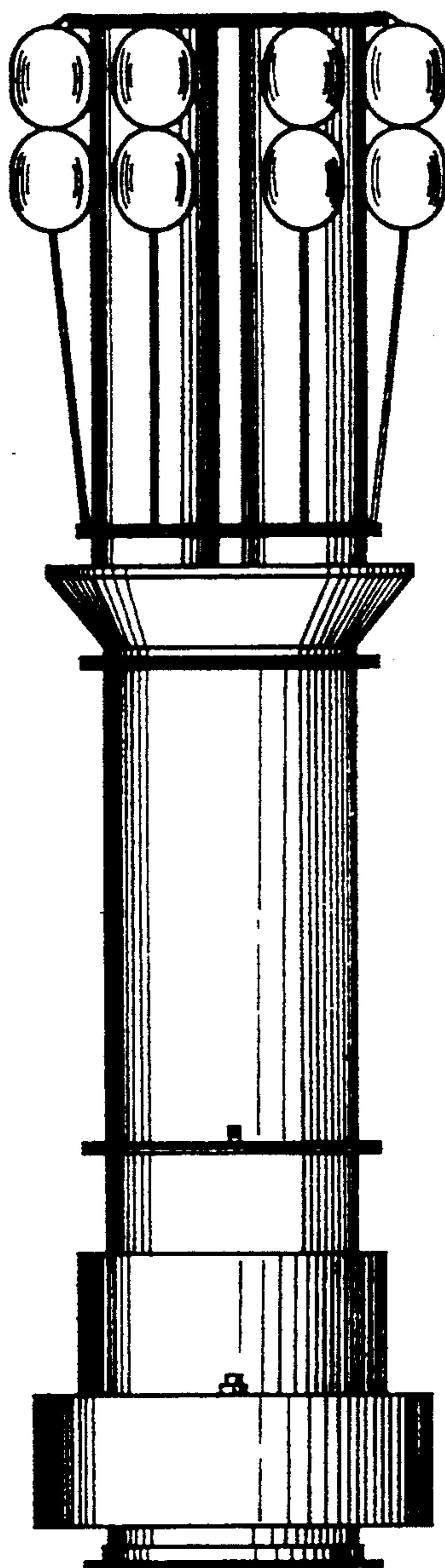

FIG. 5

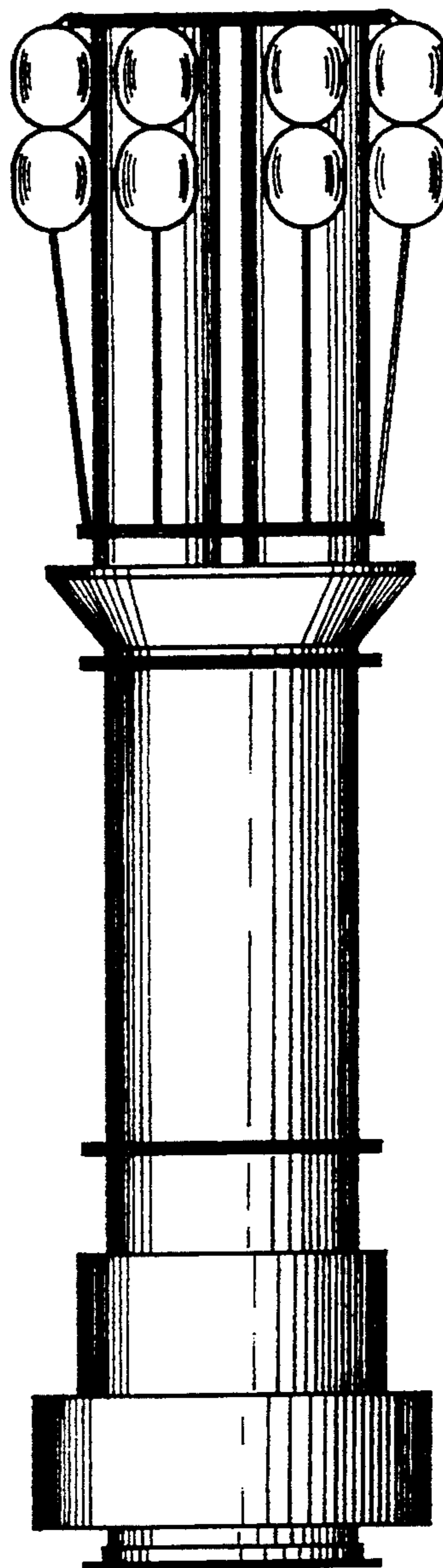

FIG. 6

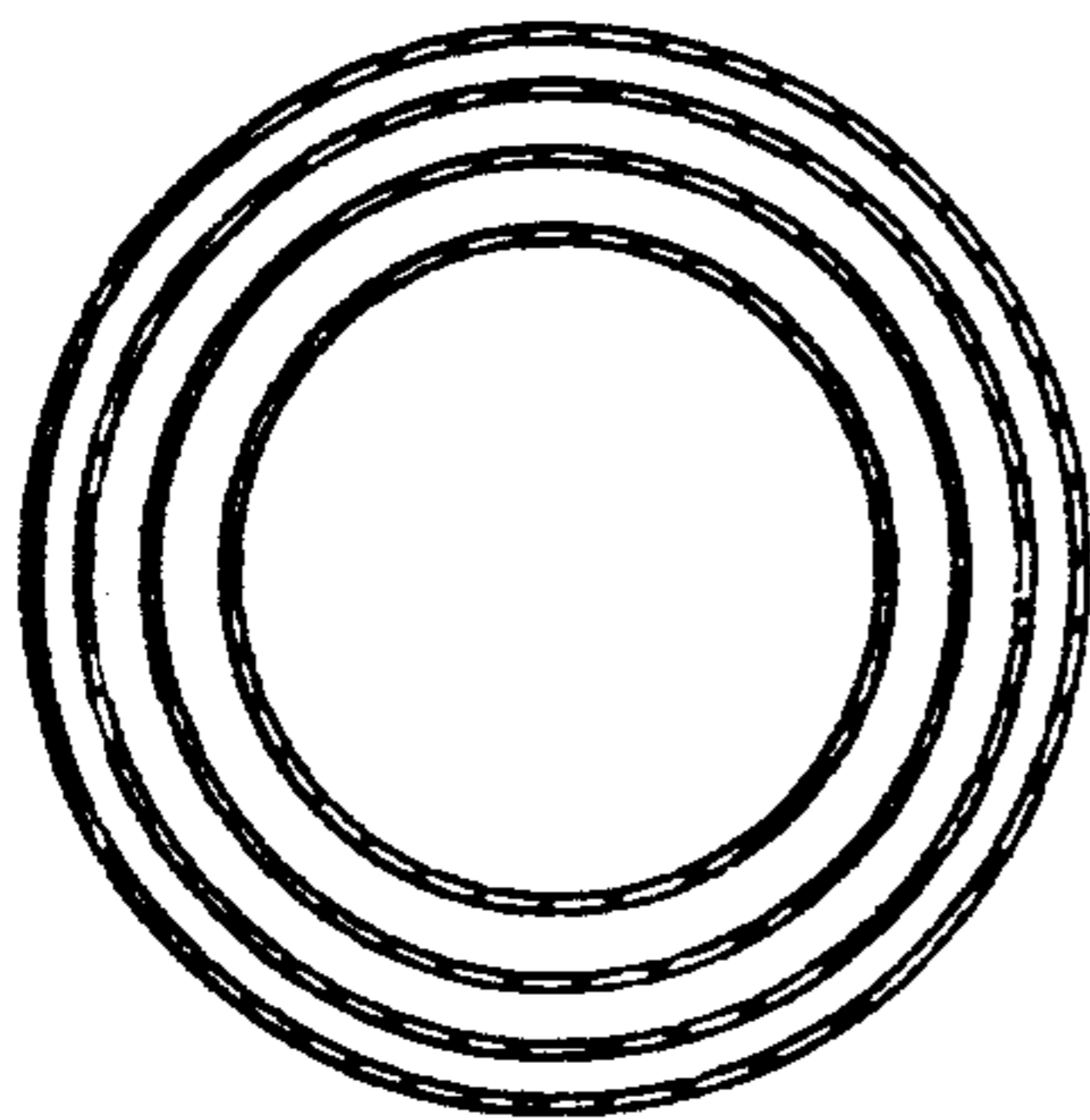

FIG. 7

