



US00D356458S

United States Patent [19]

Wobschall

[11] Patent Number: **Des. 356,458**

[45] Date of Patent: **** Mar. 21, 1995**

[54] **FABRIC SOFTENER SHEET HOLDER**

4,919,350 4/1990 Miller 242/55.2

[76] Inventor: **Marlene A. Wobschall**, P.O. Box 662,
Squaw Valley, Calif. 93675

FOREIGN PATENT DOCUMENTS

1121870 8/1956 France 248/905

[**] Term: **14 Years**

Primary Examiner—Brian N. Vinson

[21] Appl. No.: **22,842**

[57] CLAIM

[22] Filed: **May 13, 1994**

The ornamental design for a fabric softener sheet holder, as shown and described.

Related U.S. Application Data

[63] Continuation of Ser. No. 694,045, May 1, 1991, abandoned.

[52] U.S. Cl. **D6/518**

[58] Field of Search D6/518-523;
242/55.2, 55.54; 248/905

DESCRIPTION

FIG. 1 is a front elevational view of a fabric softener sheet holder showing my new design;
FIG. 2 is a rear elevational view thereof;
FIG. 3 is a left side elevational view thereof;
FIG. 4 is a right side elevational view thereof;
FIG. 5 is a top plan view thereof;
FIG. 6 is a bottom plan view thereof; and,
FIG. 7 is a top, front, and right side perspective view thereof, the broken-line disclosure of a roll of fabric softener sheets being for illustrative purposes only and forming no part of the claimed design.

[56] References Cited

U.S. PATENT DOCUMENTS

D. 314,484 2/1991 Richter et al. D6/522
4,634,067 1/1987 White 242/55.2

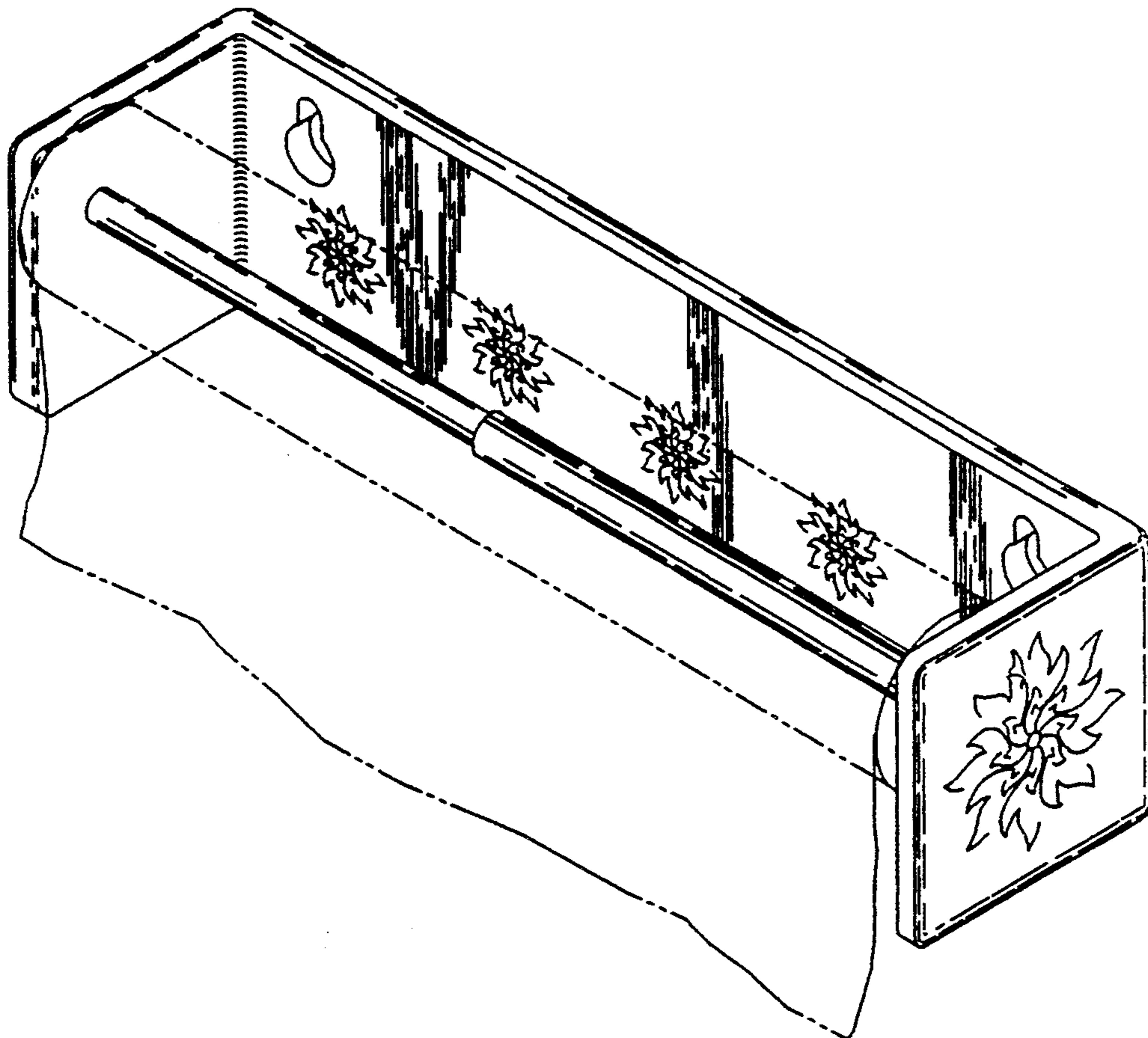

FIG. 1

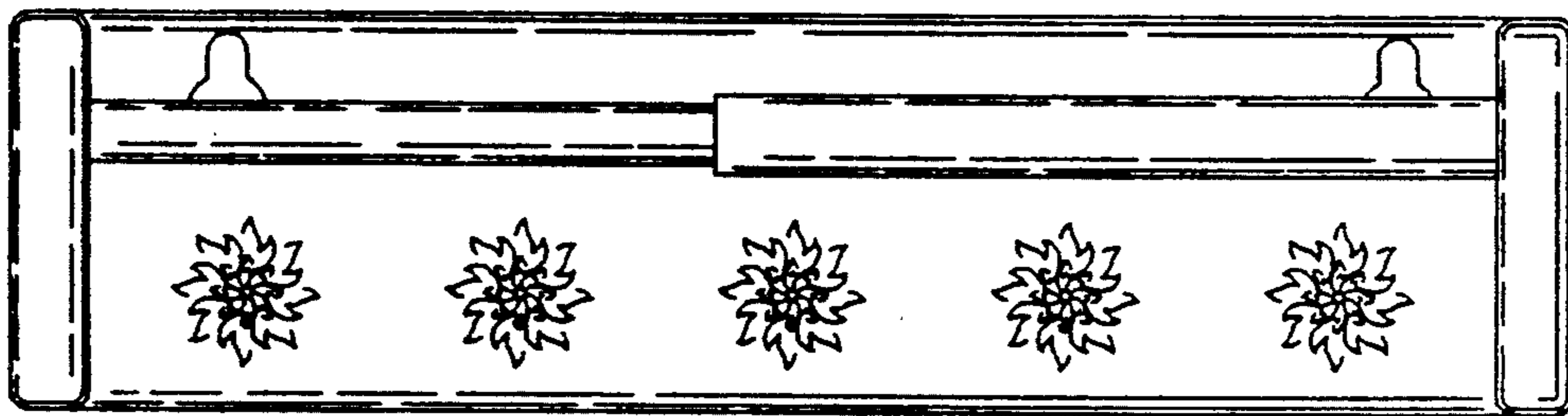

FIG. 2

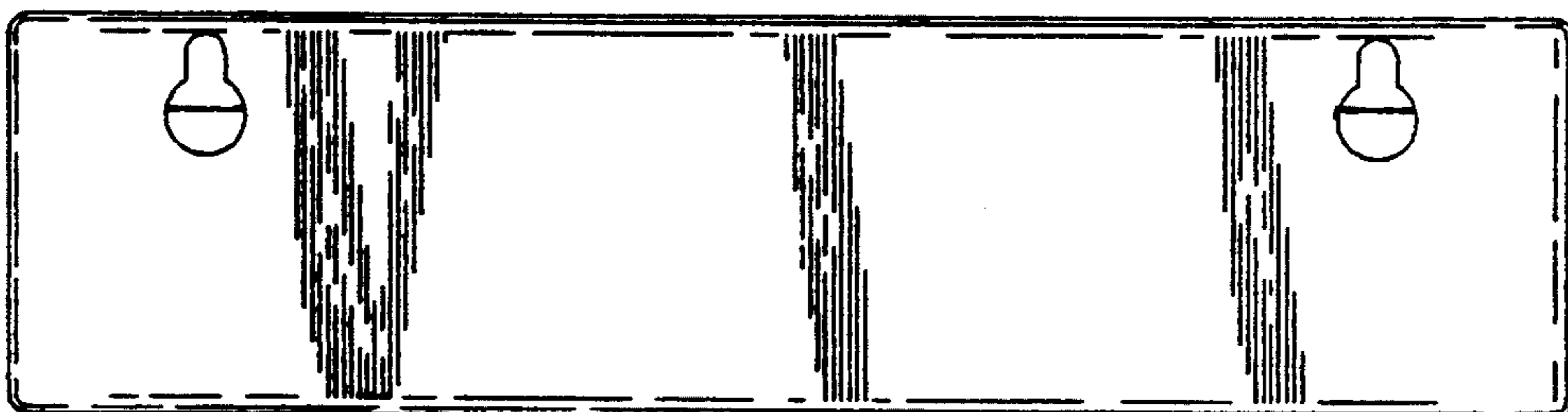

FIG. 3

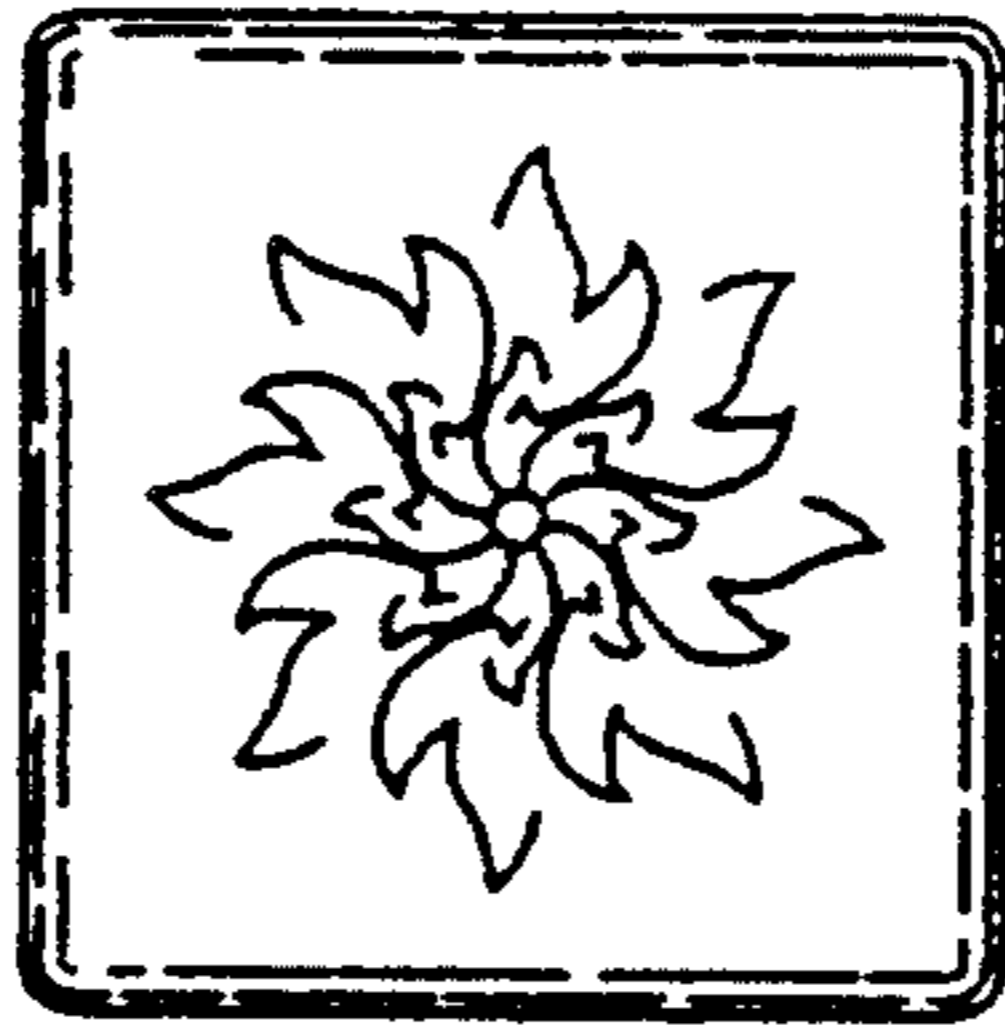

FIG. 4

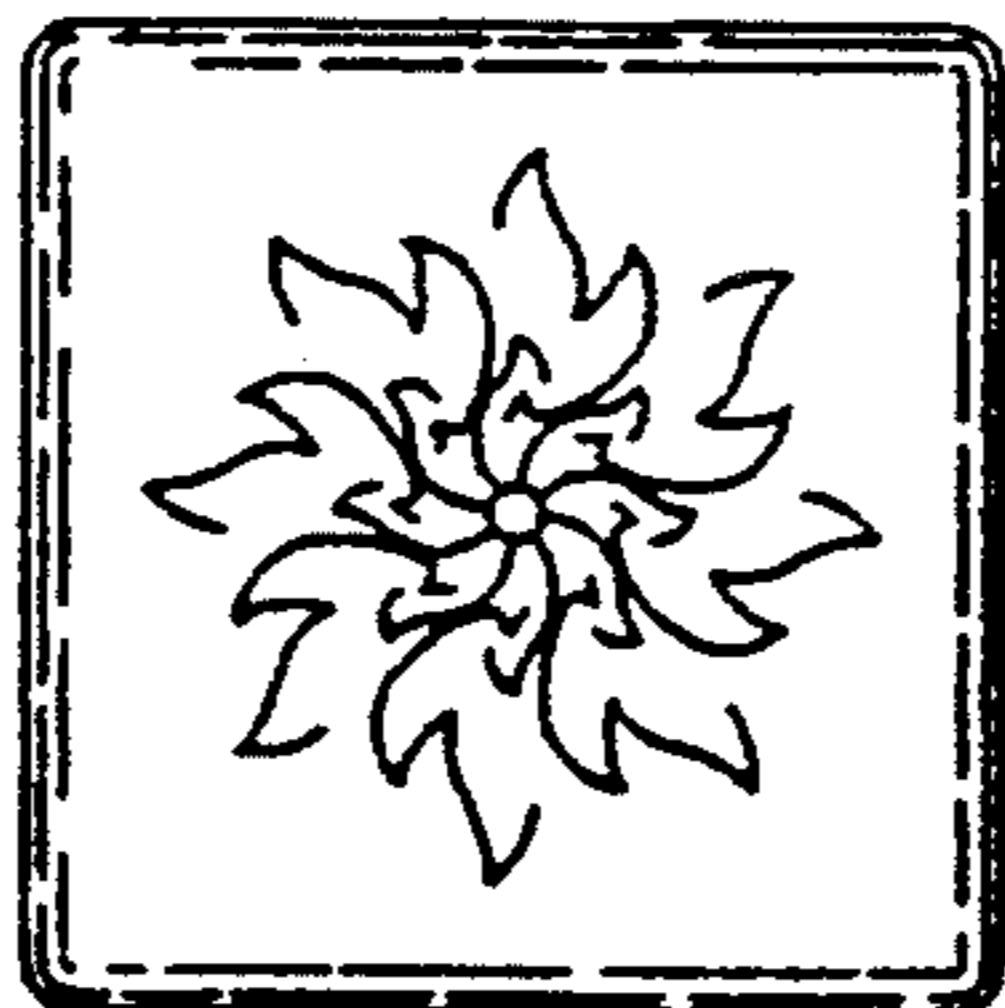

FIG. 5

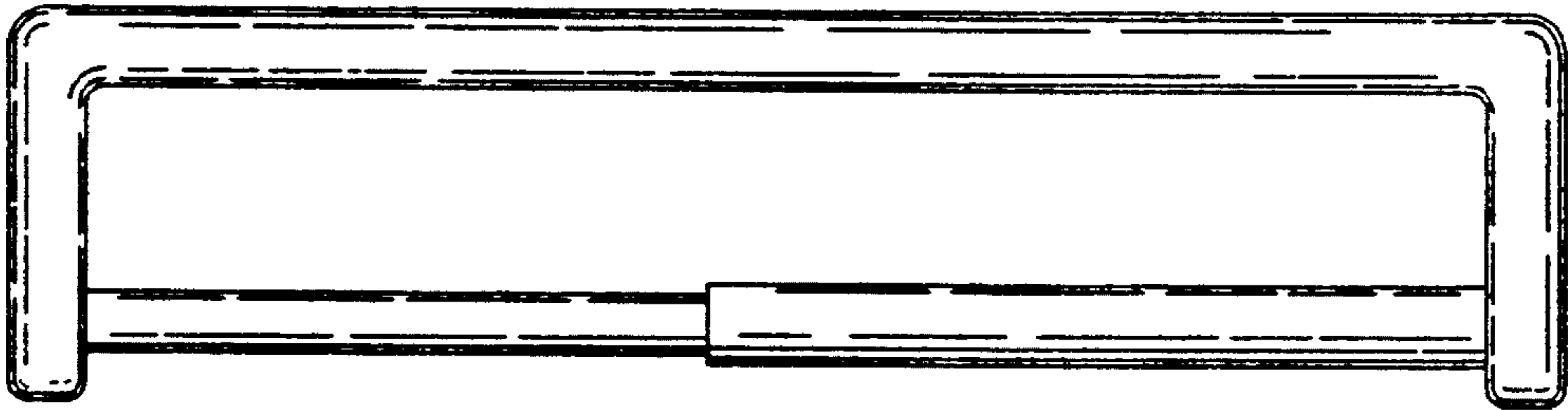

FIG. 6

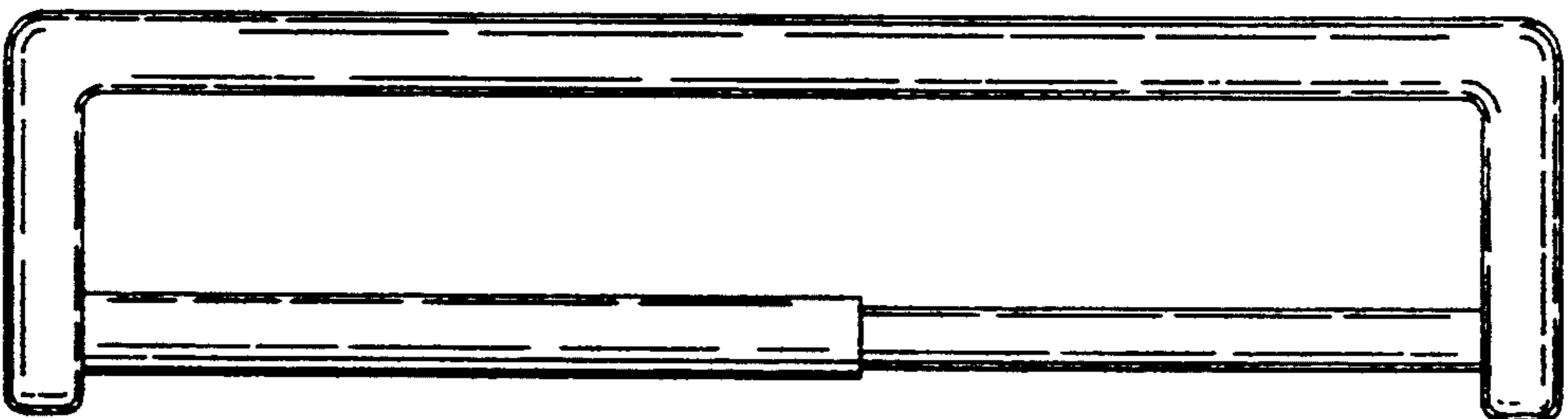

FIG. 7

