



US00D356437S

# United States Patent [19]

[11] Patent Number: **Des. 356,437**

Marshall

[45] Date of Patent: **\*\* Mar. 21, 1995**

[54] **ADJUSTABLE SANDLE**

[76] Inventor: **Gregory Marshall, 3177 Camino Aleta, San Diego, Calif. 92154**

[\*\*] Term: **14 Years**

[21] Appl. No.: **13,371**

[22] Filed: **Sep. 23, 1993**

[52] U.S. Cl. .... **D2/916**

[58] Field of Search ..... **D2/896, 909, 914-918, D2/946; 36/7.5, 7.6, 7.7, 11.5, 135, 7.1 R**

3,913,243 10/1975 Arnold et al. .... 36/135  
 4,281,466 8/1981 Malone ..... 36/7.1 R  
 4,713,895 12/1987 Vallieres ..... 36/7.1 R  
 5,329,704 7/1994 Martin, Jr. .... 36/7.6 X

*Primary Examiner*—Louis S. Zarfaz  
*Attorney, Agent, or Firm*—Terry M. Gernstein

### [57] CLAIM

The ornamental design for an adjustable sandle, as shown and described.

### DESCRIPTION

FIG. 1 is a front, top and side perspective view of the Adjustable Sandle showing my new design; FIG. 2 is a front elevational view thereof; FIG. 3 is a rear elevational view thereof; FIG. 4 is a side elevational view thereof; FIG. 5 is a side elevational view thereof; FIG. 6 is a top plan view thereof; and, FIG. 7 is a bottom plan view thereof.

[56] **References Cited**

**U.S. PATENT DOCUMENTS**

D. 345,045	3/1994	Atkins et al. ....	D2/916
2,801,478	8/1957	Gilbert .....	36/135
3,009,269	11/1961	Folk .	
3,609,888	10/1971	Rickman .	
3,722,113	3/1973	Birkenstock .....	36/11.5
3,898,750	8/1975	Epstein .....	36/7.1 R

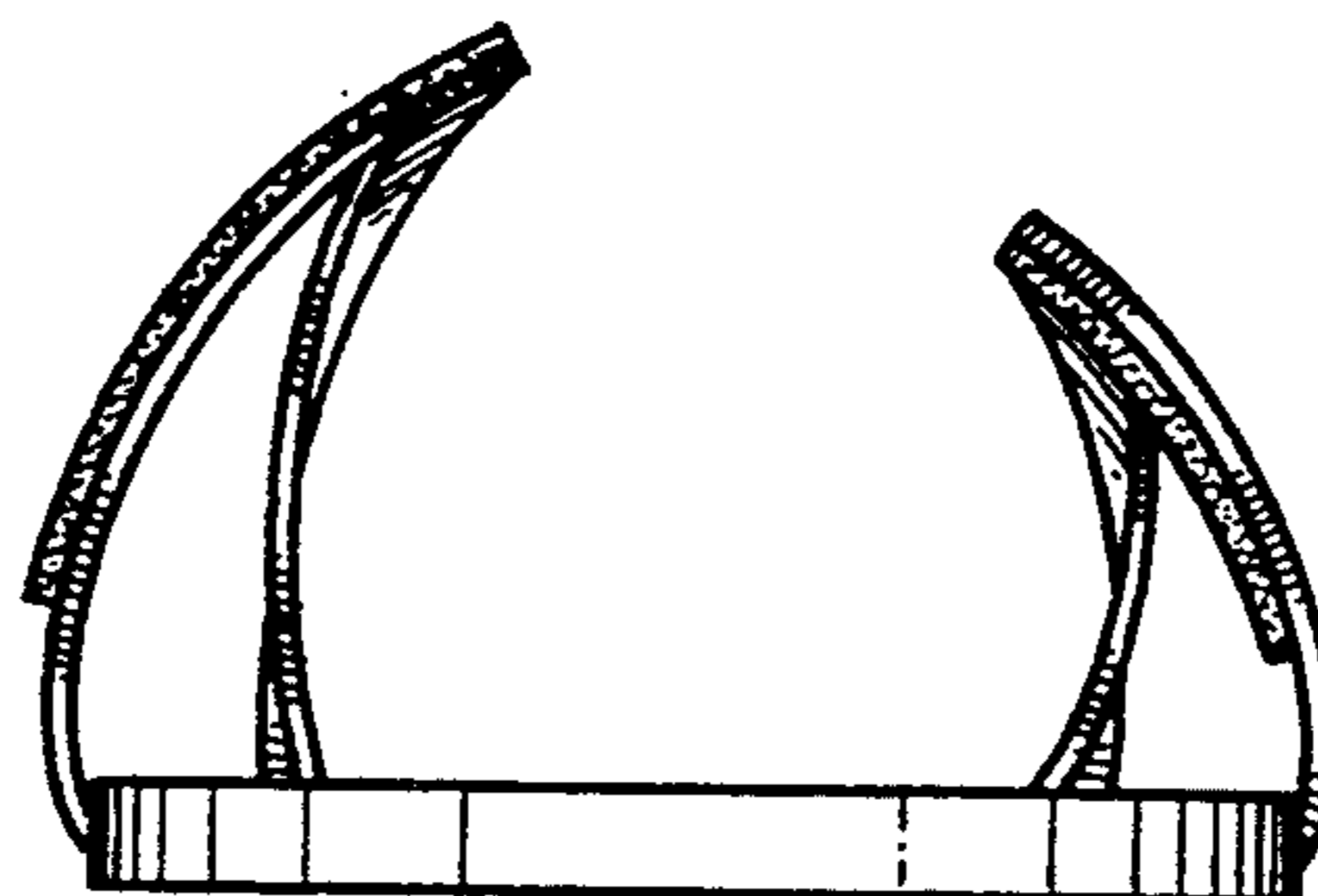
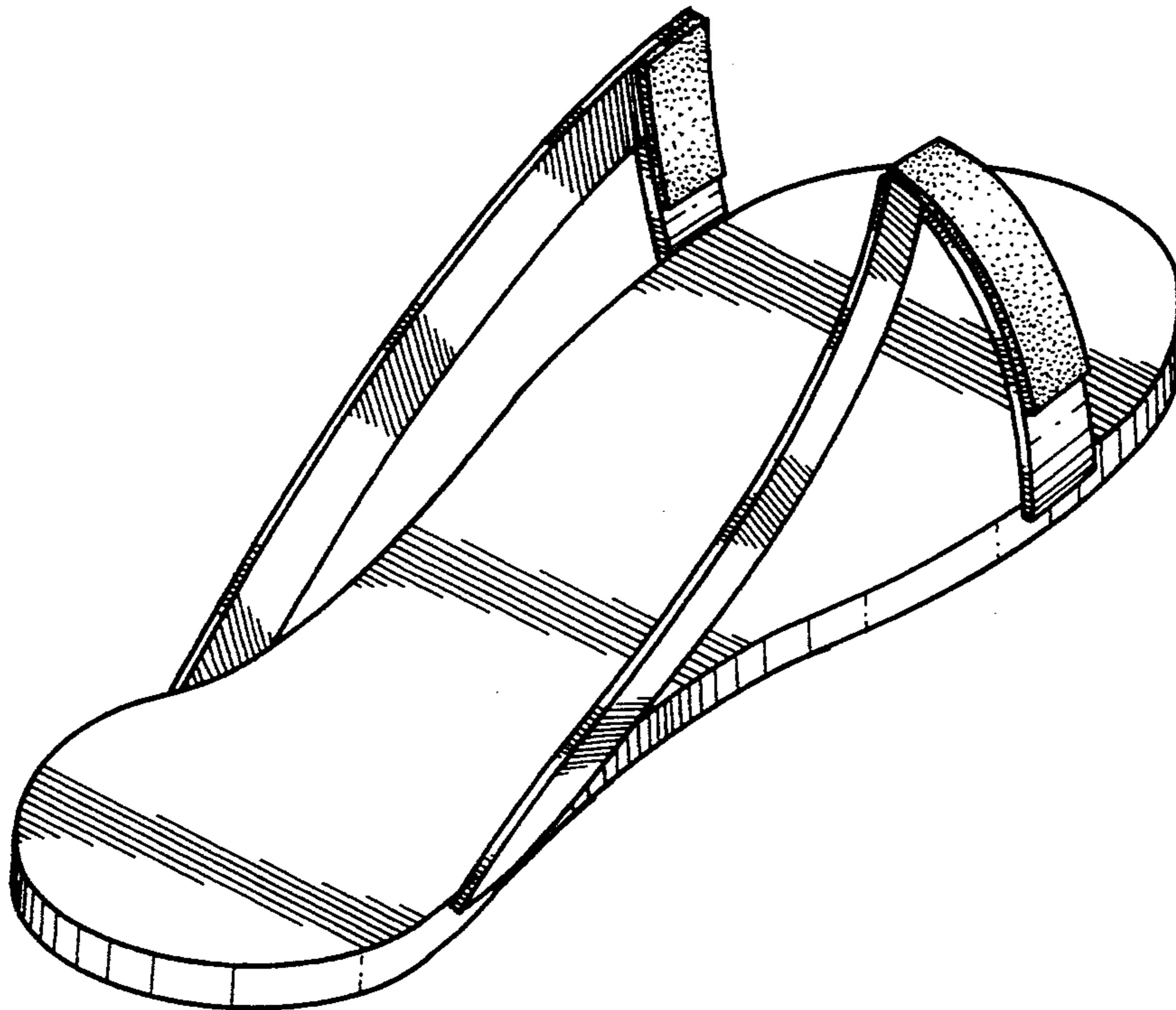

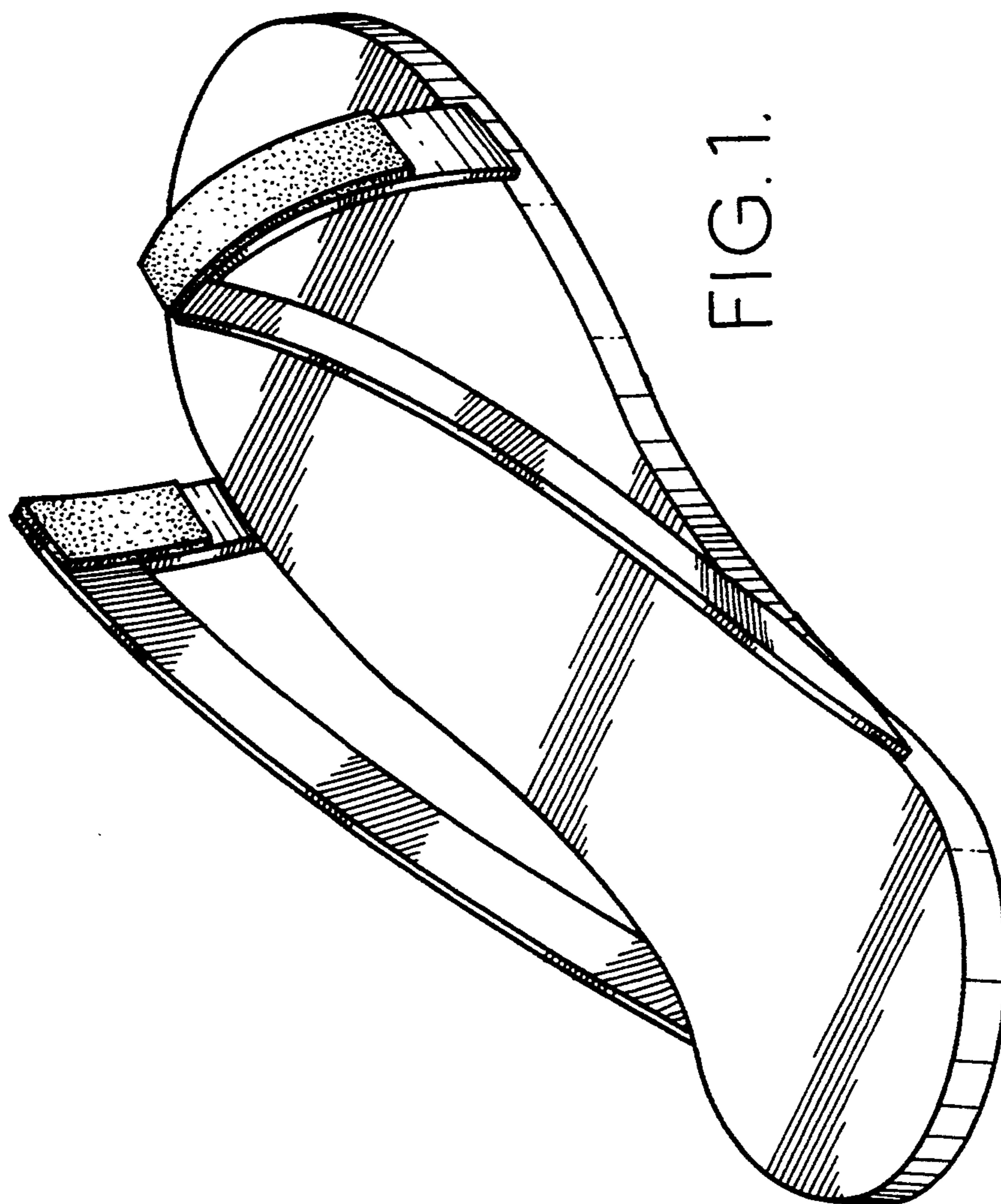

FIG. 1.

FIG. 2.

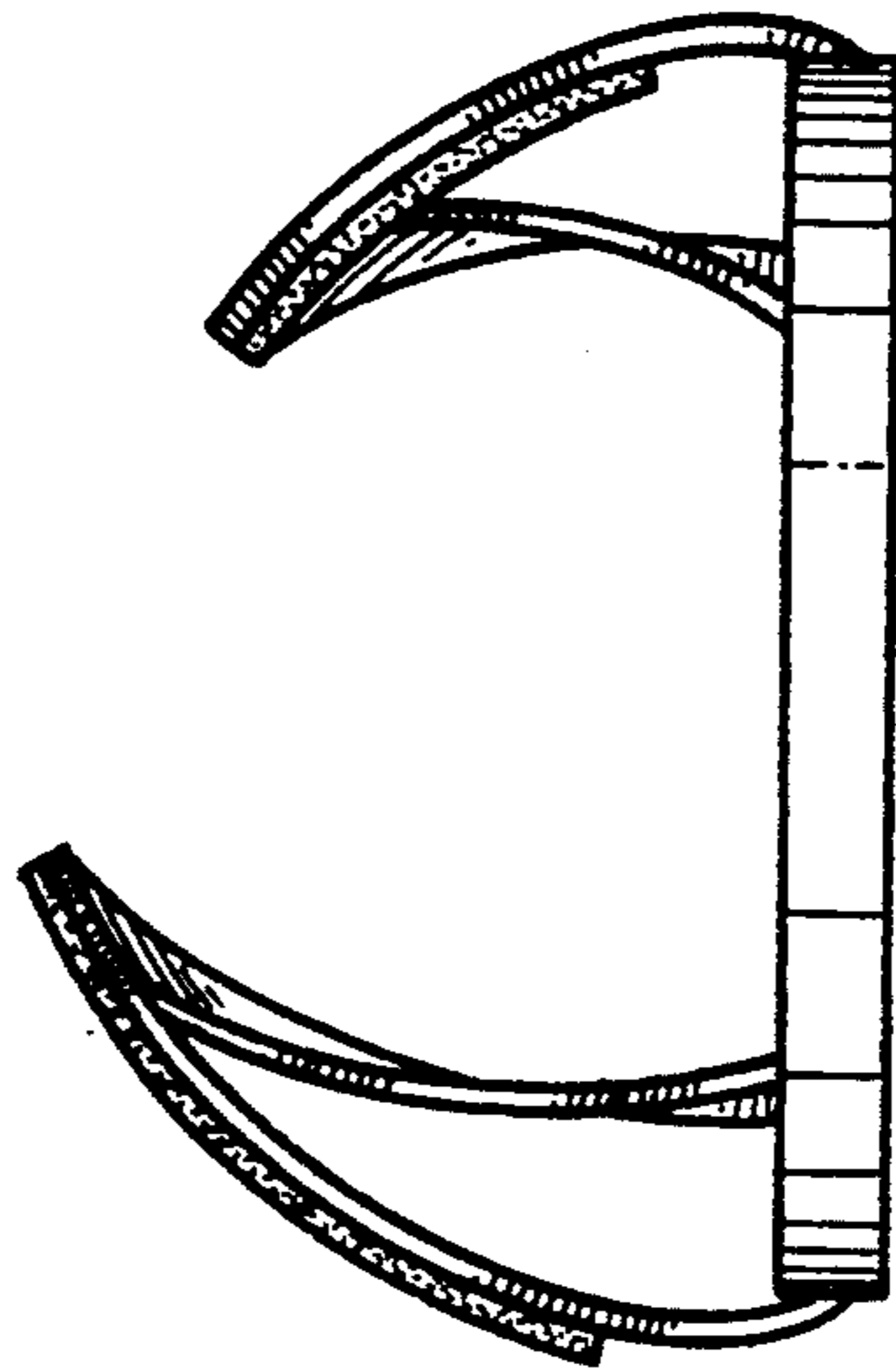

FIG.4.

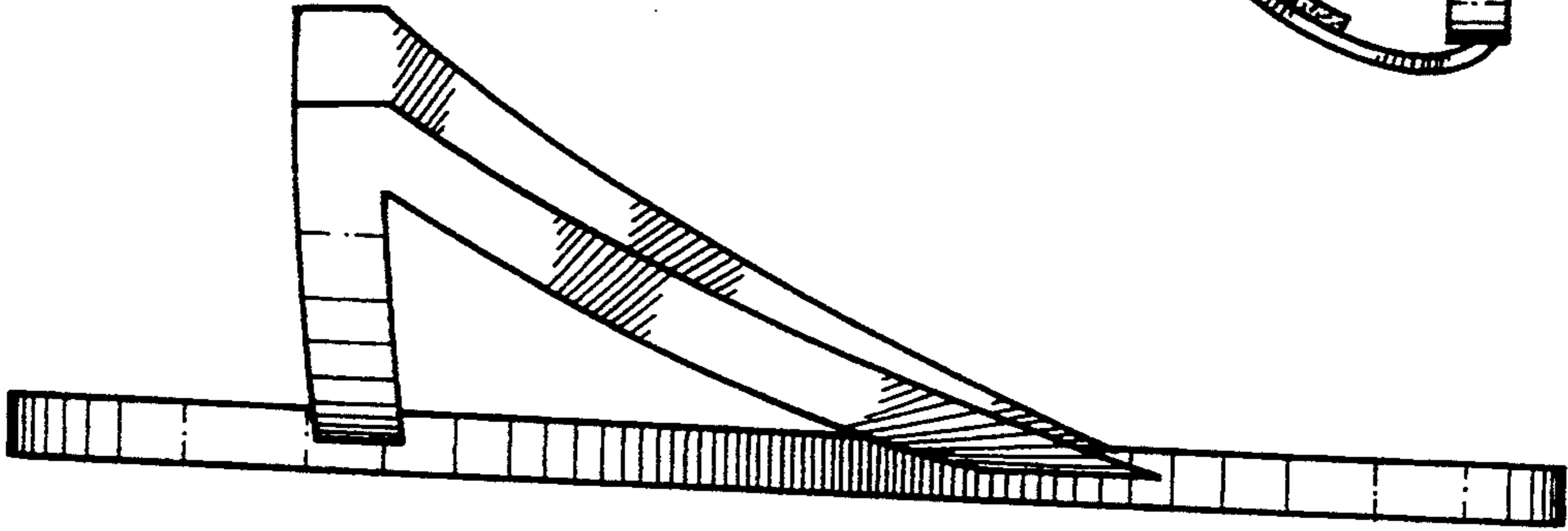

FIG.3.

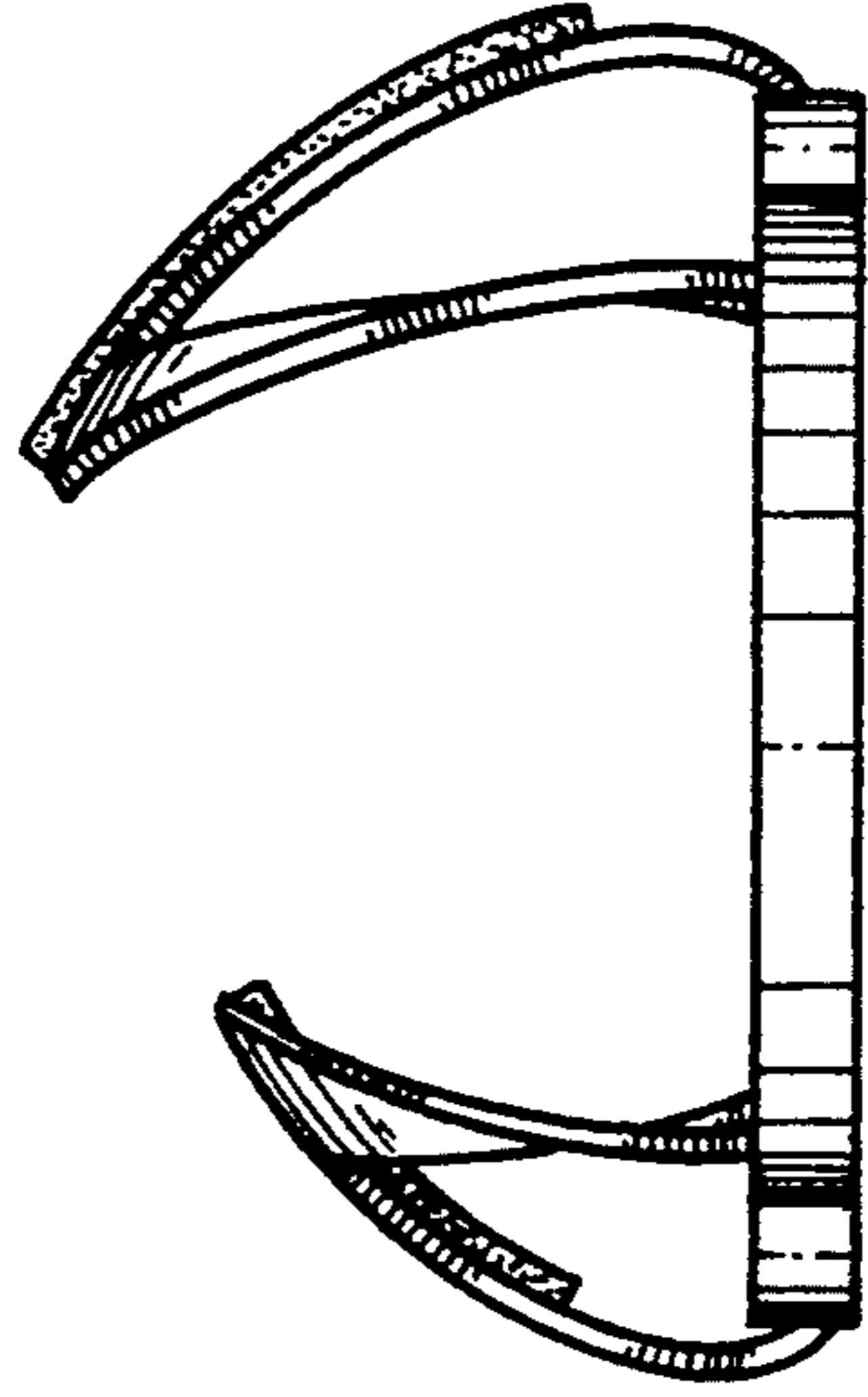
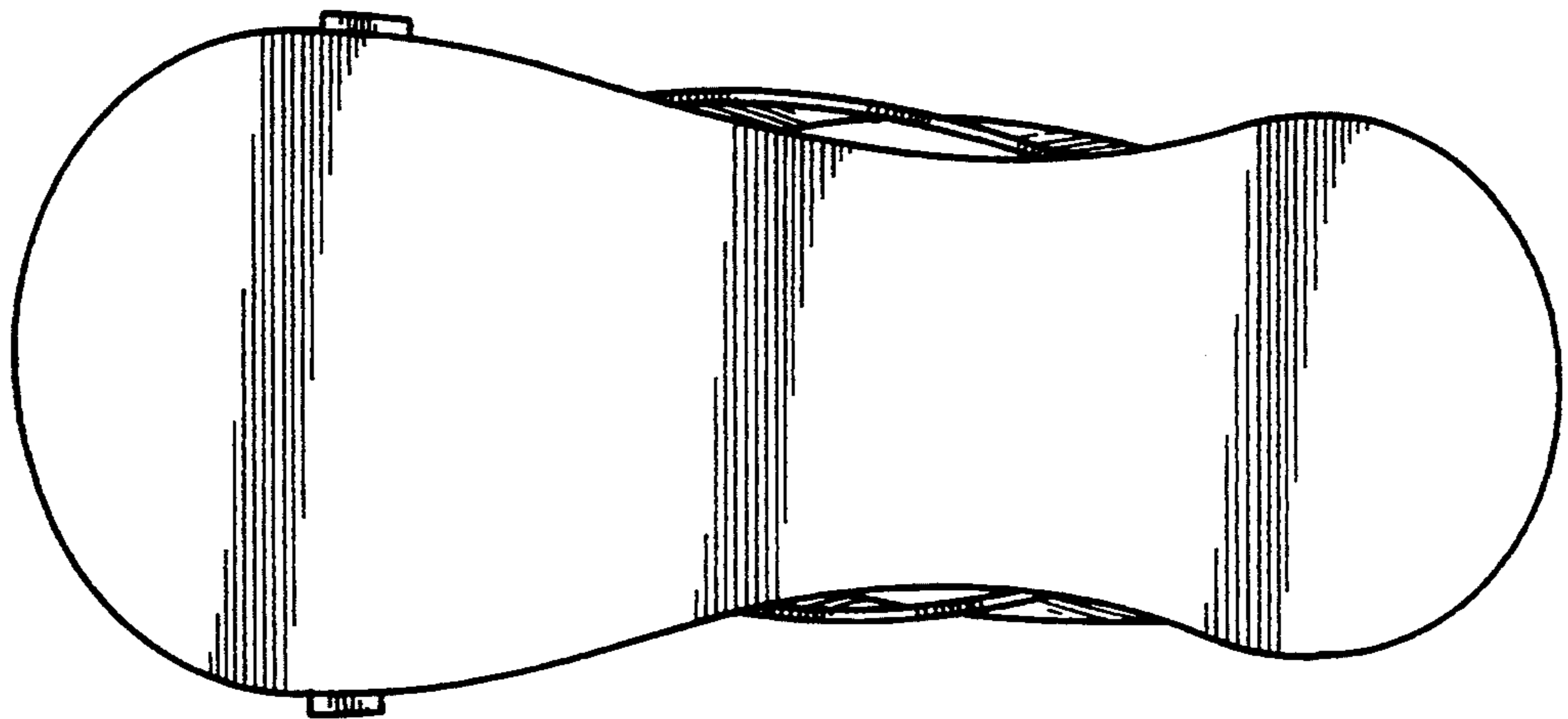

FIG.7.



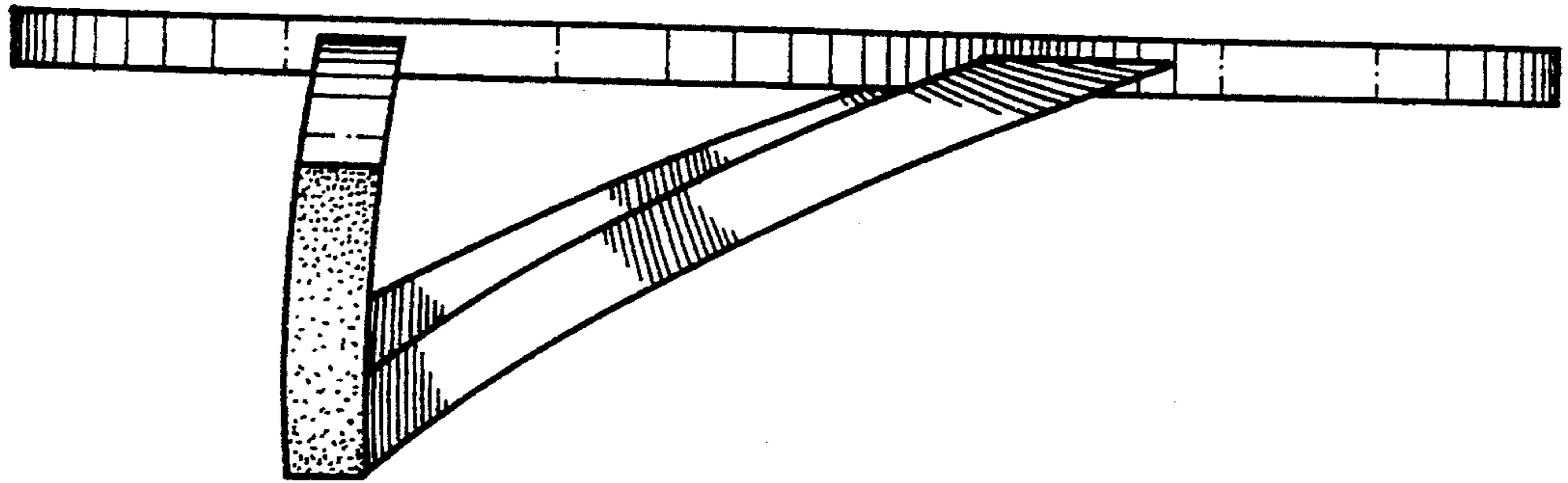

FIG. 5.

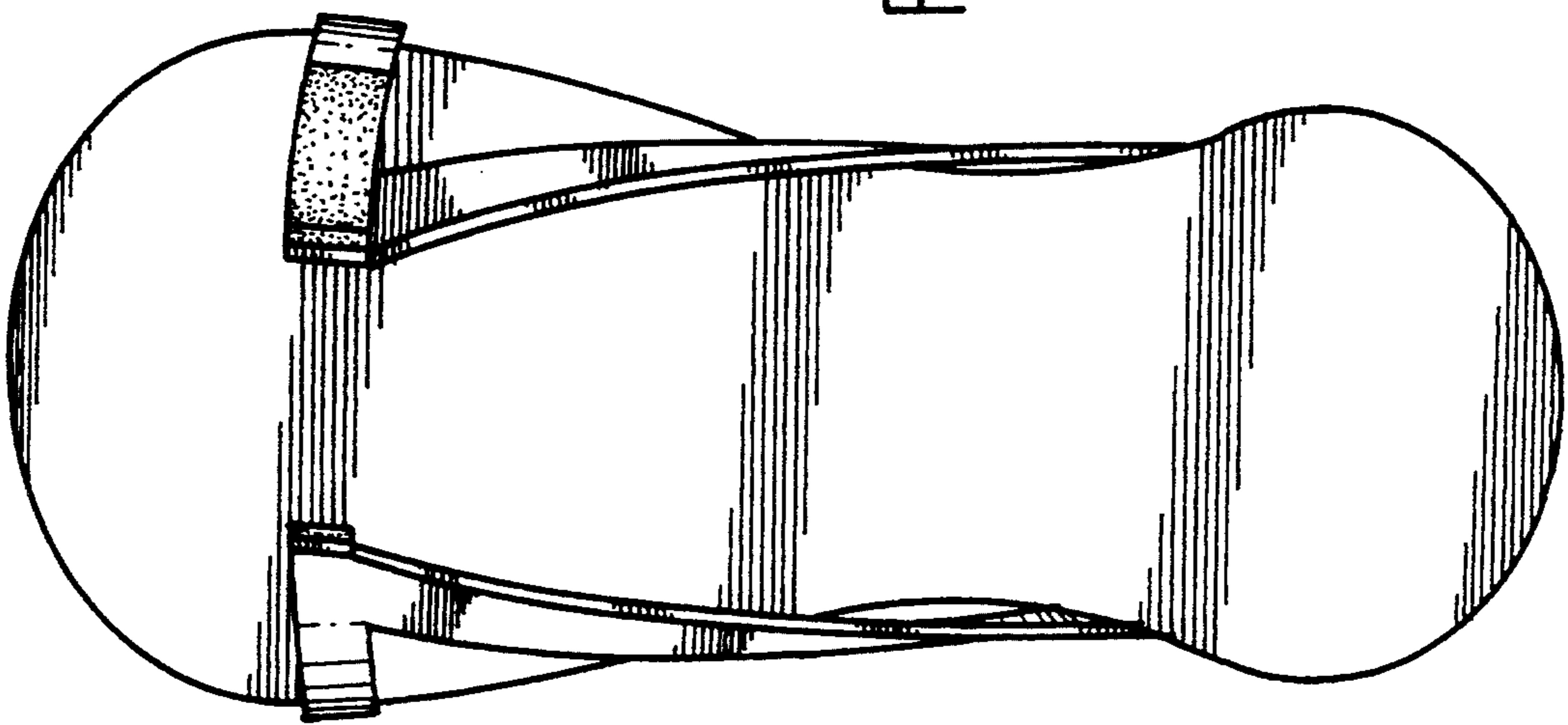

FIG. 6.