



US00D356332S

# United States Patent [19]

[11] Patent Number: **Des. 356,332**

**Kubota et al.**

[45] Date of Patent: **\*\* Mar. 14, 1995**

[54] **INK CARTRIDGE FOR PRINTER**

[75] Inventors: **Hidemi Kubota**, Komae; **Toshihiko Ujita**, Yamato; **Kenjiro Watanabe**, Tokyo; **Torachika Osada**, Yokohama; **Kayomi Sato**, Kawasaki, all of Japan

[73] Assignee: **Canon Kabushiki Kaisha**, Tokyo, Japan

[\*] Notice: The portion of the term of this patent subsequent to Jul. 5, 2008 has been disclaimed.

[\*\*] Term: **14 Years**

[21] Appl. No.: **10,094**

[22] Filed: **Jun. 28, 1993**

[30] **Foreign Application Priority Data**

Dec. 29, 1992 [JP] Japan ..... 4-38985

[52] U.S. Cl. .... **D18/56**

[58] Field of Search ..... 346/140 R; 400/280, 400/234; D18/12, 56

[56] **References Cited**

**U.S. PATENT DOCUMENTS**

- D. 331,939 12/1992 Ujita ..... D18/12
- D. 338,224 8/1993 Ujita ..... D18/12
- D. 338,232 8/1993 Kotaki et al. .... D18/56

- D. 338,234 8/1993 Watanabe et al. .... D18/56
- D. 338,489 8/1993 Ujita et al. .... D18/56
- D. 338,911 8/1993 Ujita et al. .... D18/56
- D. 341,619 11/1993 Ujita et al. .... D18/56
- D. 341,620 11/1993 Ujita et al. .... D18/56
- 4,992,802 2/1991 Dion et al. .... 346/140 R
- 5,162,817 11/1991 Tajika et al. .... 346/140 R
- 5,187,498 2/1993 Burger ..... 346/140 R

**FOREIGN PATENT DOCUMENTS**

- 3958 1/1988 Japan ..... 346/140 R
- 4954 1/1988 Japan ..... 346/140 R
- 37954 2/1988 Japan ..... 346/140 R

*Primary Examiner*—Cathy Anne MacCormac  
*Attorney, Agent, or Firm*—Fitzpatrick, Cella, Harper & Scinto

[57] **CLAIM**

The ornamental design for an ink cartridge for printer, as shown and described.

**DESCRIPTION**

FIG. 1 is a front elevational view of an ink cartridge for printer showing our new design; FIG. 2 is a rear elevational view thereof; FIG. 3 is a top plan view thereof; FIG. 4 is a bottom plan view thereof; FIG. 5 is a left side elevational view thereof; FIG. 6 is a right side elevational view thereof; and, FIG. 7 is a perspective view thereof.

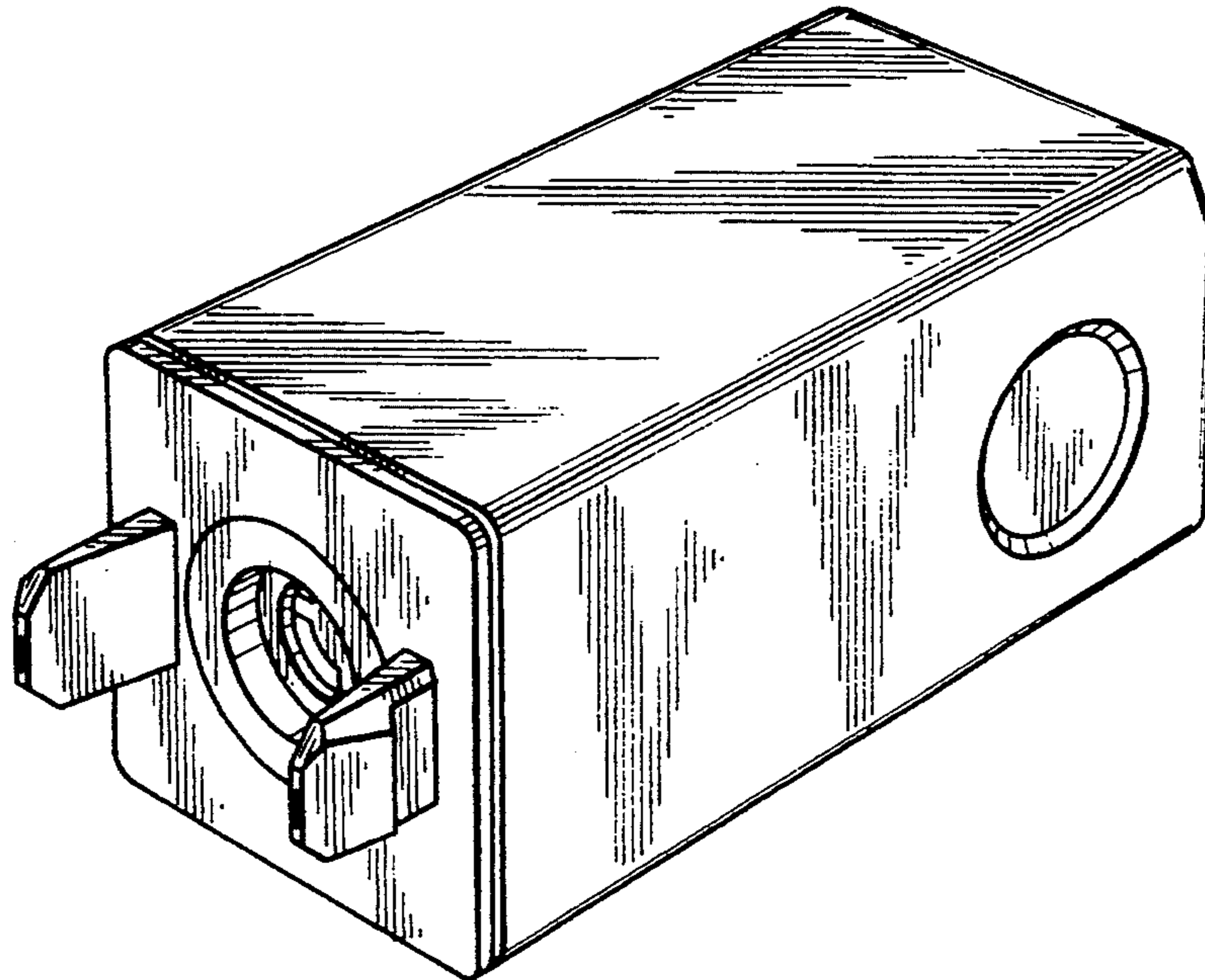

FIG. 1

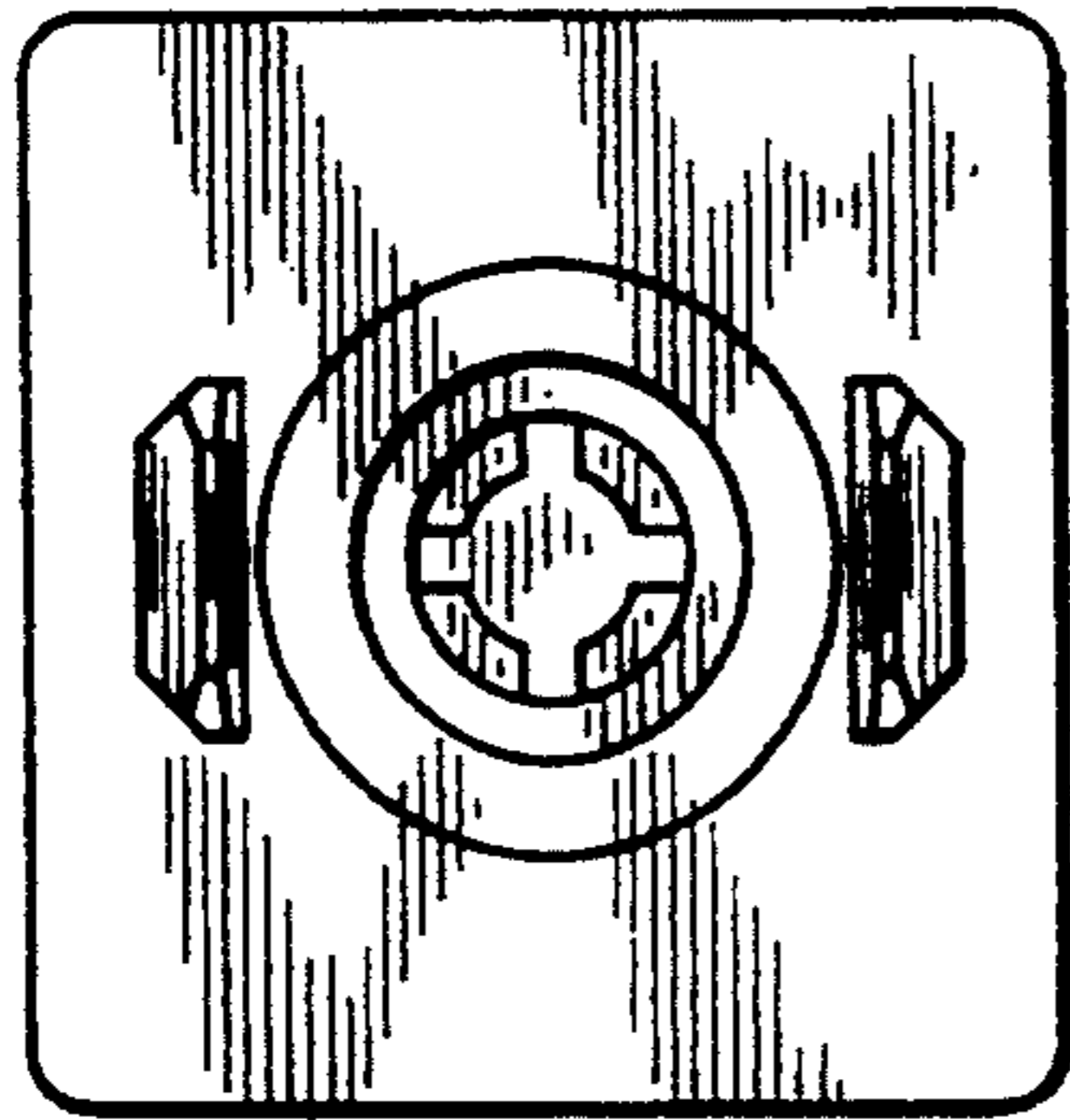

FIG. 2

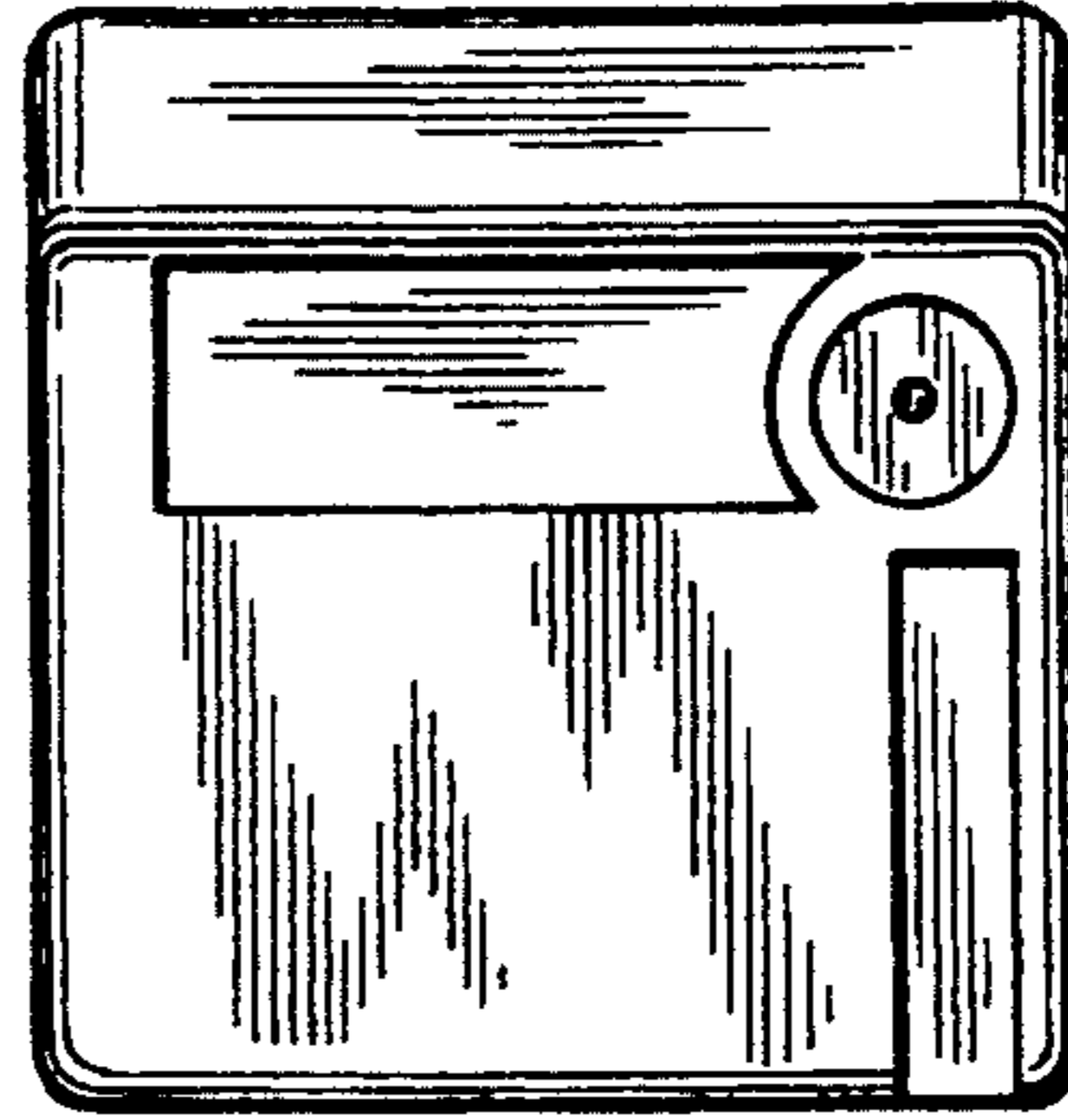

FIG. 3

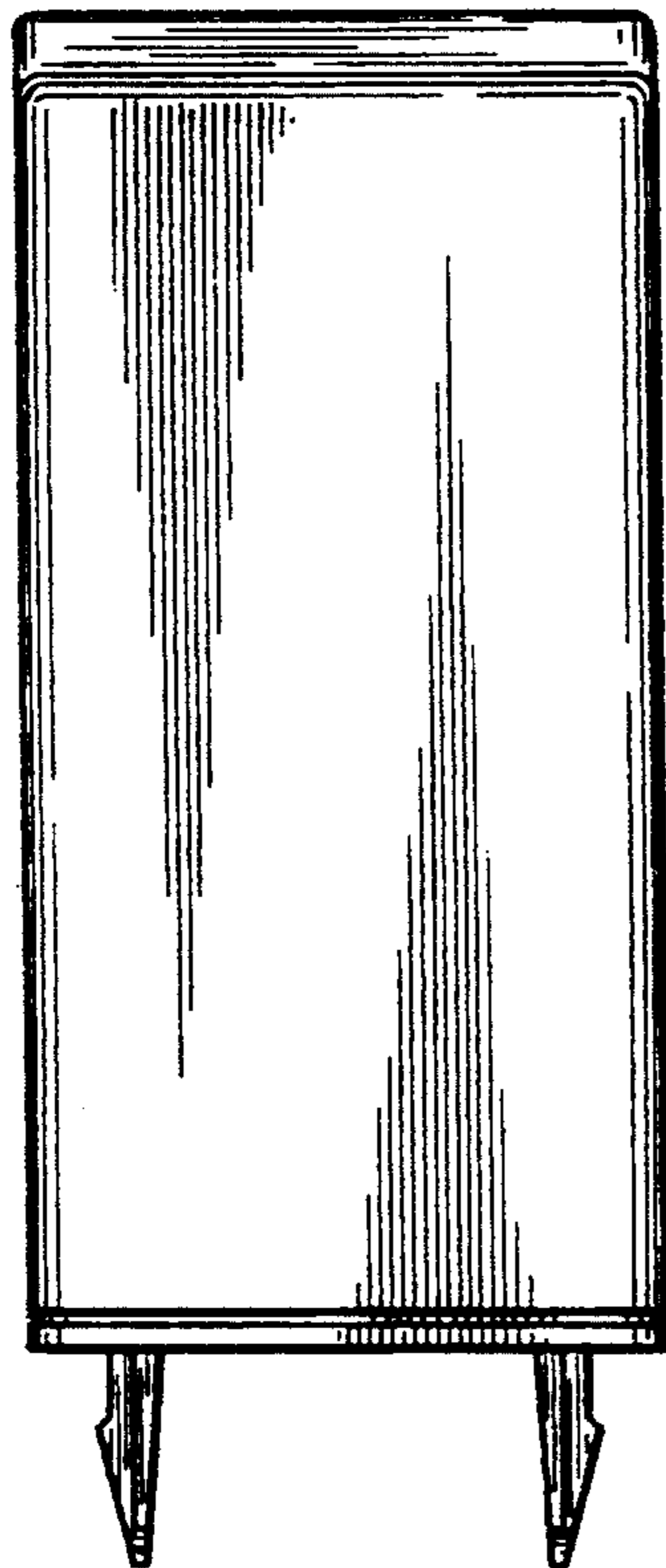

FIG. 4

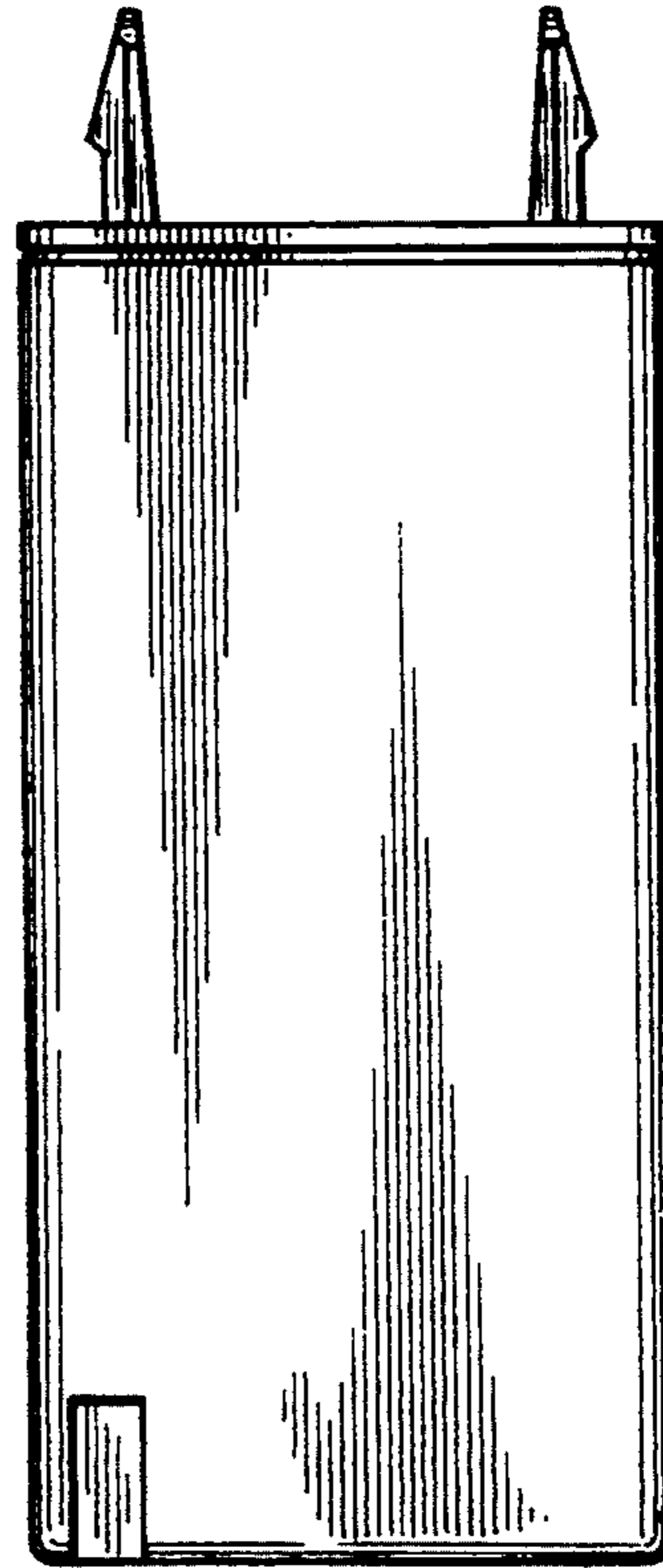

FIG. 5

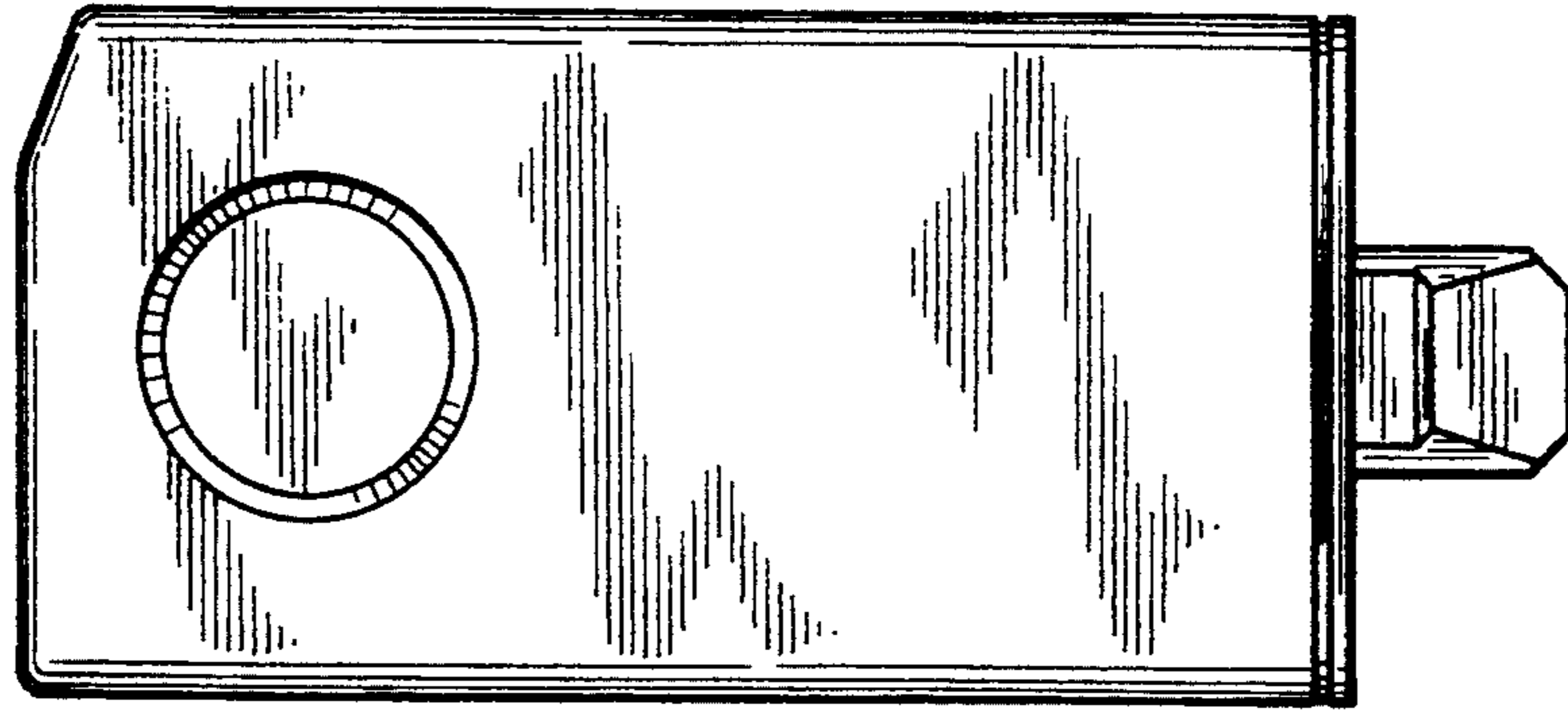

FIG. 6

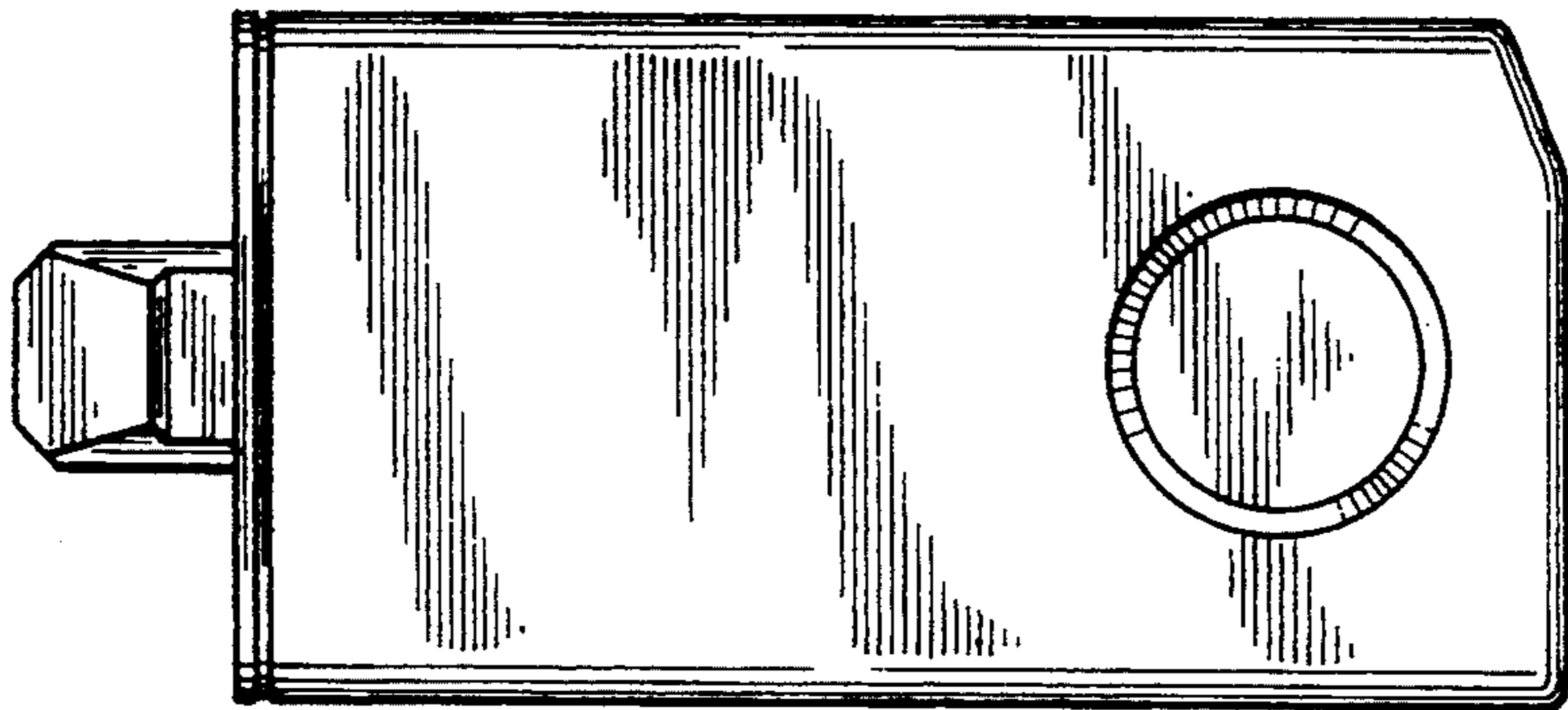

FIG. 7

