



US00D356325S

United States Patent [19]

[11] Patent Number: **Des. 356,325**

Sogabe

[45] Date of Patent: **** Mar. 14, 1995**

[54] VIDEO CAMERA COMBINED WITH A TAPE RECORDER

[75] Inventor: **Takashi Sogabe**, Tokyo, Japan

[73] Assignee: **Sony Corporation**, Tokyo, Japan

[**] Term: **14 Years**

[21] Appl. No.: **2,647**

[22] Filed: **Dec. 15, 1992**

[30] Foreign Application Priority Data

Jun. 25, 1992 [JP] Japan 4-18991

[52] U.S. Cl. **D16/202**

[58] Field of Search D16/200, 202, 203-205, D16/208; 352/34, 242, 243; 354/82, 288; 358/229, 906

[56] References Cited

U.S. PATENT DOCUMENTS

- D. 294,570 3/1988 Kurokawa et al. D16/202
- D. 334,394 3/1993 Kitakaze D16/202
- D. 334,761 4/1993 Ina et al. D16/202
- D. 337,778 7/1993 Matsumura D16/202
- D. 341,151 11/1993 Ina et al. D16/202

OTHER PUBLICATIONS

J & R Music World, Winter 1989 p. 35 (Sony's CCD SP7 Handycam).

Ritz Camera Catalog, p. 7 (Sony's CCD-TR7).

Primary Examiner—Melvin B. Feifer

Assistant Examiner—Adir Aronovich

Attorney, Agent, or Firm—Jay H. Maioli

[57] CLAIM

The ornamental design for a video camera combined with a tape recorder, as shown and described.

DESCRIPTION

FIG. 1 is a top, front and left-side perspective view of a video camera combined with a tape recorder, showing my new design;

FIG. 2 is a top, front and right-side perspective view thereof, shown with viewfinder in the raised position;

FIG. 3 is a front elevational view thereof;

FIG. 4 is a rear elevational view thereof;

FIG. 5 is a left-side elevational view thereof;

FIG. 6 is a right-side elevational view thereof;

FIG. 7 is a top plan view thereof; and,

FIG. 8 is a bottom plan view thereof.

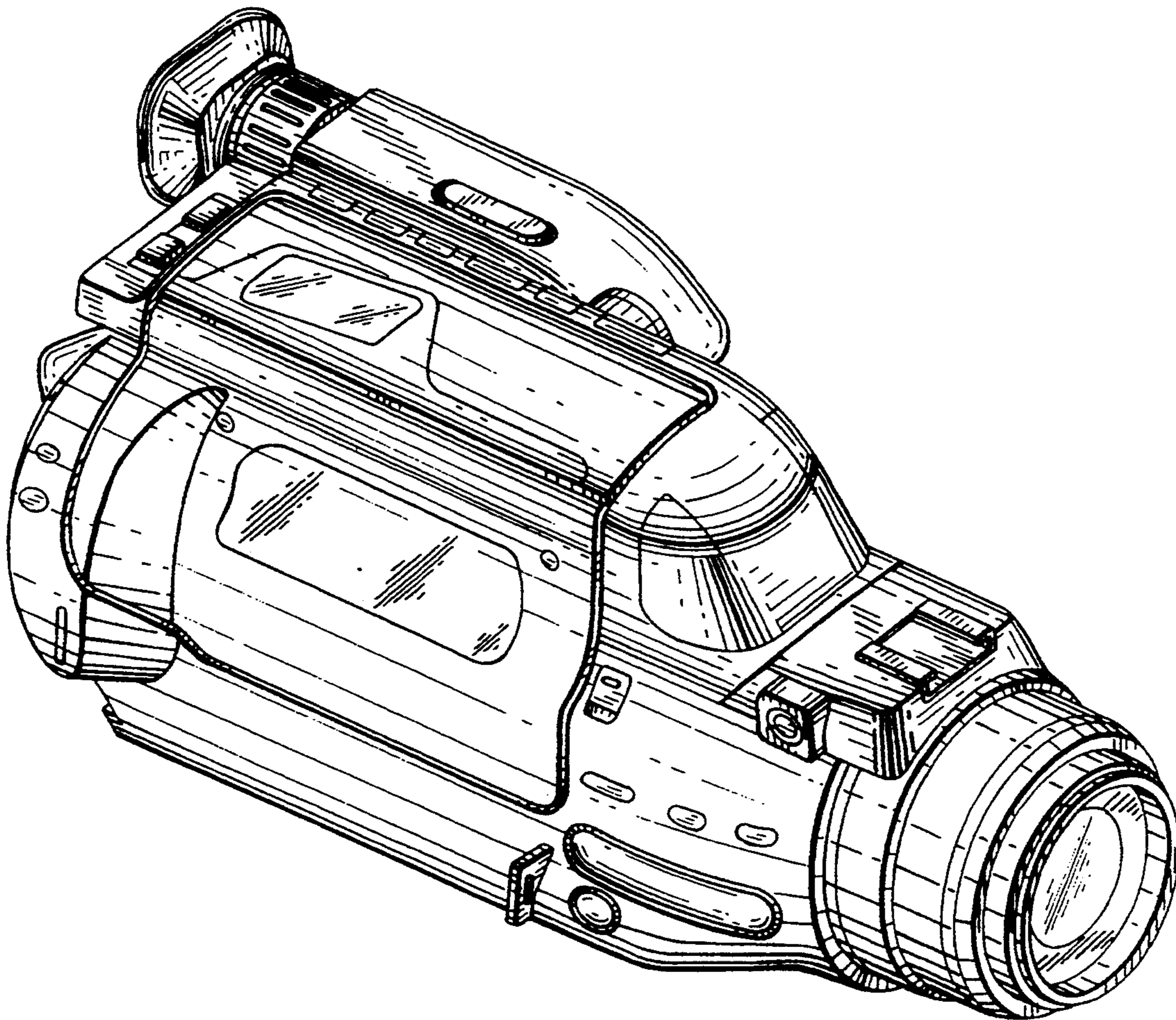
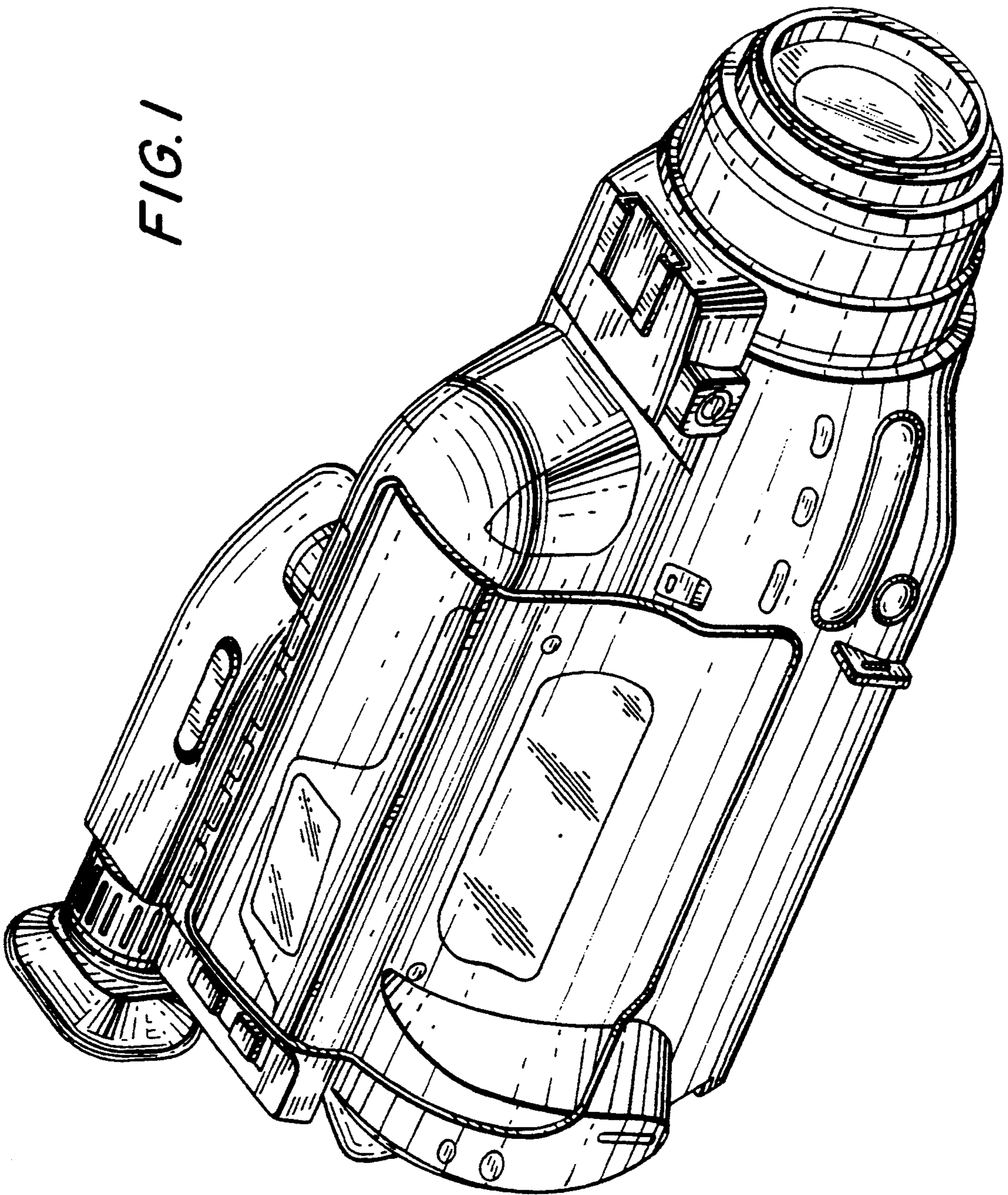

FIG. 1



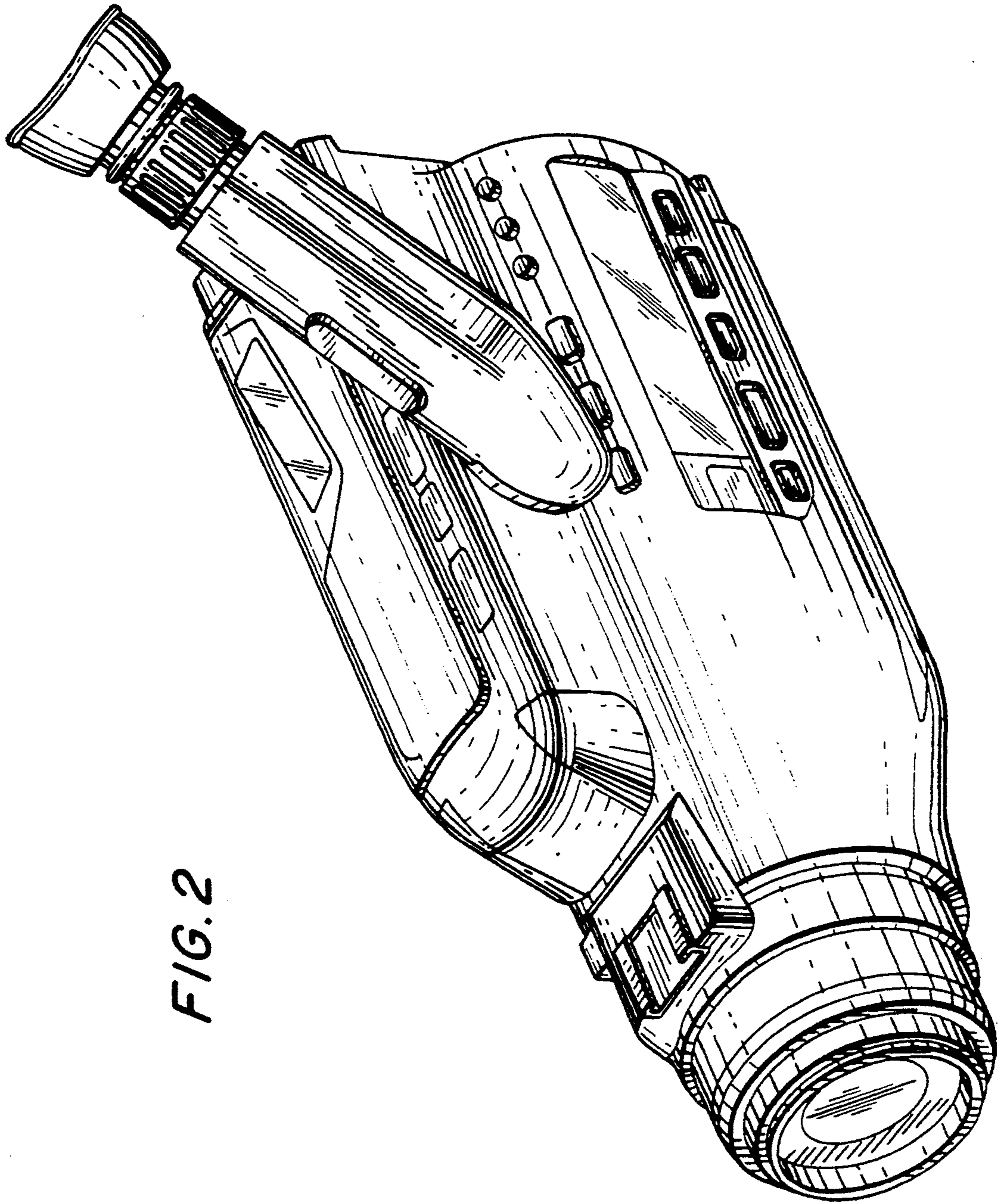

FIG. 2

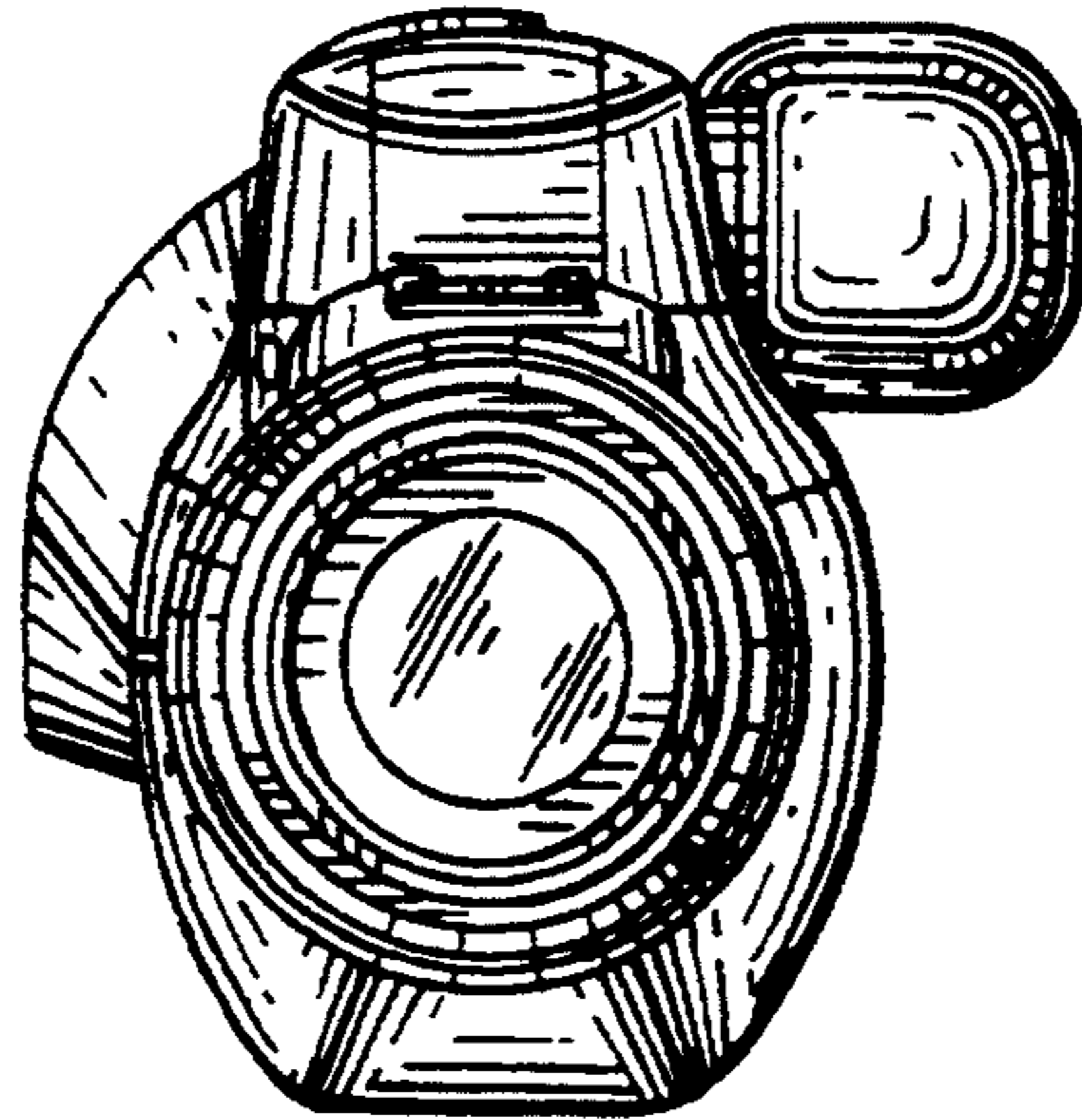

FIG. 3

FIG. 5

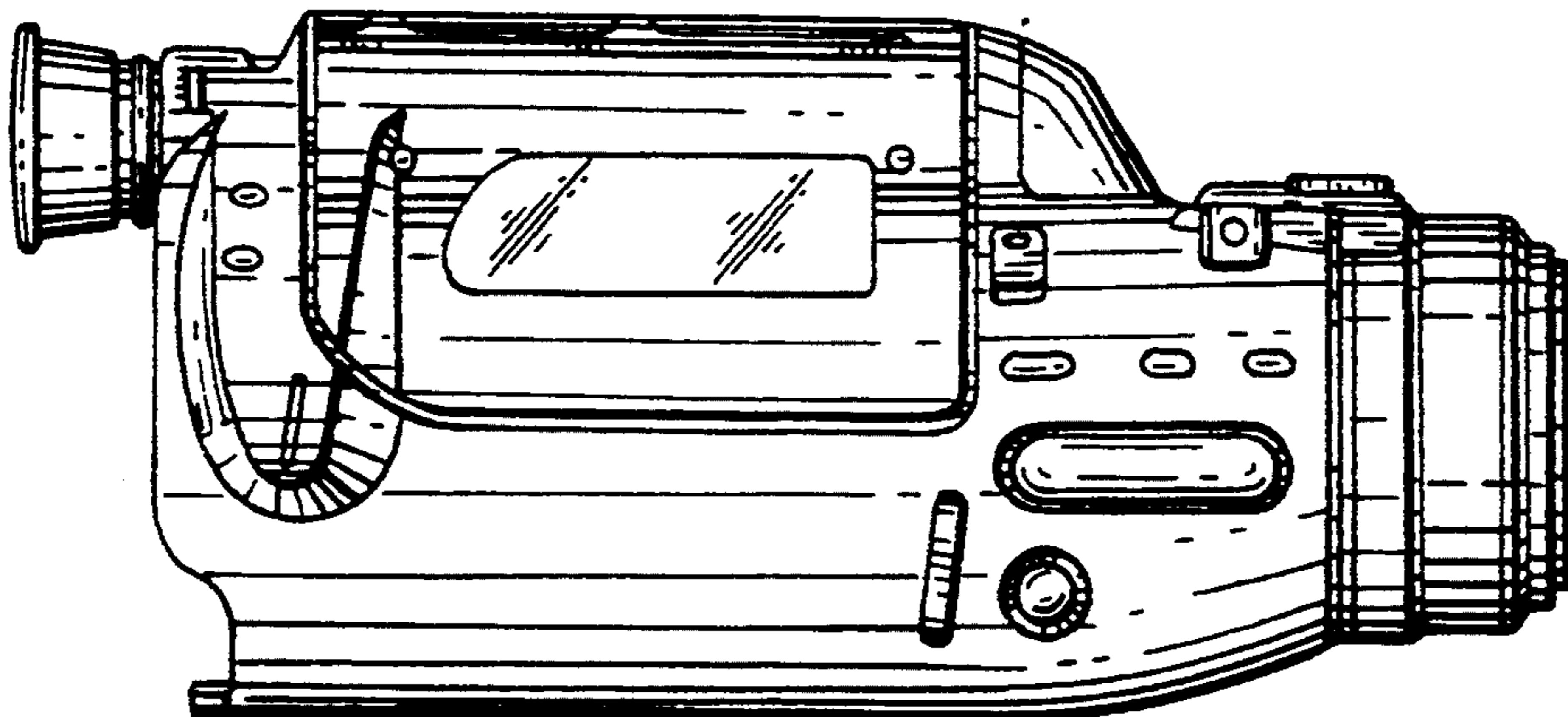

FIG. 4

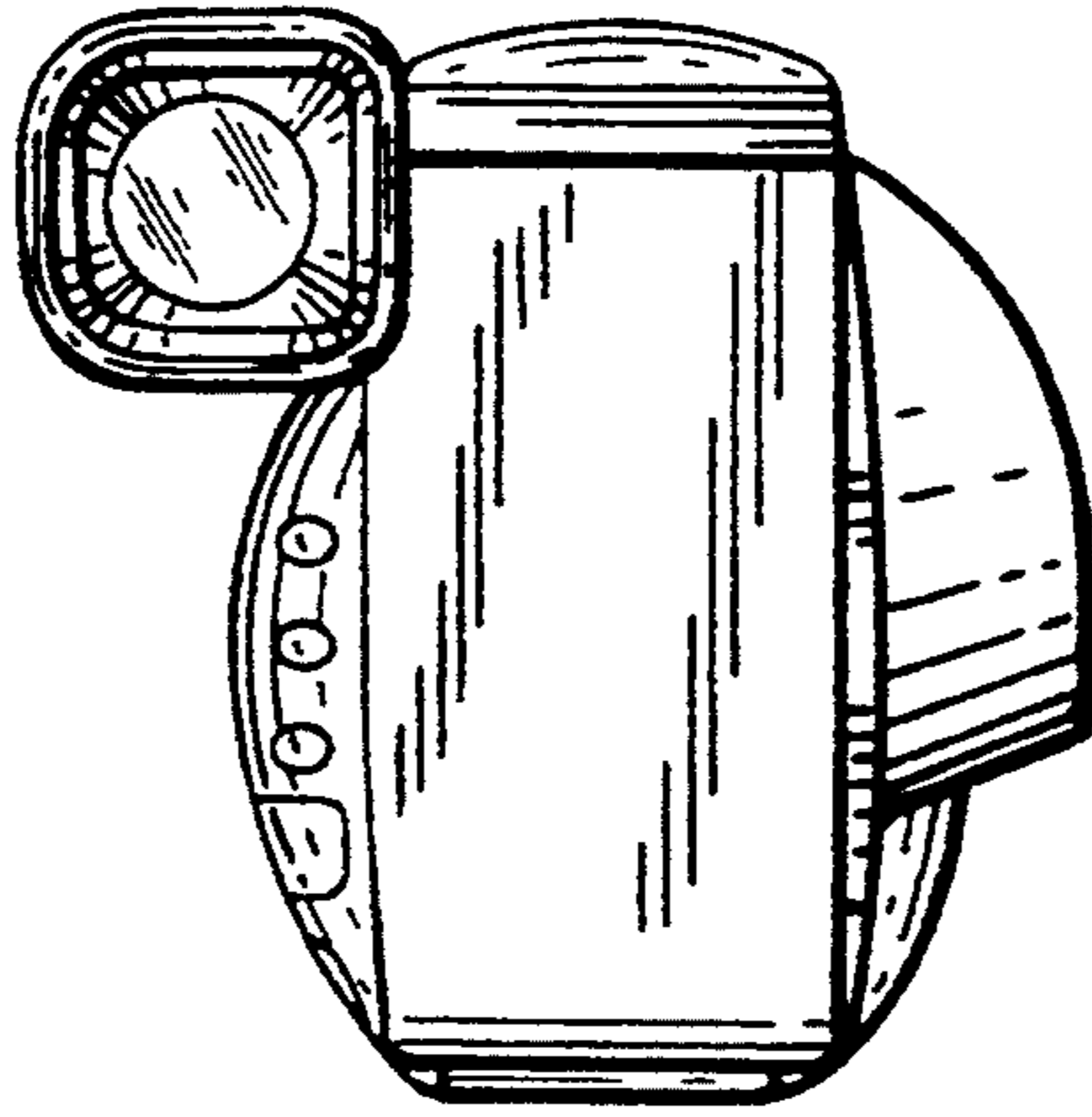

FIG. 7

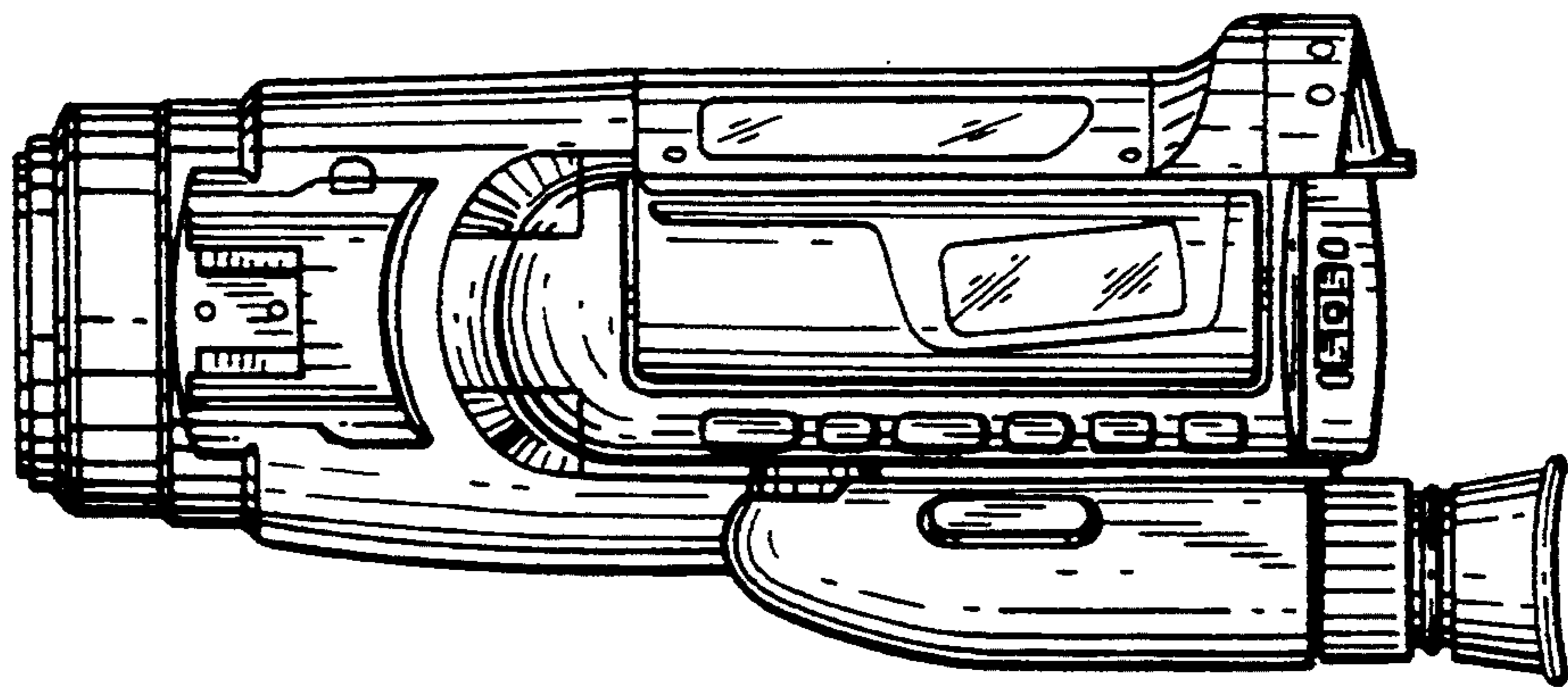

FIG. 6

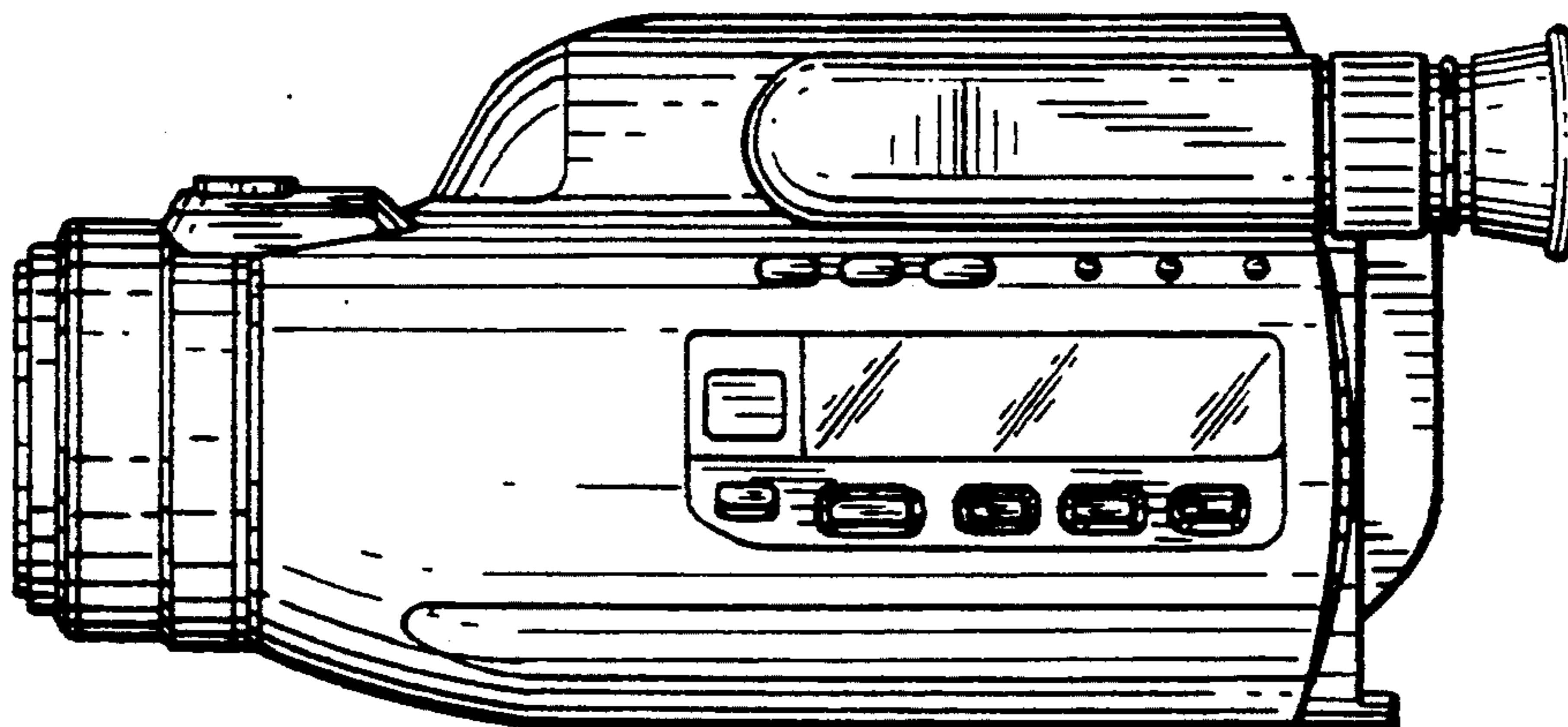

FIG. 8

