



US00D356260S

**United States Patent** [19]  
**Frank**

[11] **Patent Number: Des. 356,260**  
[45] **Date of Patent: \*\* Mar. 14, 1995**

- [54] **REPLACEMENT CAP FOR A WATER BOTTLE**
- [76] **Inventor: Stanley Frank, 1095 Mitch Rd., Lower Pottsgrove, Pa. 19464**
- [\*\*] **Term: 14 Years**
- [21] **Appl. No.: 1,203**
- [22] **Filed: Nov. 6, 1992**
- [52] **U.S. Cl. .... D9/446**
- [58] **Field of Search ..... D9/434-436, D9/444-449, 452-454, 440; D7/510-511, 608, 619; 215/306, 316-317; 220/375; 222/549, 566, 570; D8/303, 313, 315**

- [56] **References Cited**
- U.S. PATENT DOCUMENTS**
- |            |         |                |        |
|------------|---------|----------------|--------|
| D. 31,257  | 7/1899  | Mather .....   | D8/303 |
| D. 56,768  | 12/1920 | Rustant .....  | D9/439 |
| D. 324,824 | 3/1992  | Hansen .....   | D9/447 |
| 4,744,477  | 5/1988  | Wofford .      |        |
| 4,911,315  | 3/1990  | Shrum .        |        |
| 4,955,968  | 9/1990  | Beckerer ..... | D9/445 |
| 4,976,364  | 12/1990 | Solomon .      |        |

**OTHER PUBLICATIONS**

Stock ringed dome closures ad, D & CI Magazine, Feb. 1982, p. 58.

*Primary Examiner*—Alan P. Douglas  
*Assistant Examiner*—R. Spear  
*Attorney, Agent, or Firm*—Terry M. Gernstein

[57] **CLAIM**

The ornamental design for a replacement cap for a water bottle, as shown and described.

**DESCRIPTION**

FIG. 1 is a front, top and side perspective view of the replacement cap for a water bottle embodying the design of the present invention;

FIG. 2 is a front elevational view thereof, and being shown in an alternative position of use;

FIG. 3 is a side elevational view thereof, the side opposite being a mirror image of the side shown in FIG. 3;

FIG. 4 is a top plan view thereof;

FIG. 5 is a bottom plan view thereof;

FIG. 6 is a rear elevational view thereof; and,

FIG. 7 is a cross sectional view thereof.

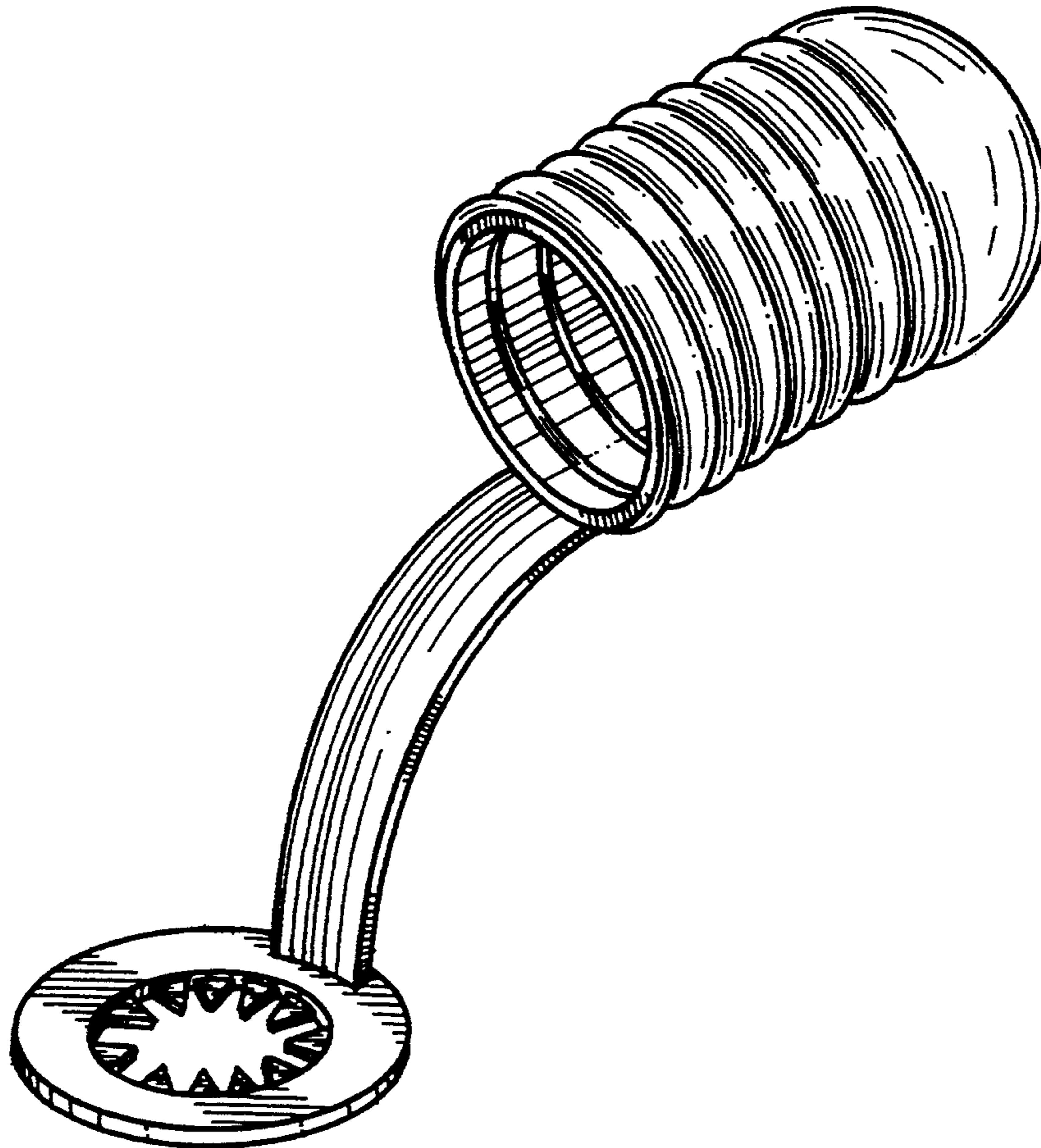

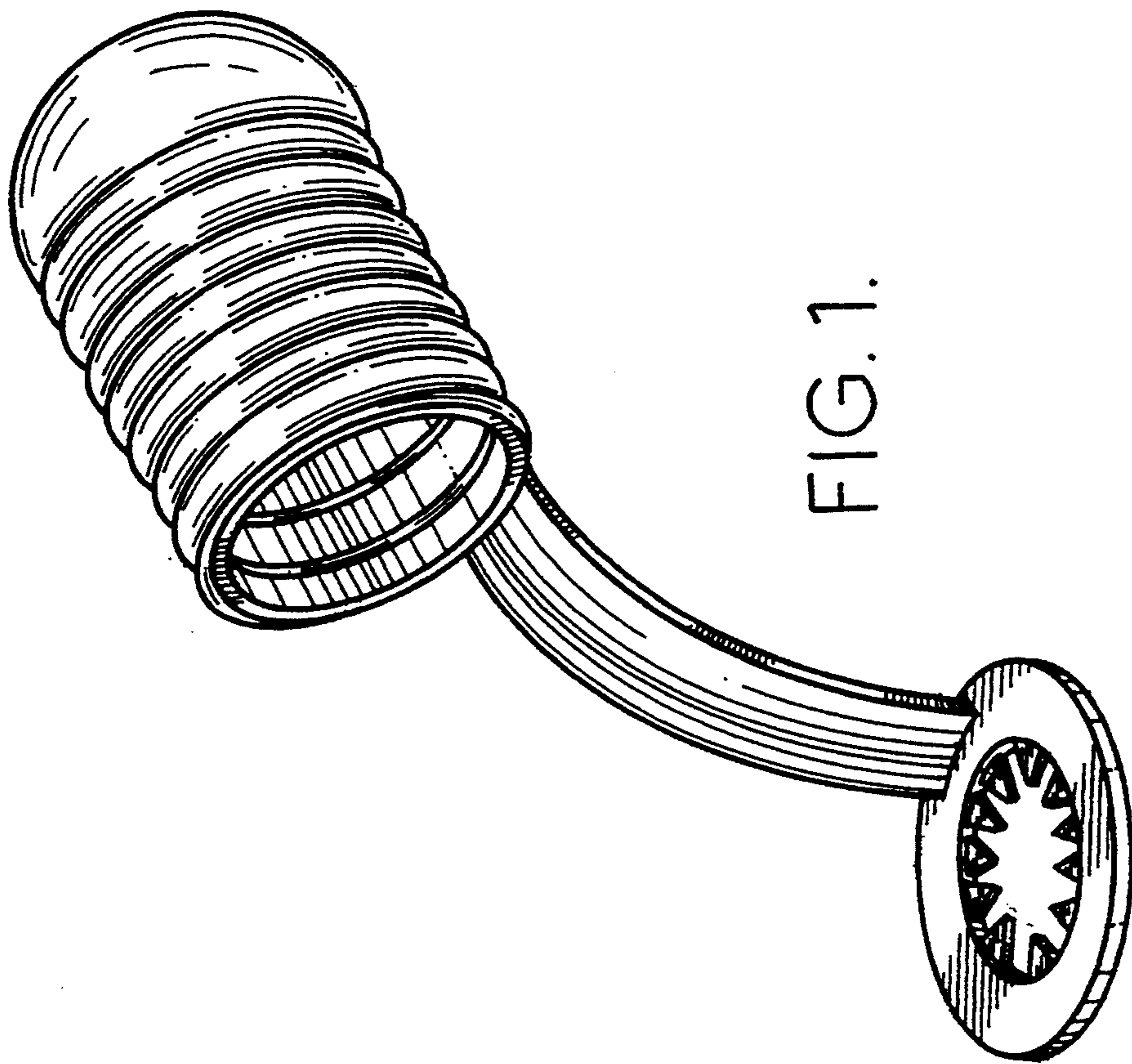

FIG. 1.

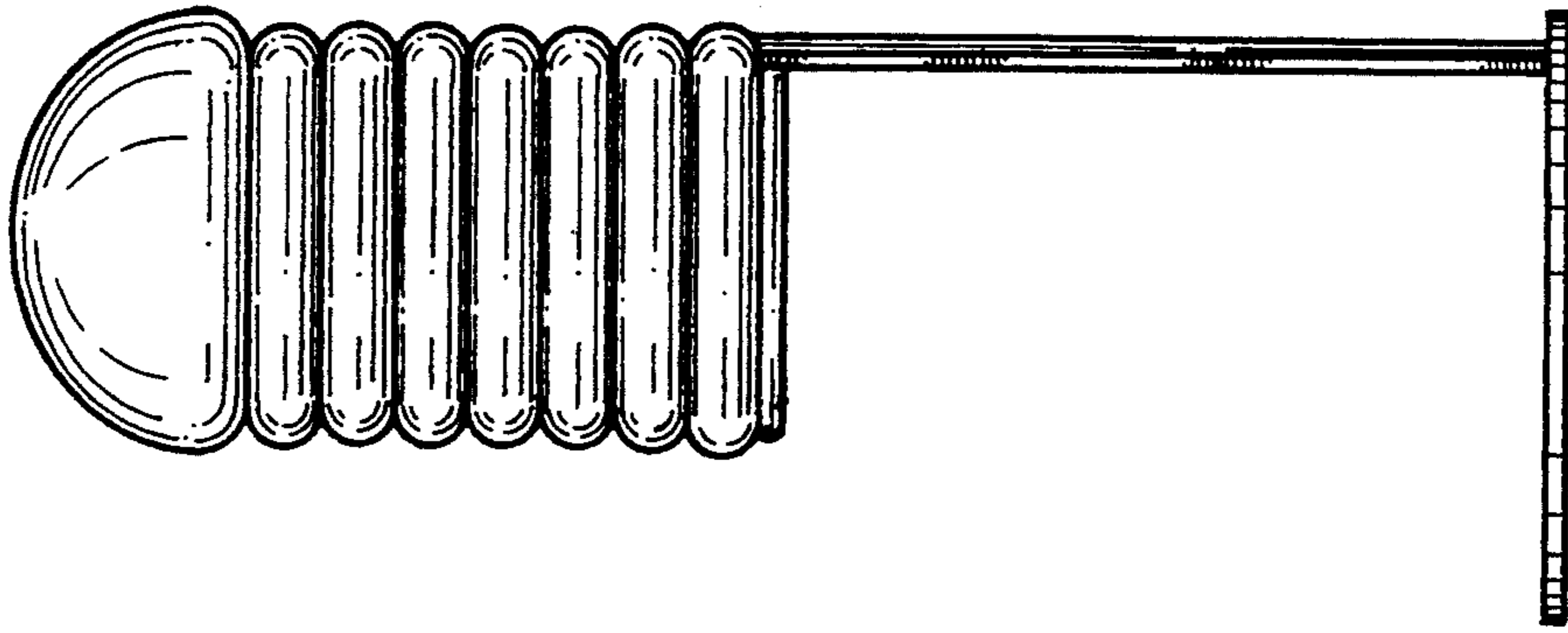

FIG. 3.

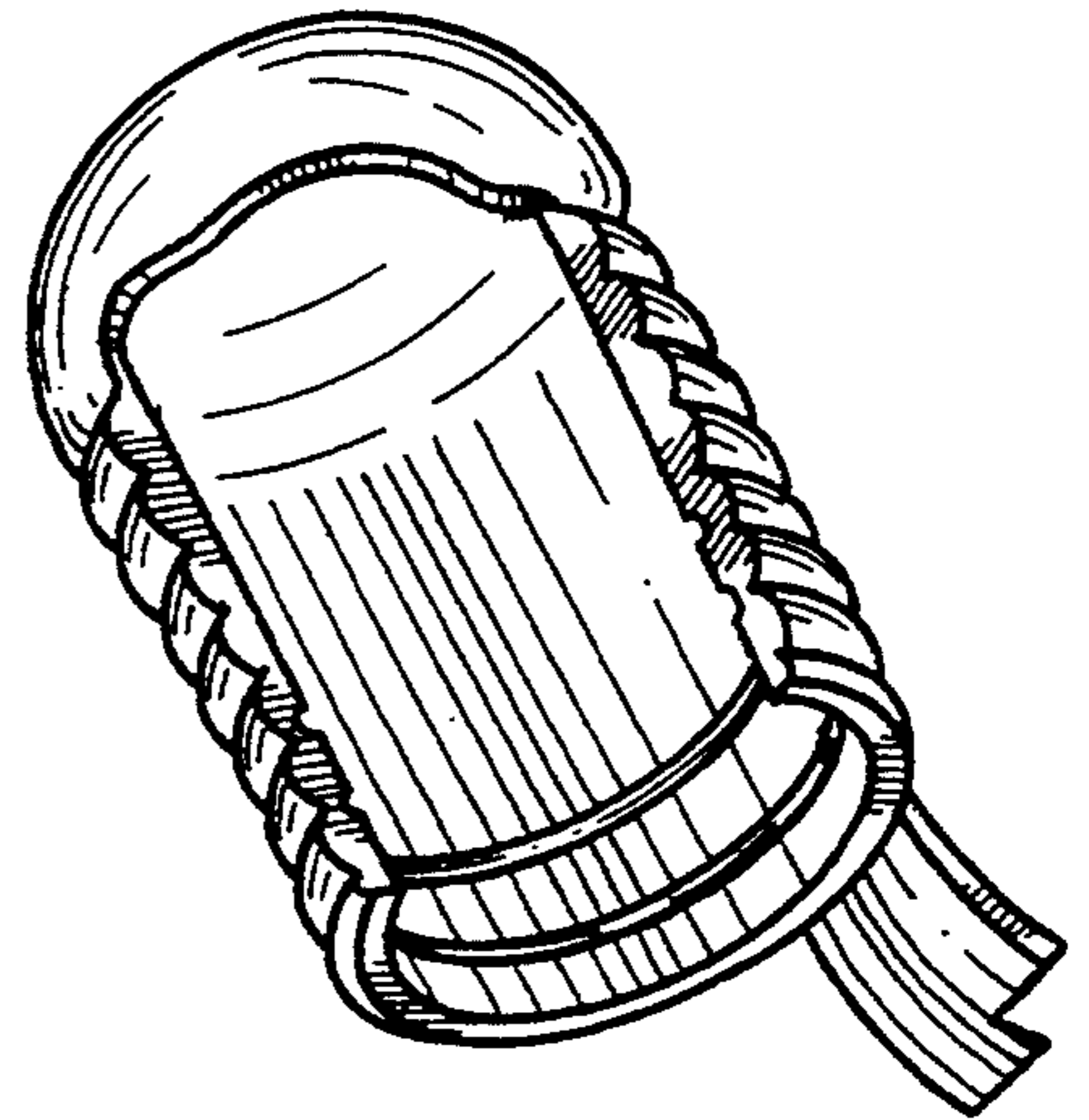

FIG. 7.

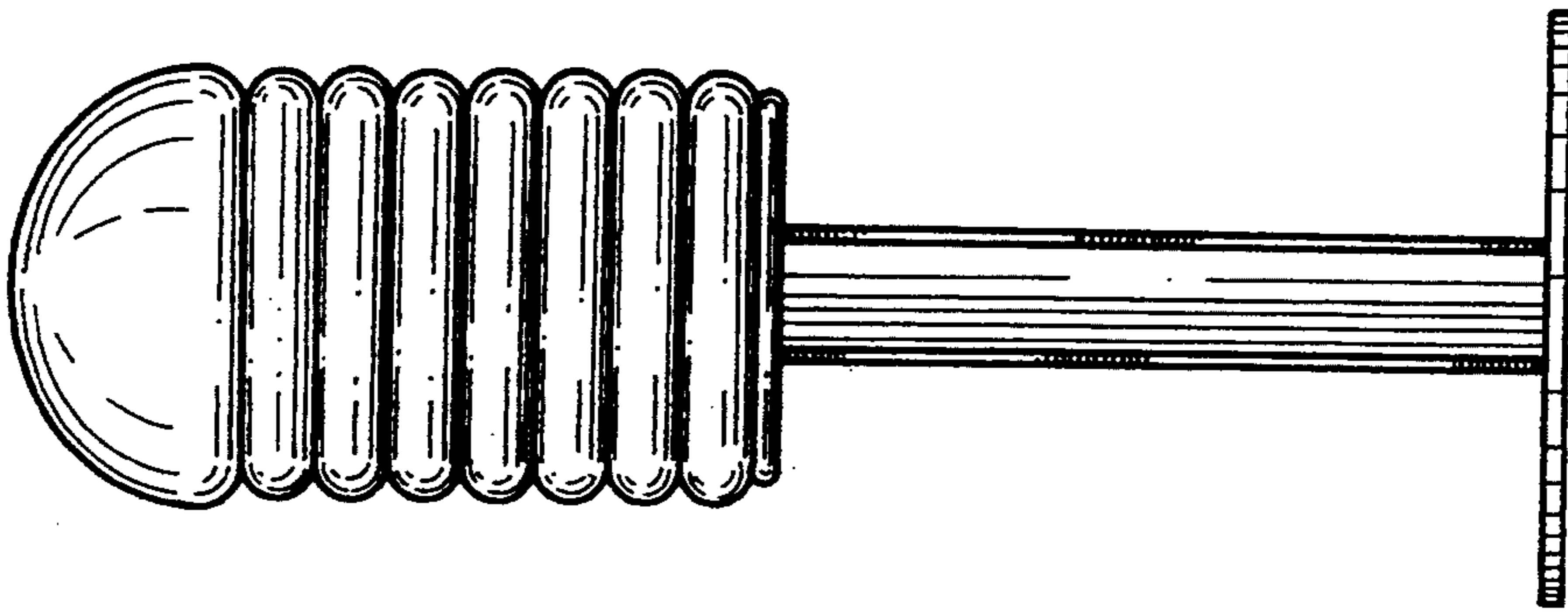

FIG. 2.

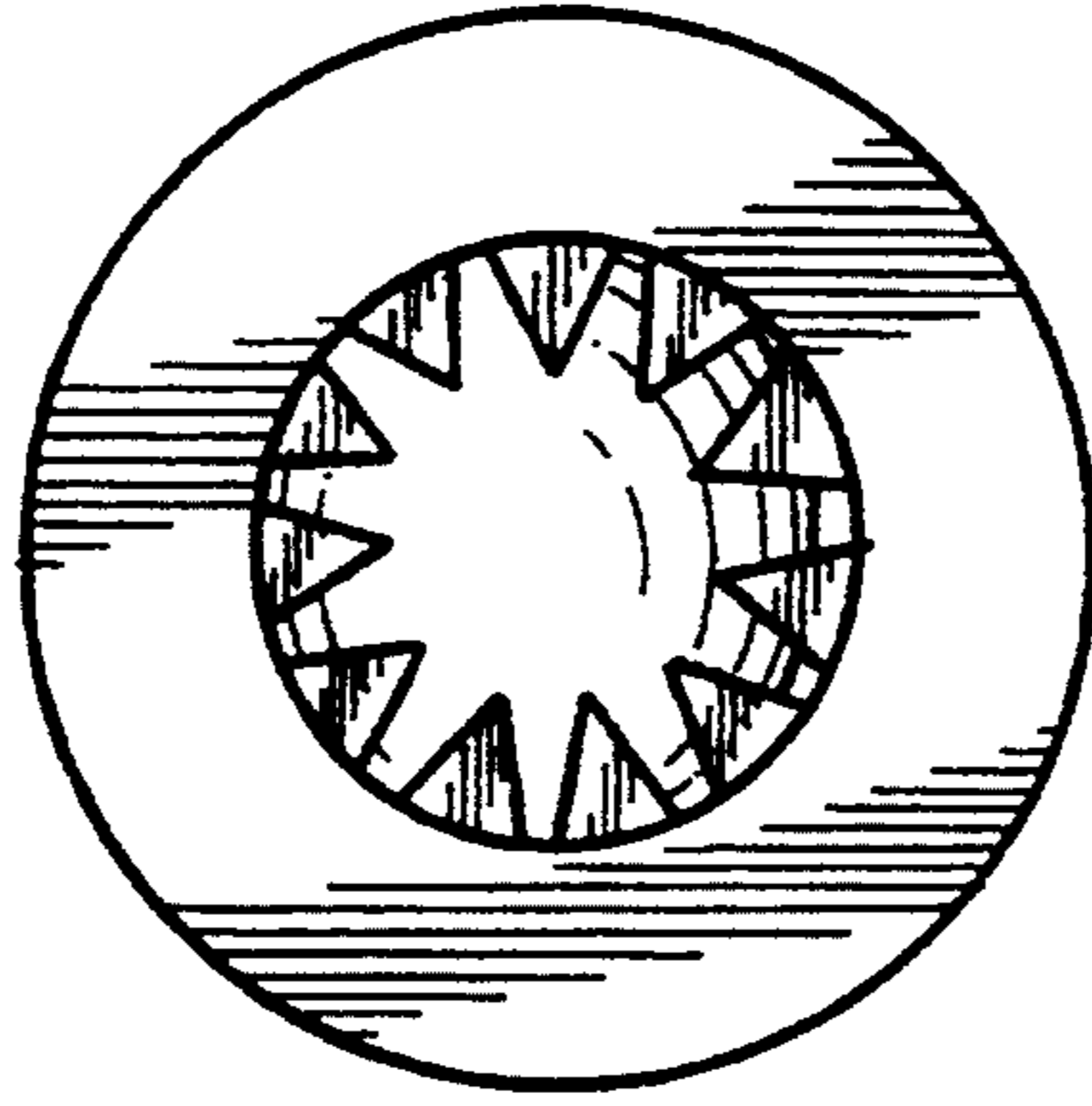

FIG. 5.

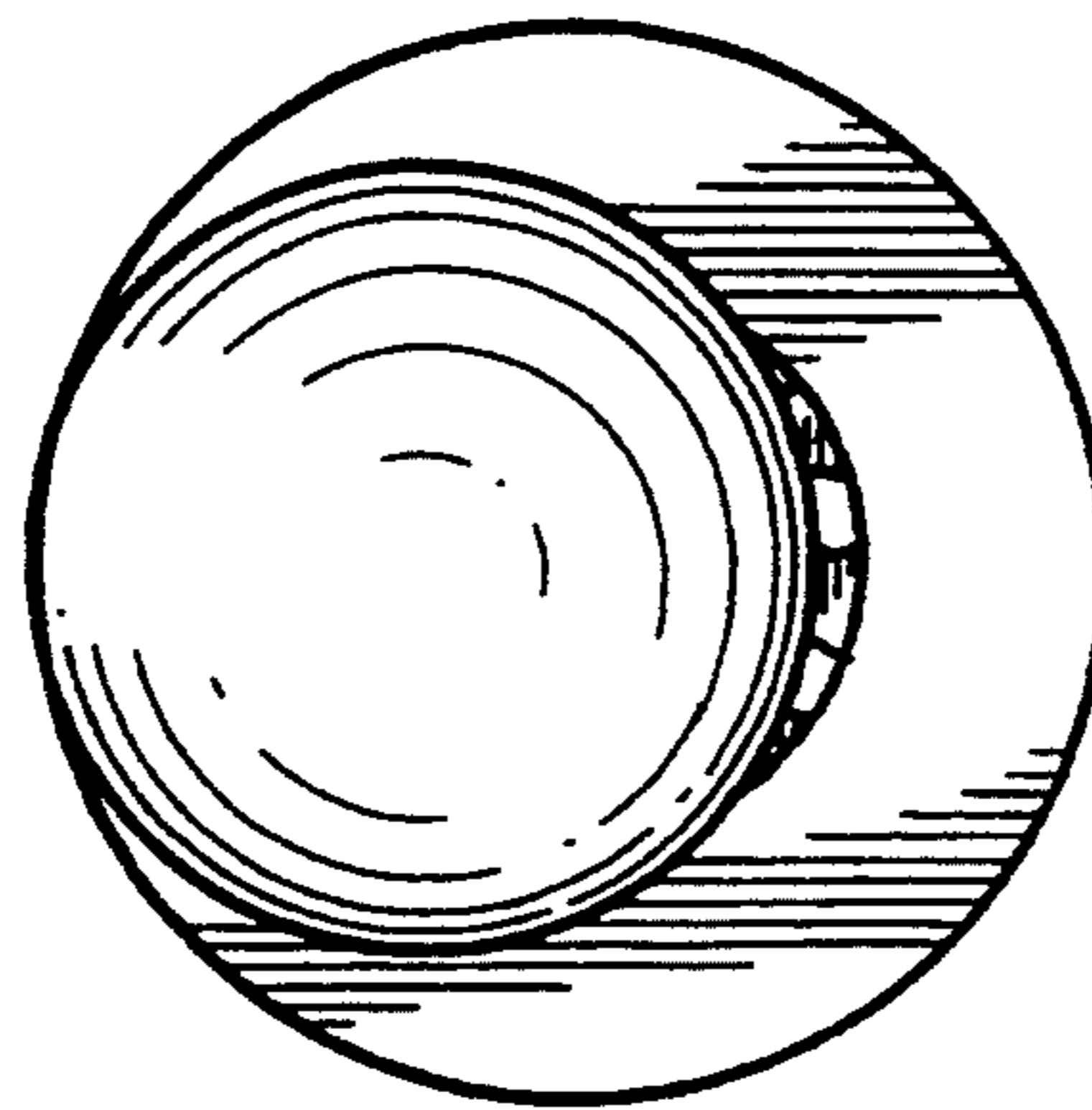

FIG. 4.

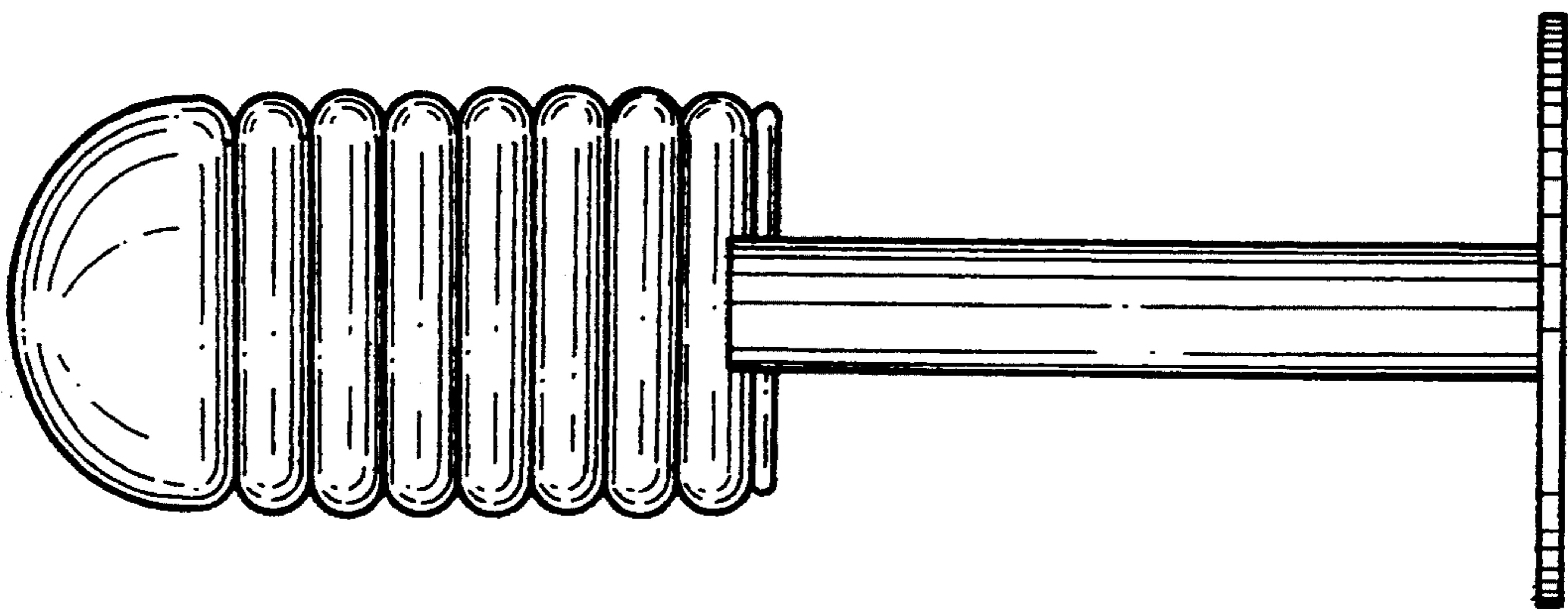

FIG. 6.