



US00D356229S

United States Patent [19]

[11] Patent Number: Des. 356,229

Stein

[45] Date of Patent: ** Mar. 14, 1995

[54] PEDESTAL MOUNTED DRINKING FOUNTAIN

[75] Inventor: Matthew I. Stein, Truckee, Calif.

[73] Assignee: Haws Company, Sparks, Nebr.

[**] Term: 14 Years

[21] Appl. No.: 9,656

[22] Filed: Jun. 21, 1993

[52] U.S. Cl. D7/304; D7/300

[58] Field of Search D7/300, 304, 213, 305, D7/306; D23/201; 239/24, 28, 29, 29.5

[56] References Cited

U.S. PATENT DOCUMENTS

D. 217,401	4/1970	Lazzo, III	D7/304
D. 223,782	6/1972	Wright	D7/304
D. 343,330	1/1994	Windenburg et al.	D7/304
3,734,408	5/1973	Wright	239/29

OTHER PUBLICATIONS

Oasis Water Cooler, Oasis Catalog p. 7.

Primary Examiner—Alan P. Douglas

Assistant Examiner—M. N. Pandozzi

Attorney, Agent, or Firm—Kelly Bauersfeld & Lowry

[57] CLAIM

The ornamental design for a pedestal mounted drinking fountain, as shown and described.

DESCRIPTION

FIG. 1 is a perspective view showing the top, front and right sides of a pedestal mounted drinking fountain embodying my new design;

FIG. 2 is a right side elevational view thereof;

FIG. 3 is a rear elevational view thereof;

FIG. 4 is a front elevational view thereof;

FIG. 5 is a left side elevational view thereof;

FIG. 6 is a top plan view thereof;

FIG. 7 is a bottom plan view thereof;

FIG. 8 is a perspective view of a pedestal mounted drinking fountain, showing a second embodiment of my new design;

FIG. 9 is a perspective view illustrating the top, rear and left sides of the embodiment of FIG. 8;

FIG. 10 is a right side elevational view of the embodiment of FIG. 8;

FIG. 11 is a rear elevational view of the embodiment of FIG. 8;

FIG. 12 is a front elevational view of the embodiment of FIG. 8;

FIG. 13 is a left side elevational view of the embodiment of FIG. 8;

FIG. 14 is a top plan view of the embodiment of FIG. 8; and,

FIG. 15 is a bottom plan view of the embodiment of FIG. 8.

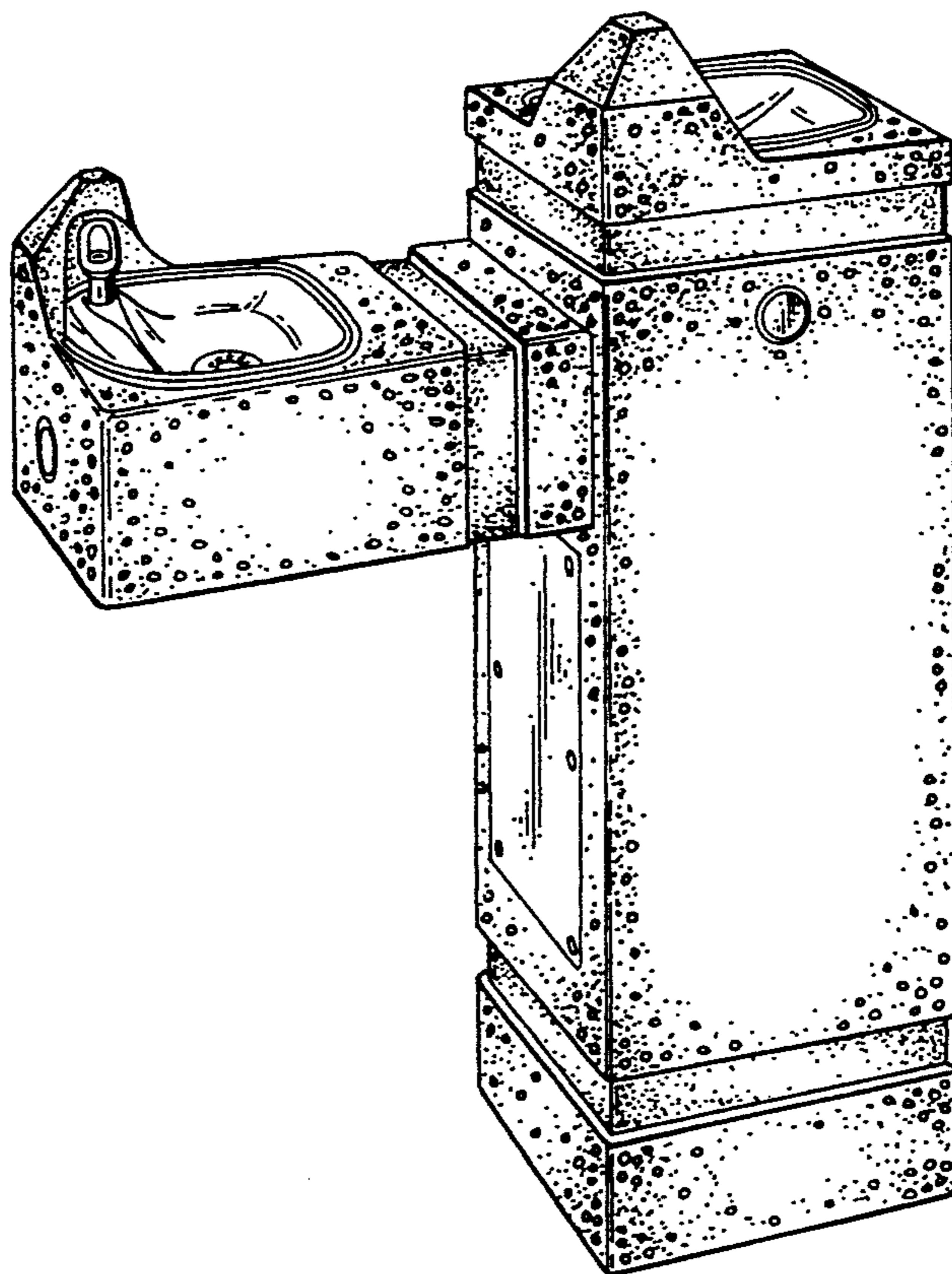

FIG. 1

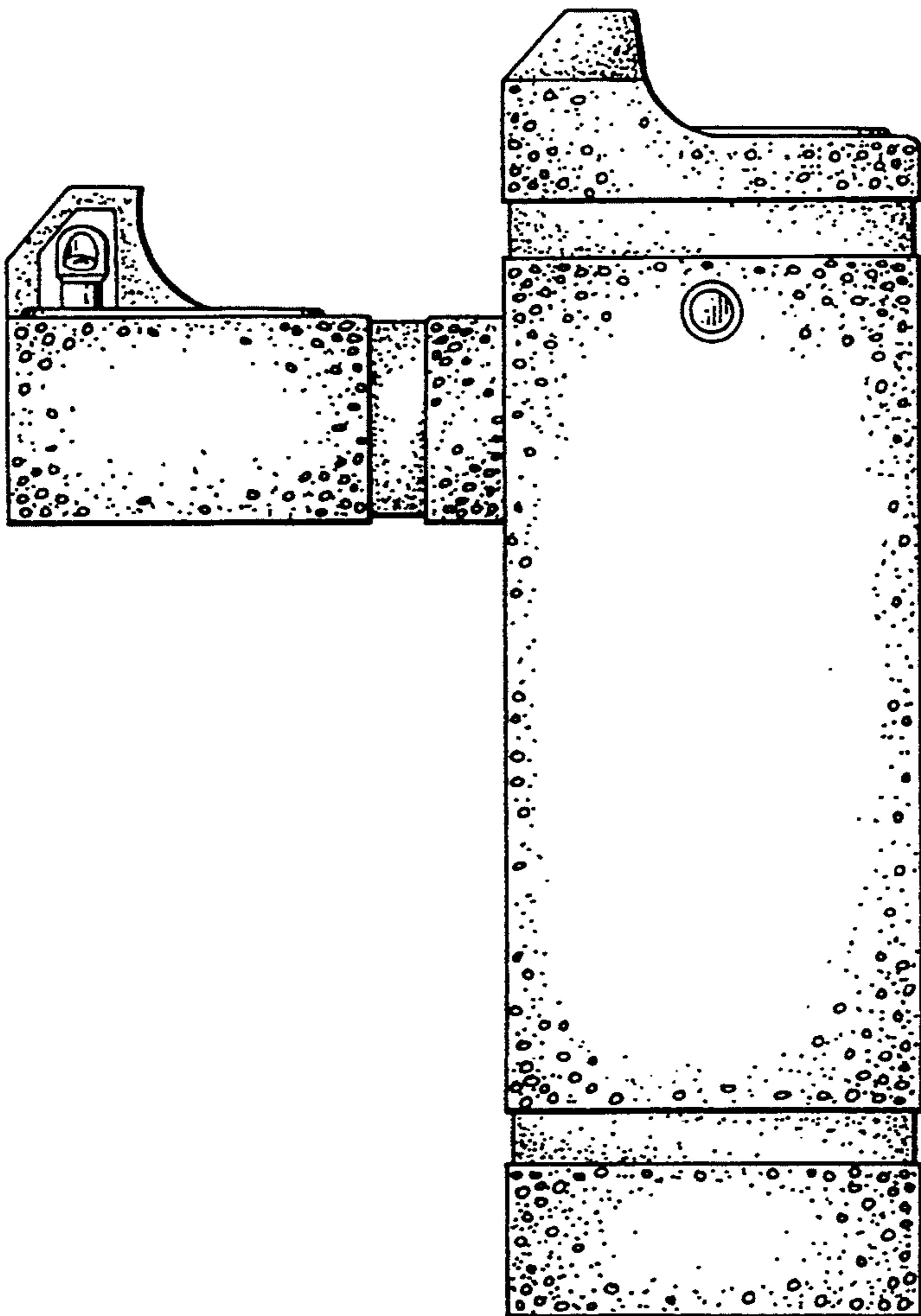
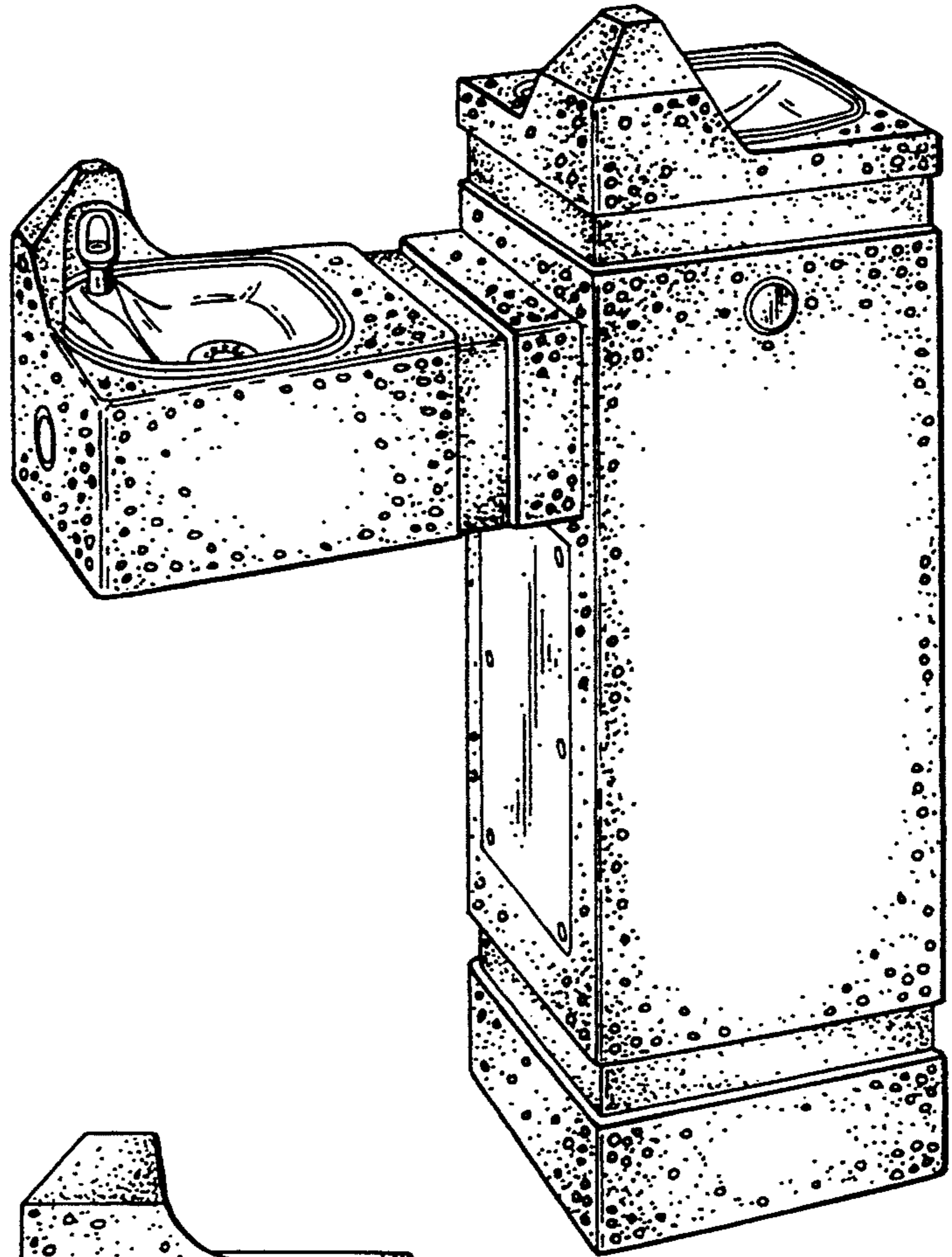

FIG. 2

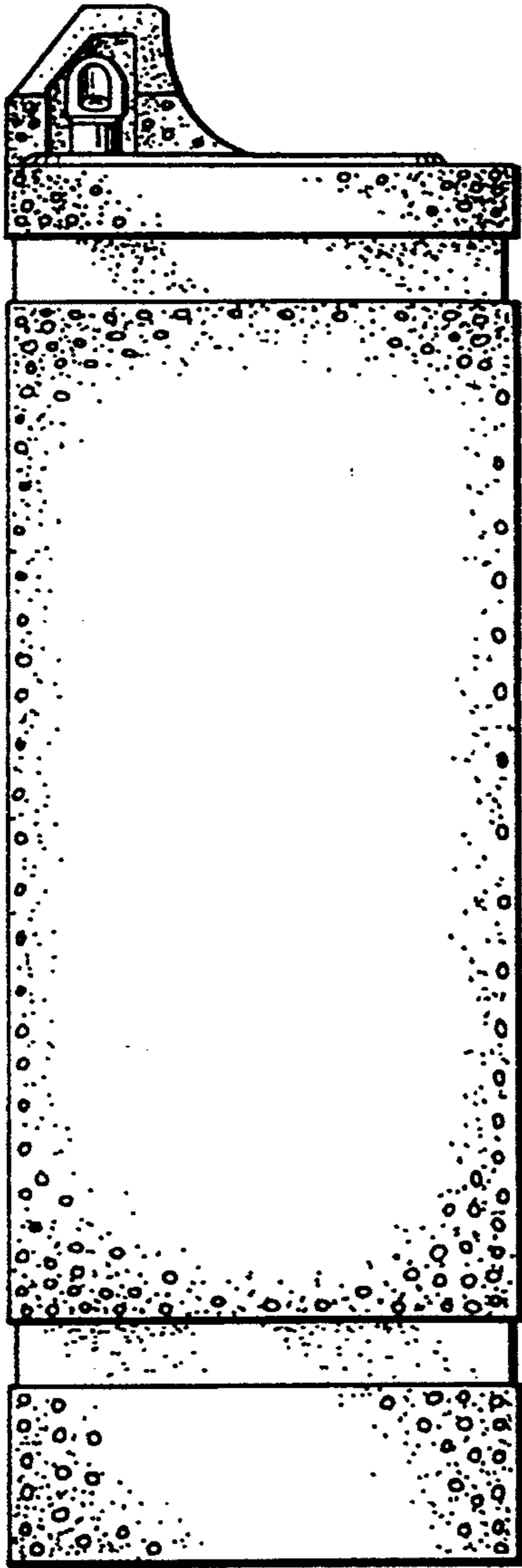

FIG. 3

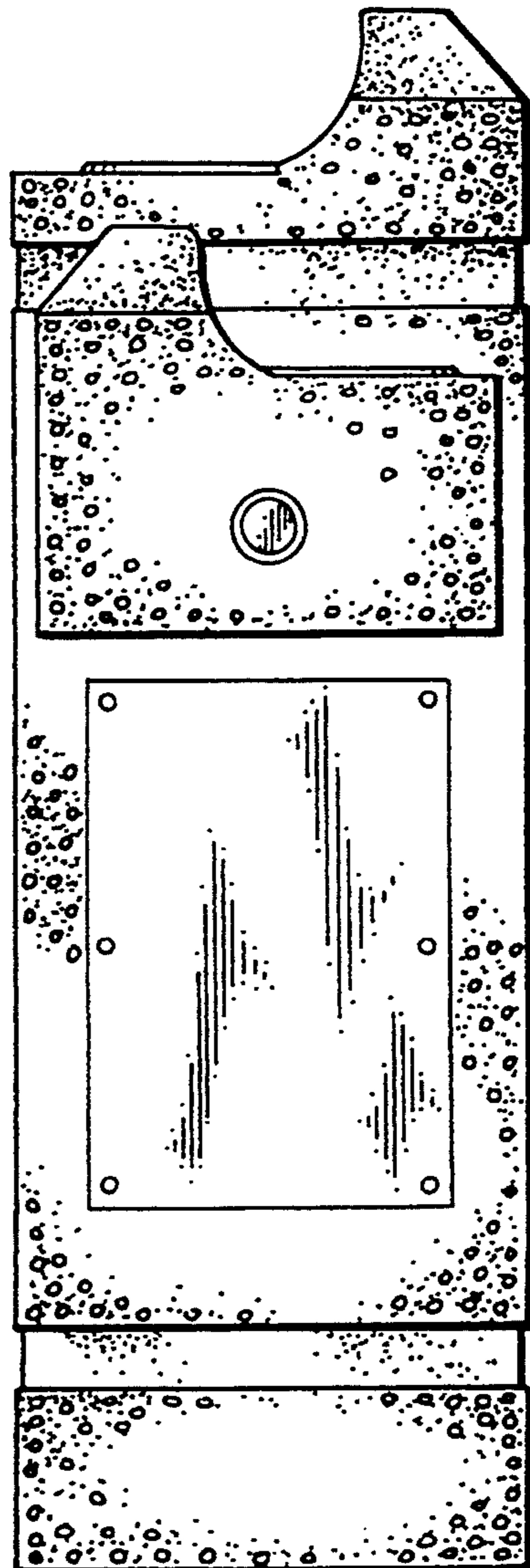

FIG. 4

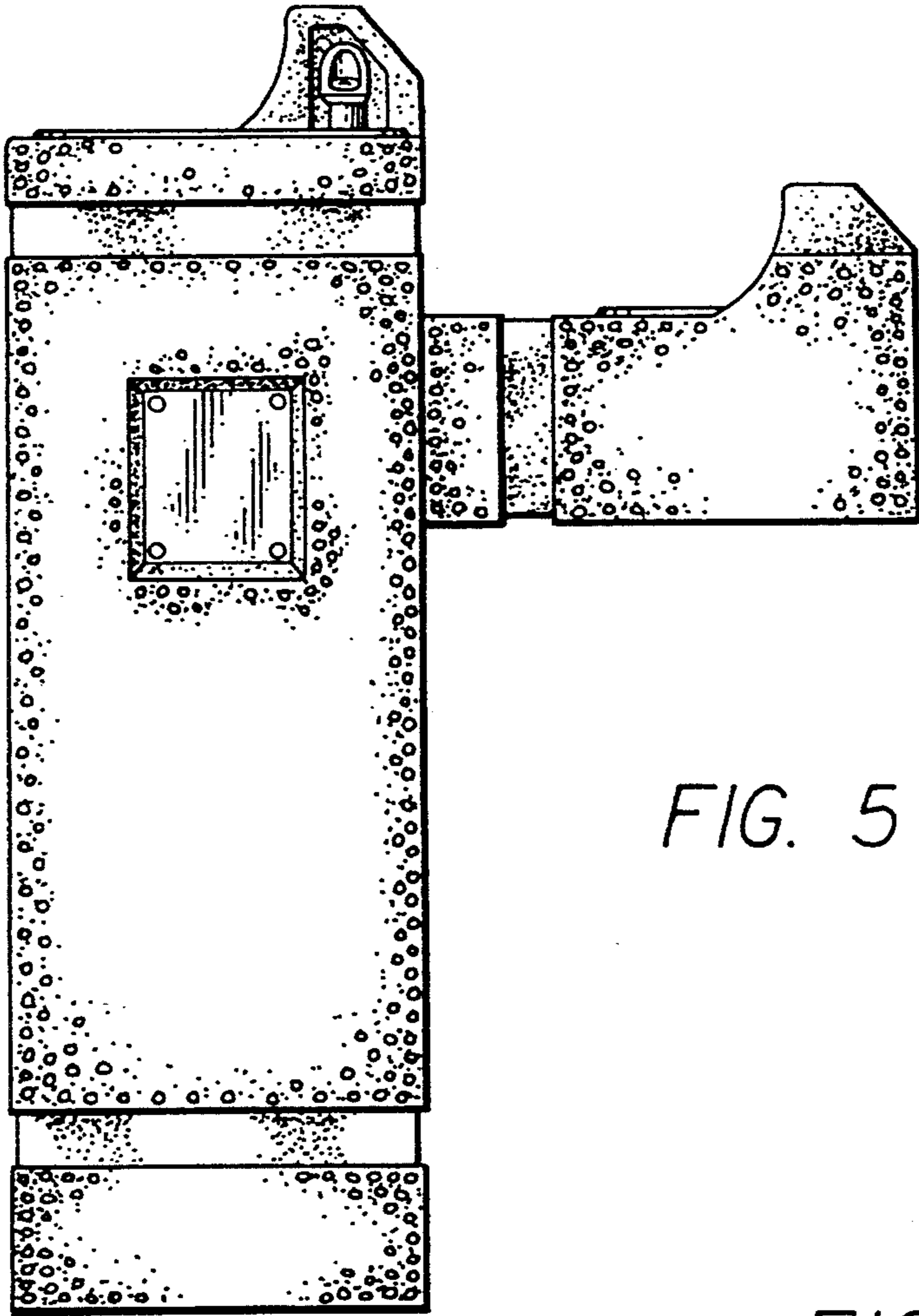

FIG. 5

FIG. 6

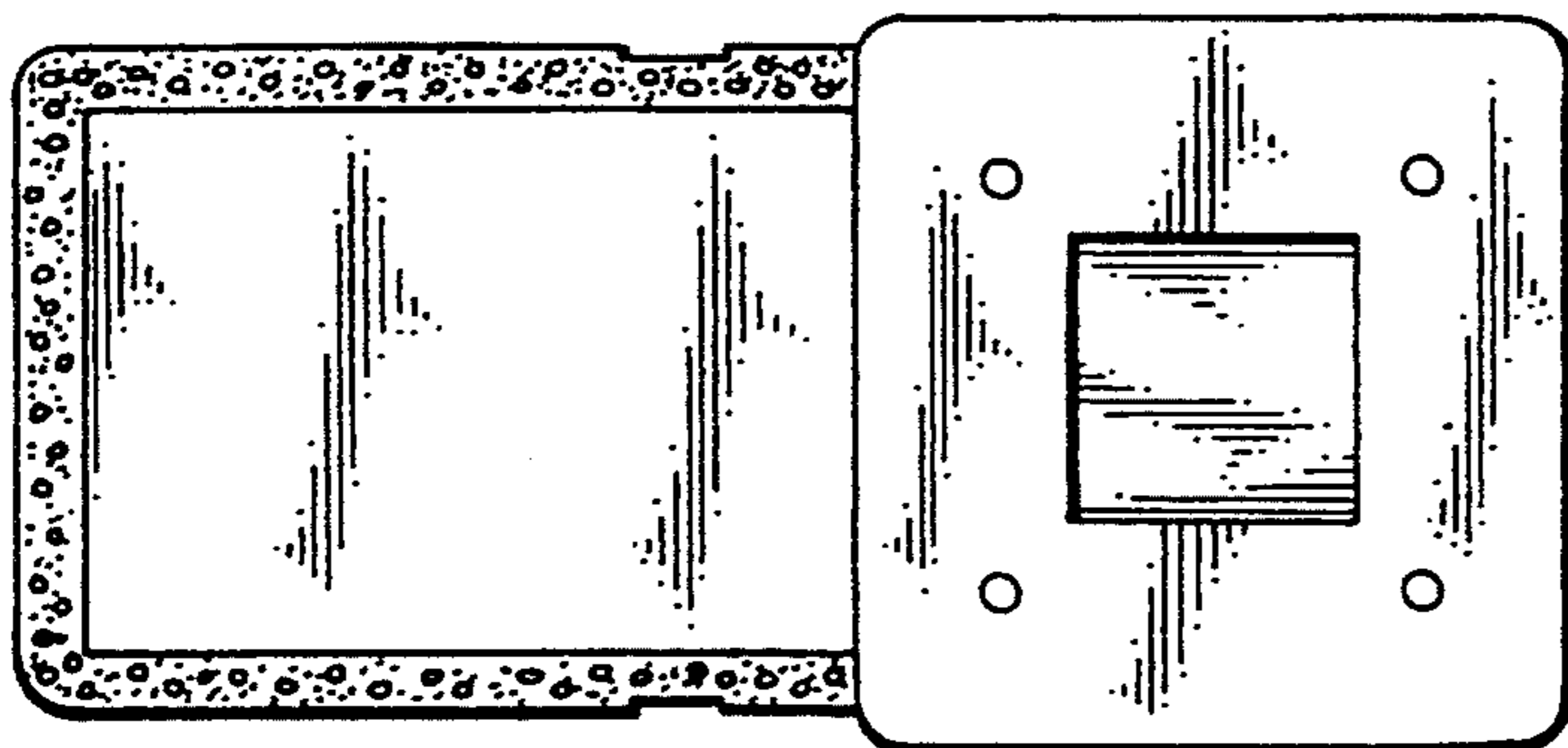
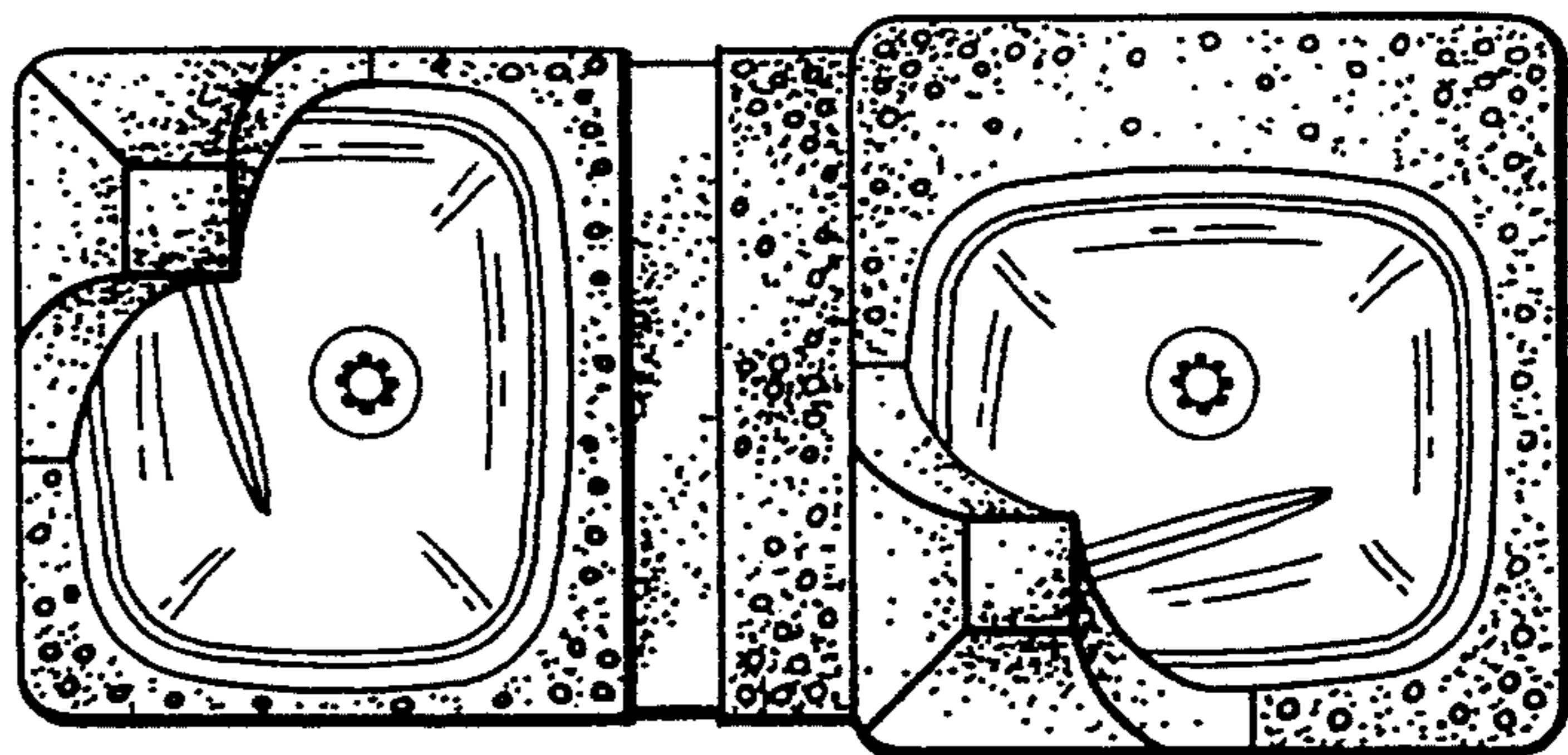

FIG. 7

FIG. 8

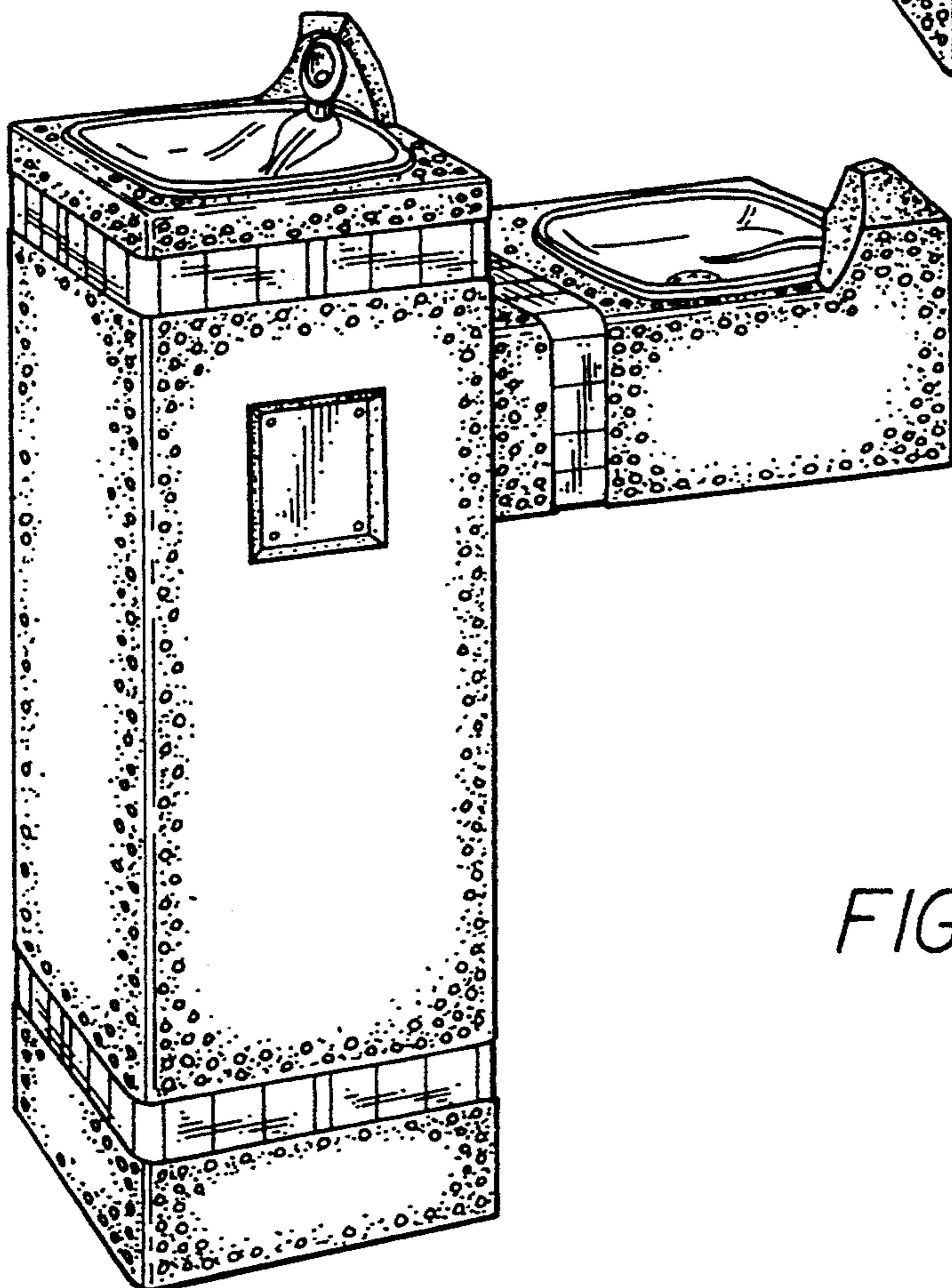
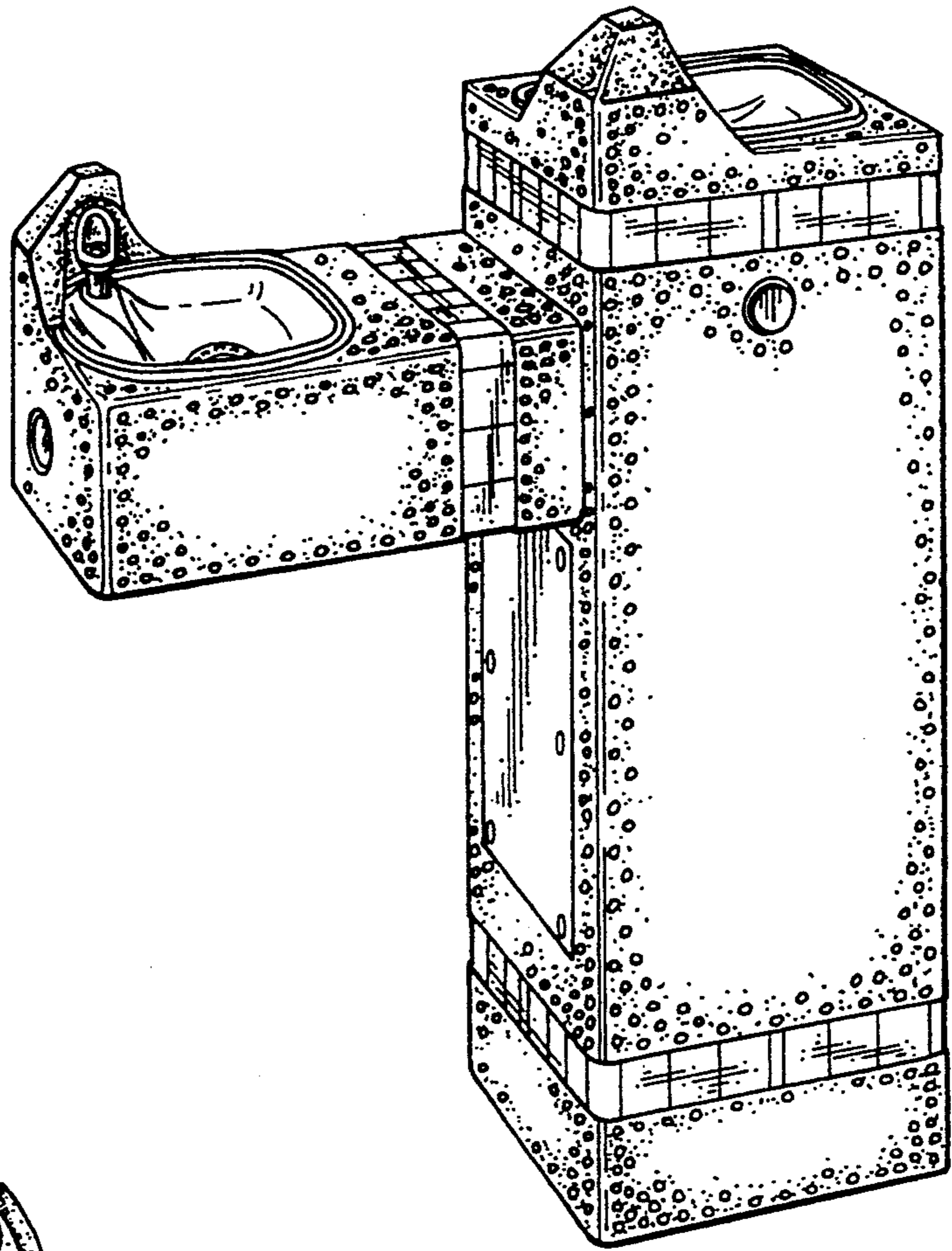

FIG. 9

FIG. 10

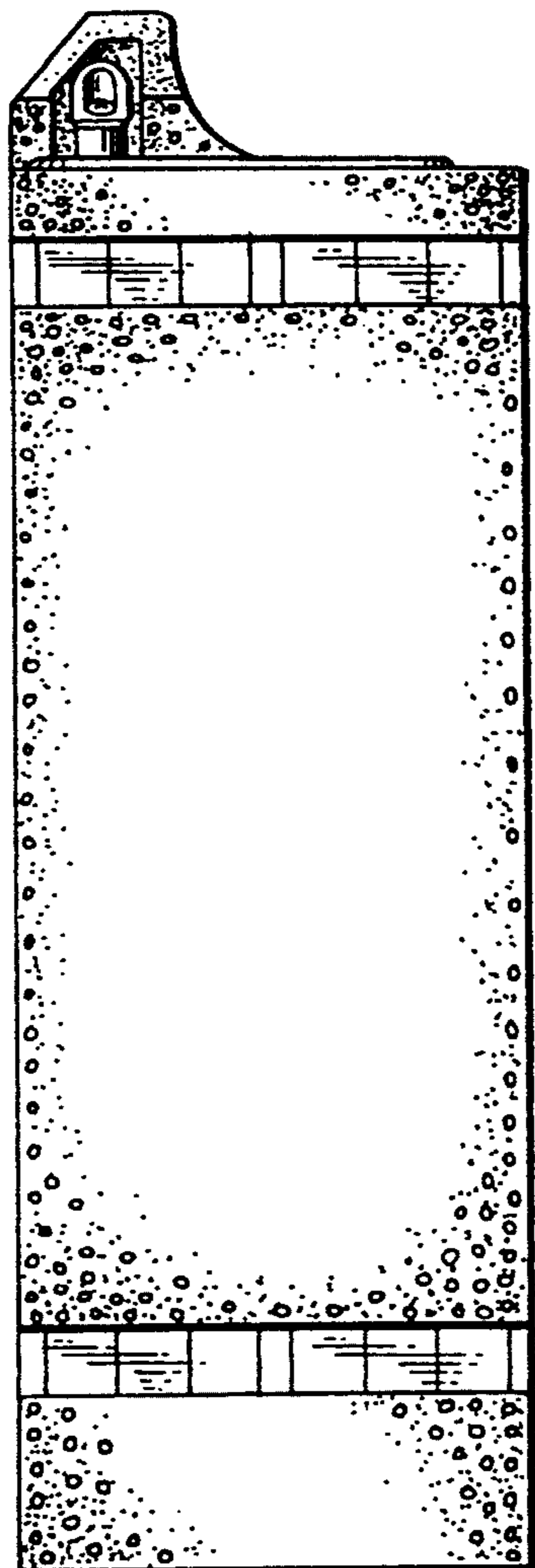
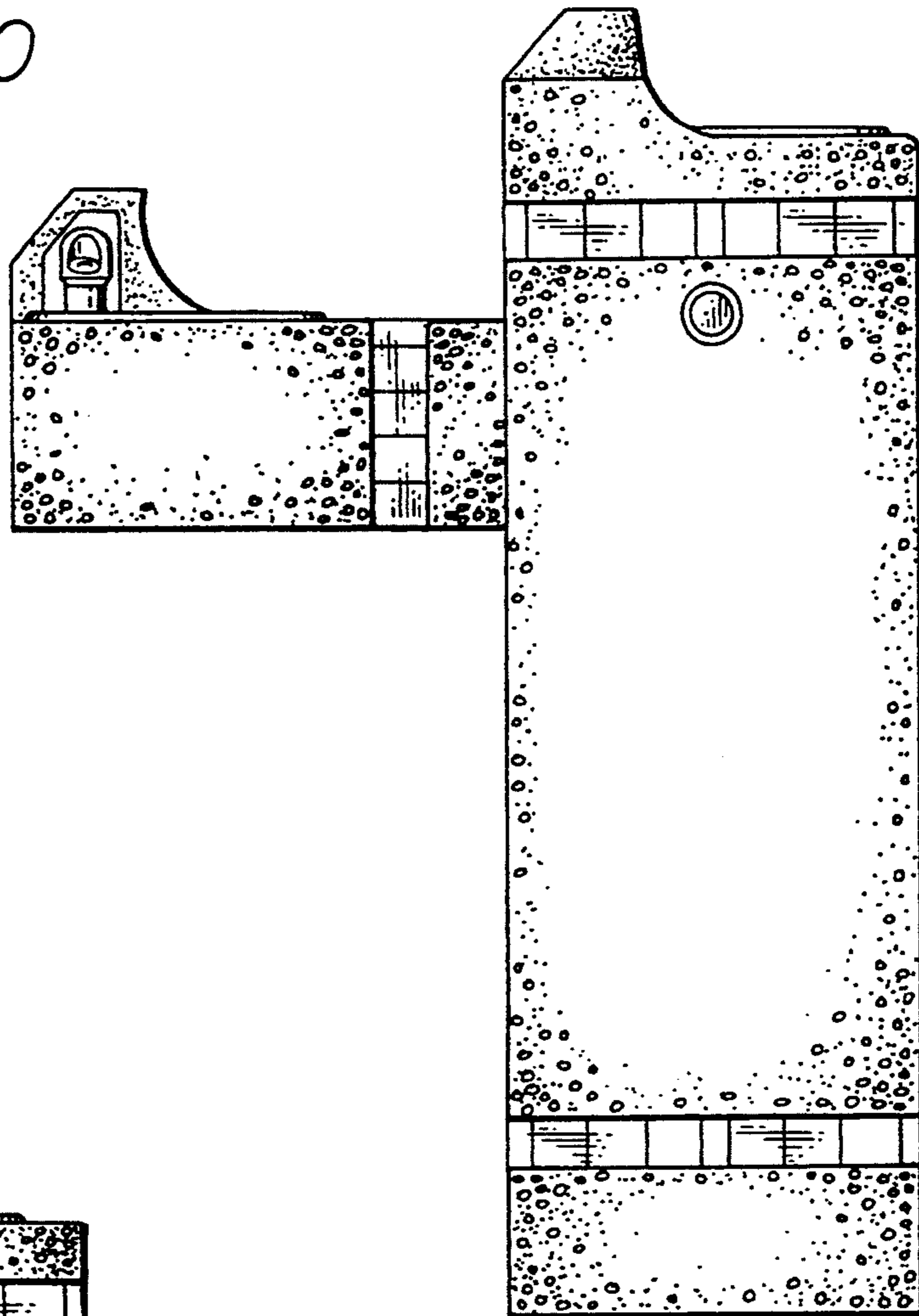

FIG. 11

FIG. 12

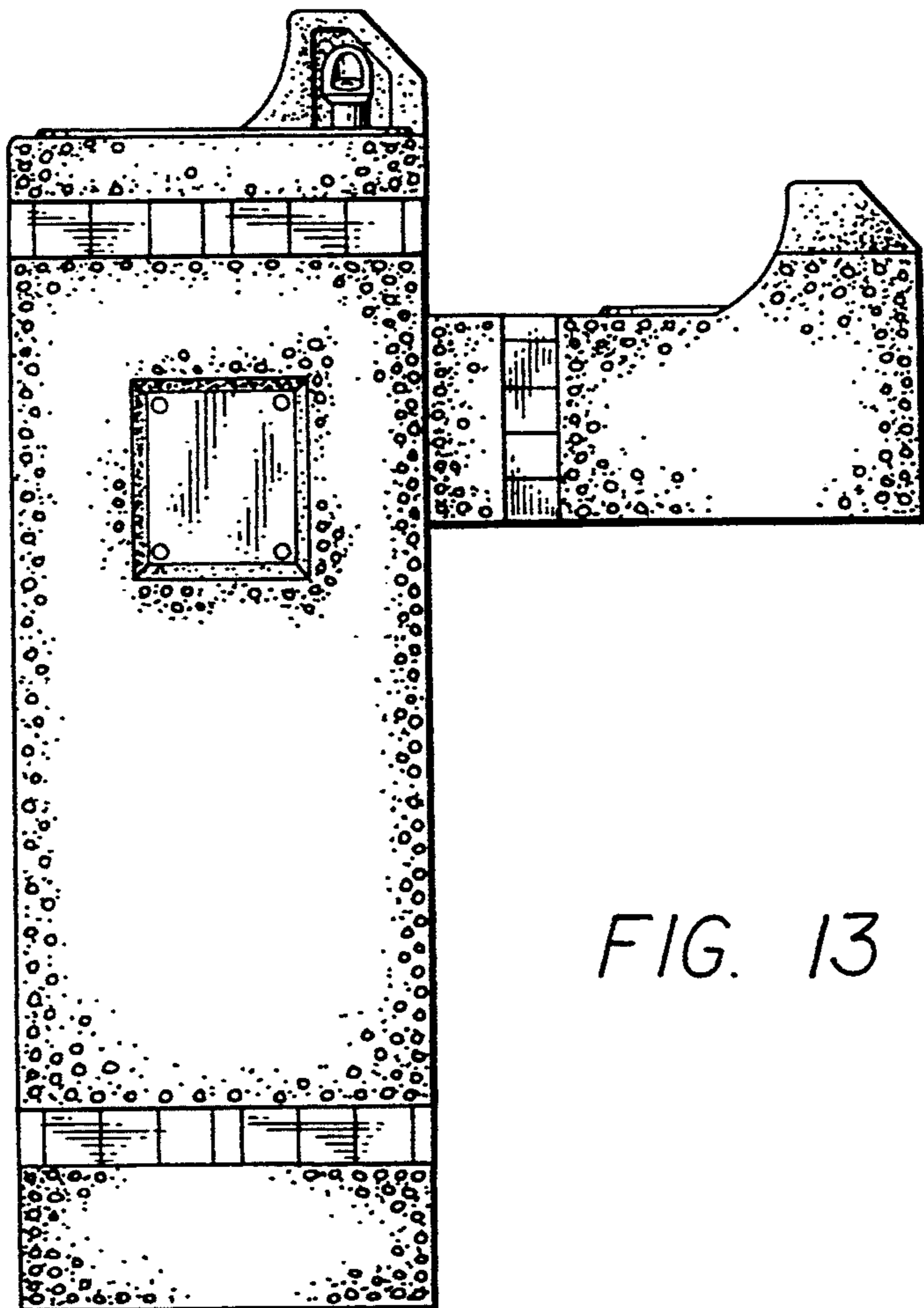
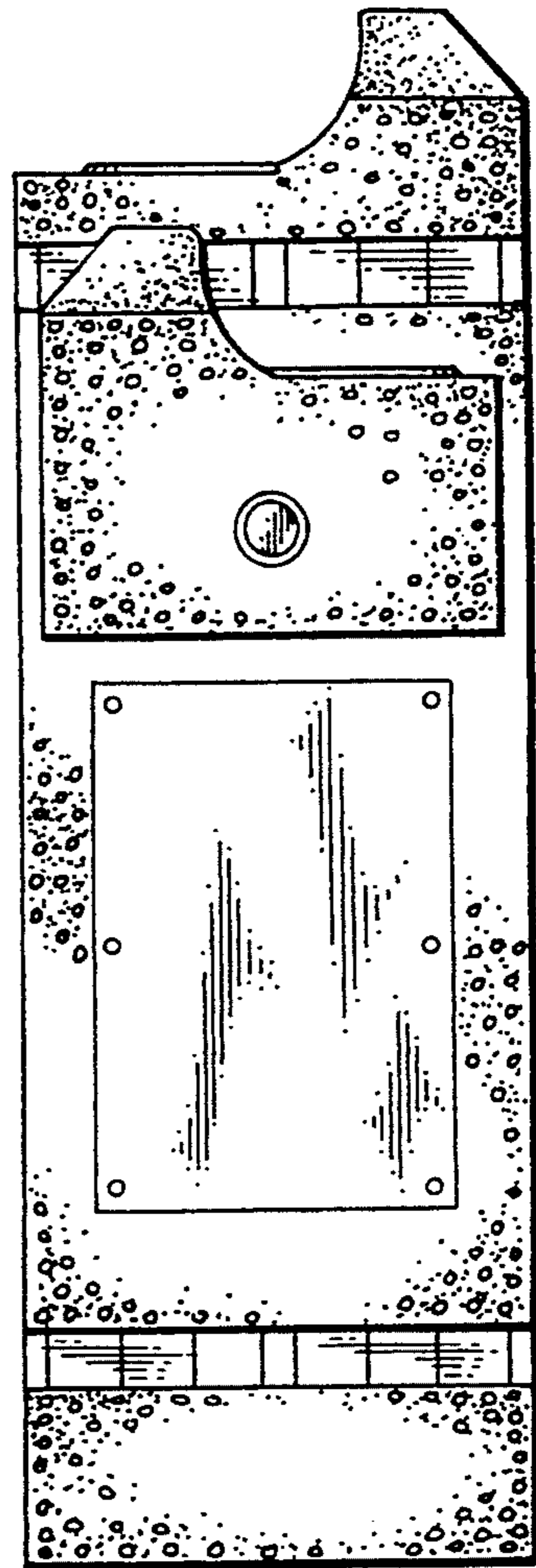

FIG. 13

FIG. 14

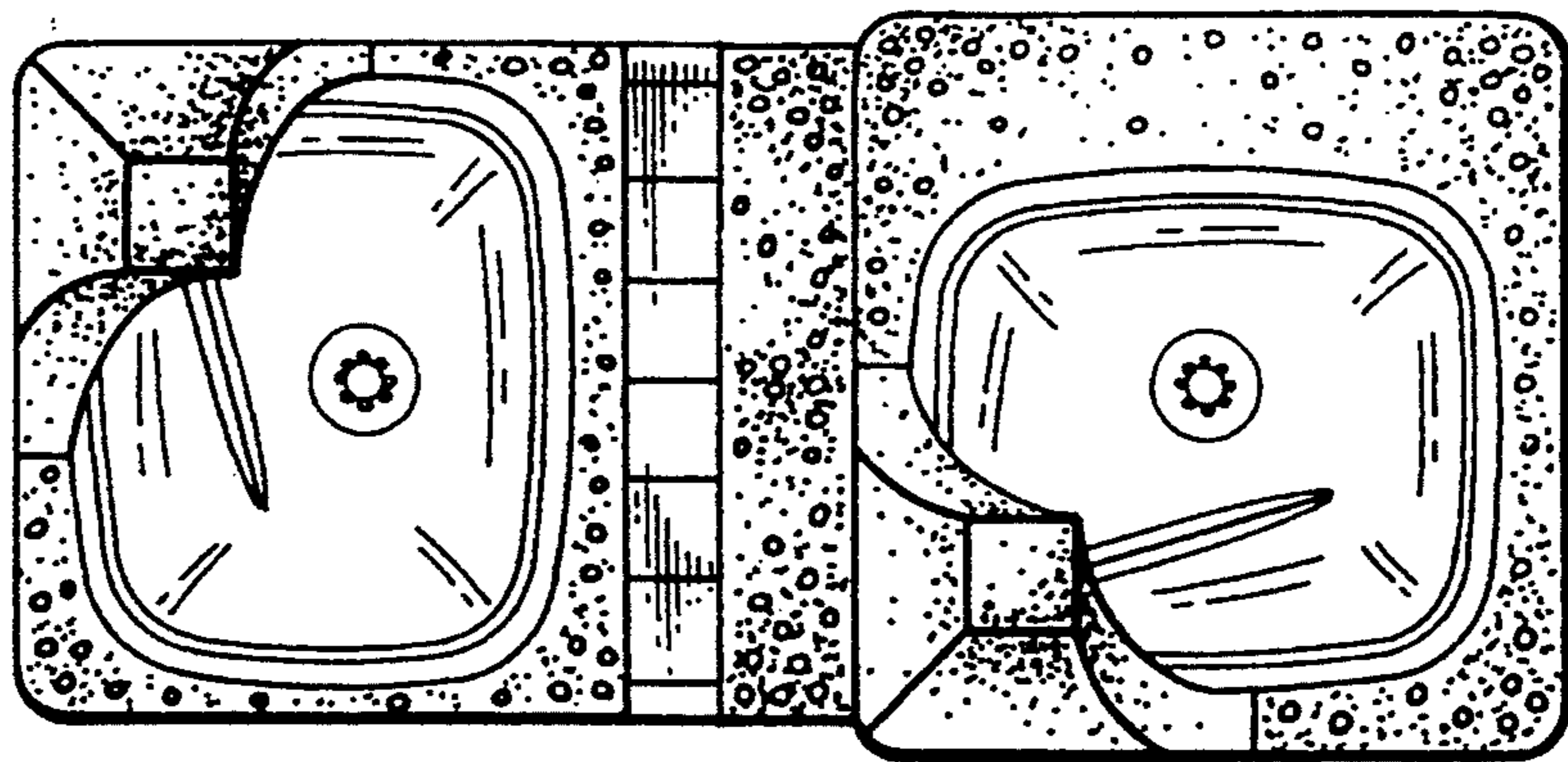
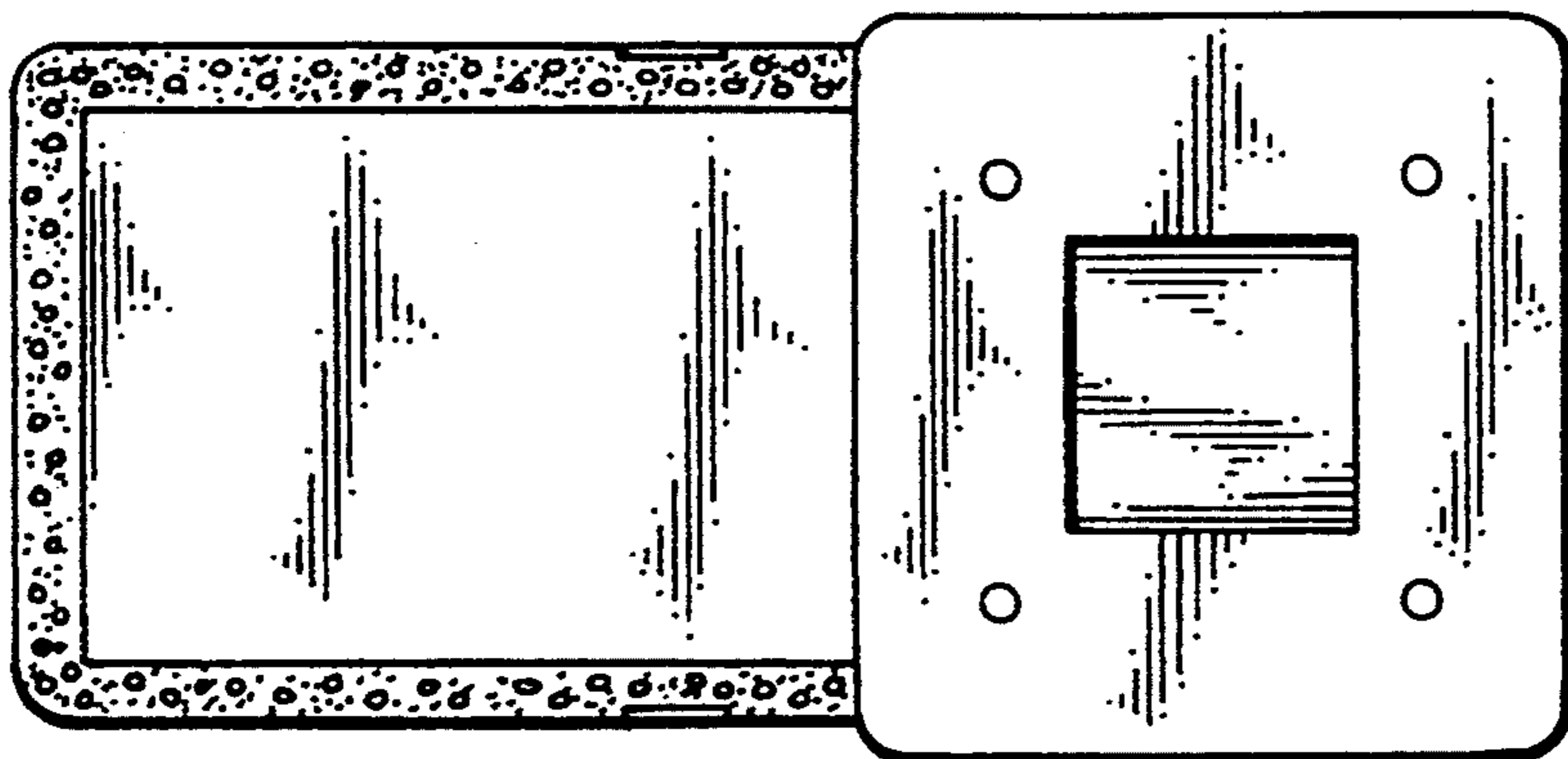

FIG. 15



UNITED STATES PATENT AND TRADEMARK OFFICE
CERTIFICATE OF CORRECTION

PATENT NO. : Des.356,229
DATED : March 14, 1995
INVENTOR(S) : Matthew I. Stein

It is certified that error appears in the above-identified patent and that said Letters Patent is hereby corrected as shown below:

On the title page, item [73]
Assignee, change "Nebr." to --Nev.--.

Signed and Sealed this
Sixth Day of June, 1995



BRUCE LEHMAN

Attest:

Attesting Officer

Commissioner of Patents and Trademarks