



US00D356193S

# United States Patent [19]

[11] Patent Number: **Des. 356,193**

Reynolds

[45] Date of Patent: **\*\* Mar. 7, 1995**

[54] **LAUNDRY ROOM DISPENSING HOPPER**

[76] Inventor: **Sylvester Reynolds, 403 Harper Rd., Atlanta, Ga. 30315**

[\*\*] Term: **14 Years**

[21] Appl. No.: **14,057**

[22] Filed: **Oct. 12, 1993**

[52] U.S. Cl. .... **D32/30**

[58] Field of Search ..... **68/17 R; 222/181, 132, 222/129; D6/542, 545; D32/25, 30**

5,143,262	9/1992	Edlund .....	222/129
5,186,359	2/1999	Brown et al. ....	222/1
5,262,132	11/1993	Bricker et al. ....	68/117 R
5,277,332	1/1994	Rogers .....	222/132

### FOREIGN PATENT DOCUMENTS

2609002	7/1988	France .....	222/132
2710195	9/1978	Germany .....	68/17 R
244585	4/1987	Germany .....	68/17 R
1-185297	7/1989	Japan .....	68/17 R
2164633	3/1986	United Kingdom .....	222/181

*Primary Examiner*—Cathy Anne MacCormac  
*Attorney, Agent, or Firm*—Hopkins & Thomas

[56] **References Cited**

#### U.S. PATENT DOCUMENTS

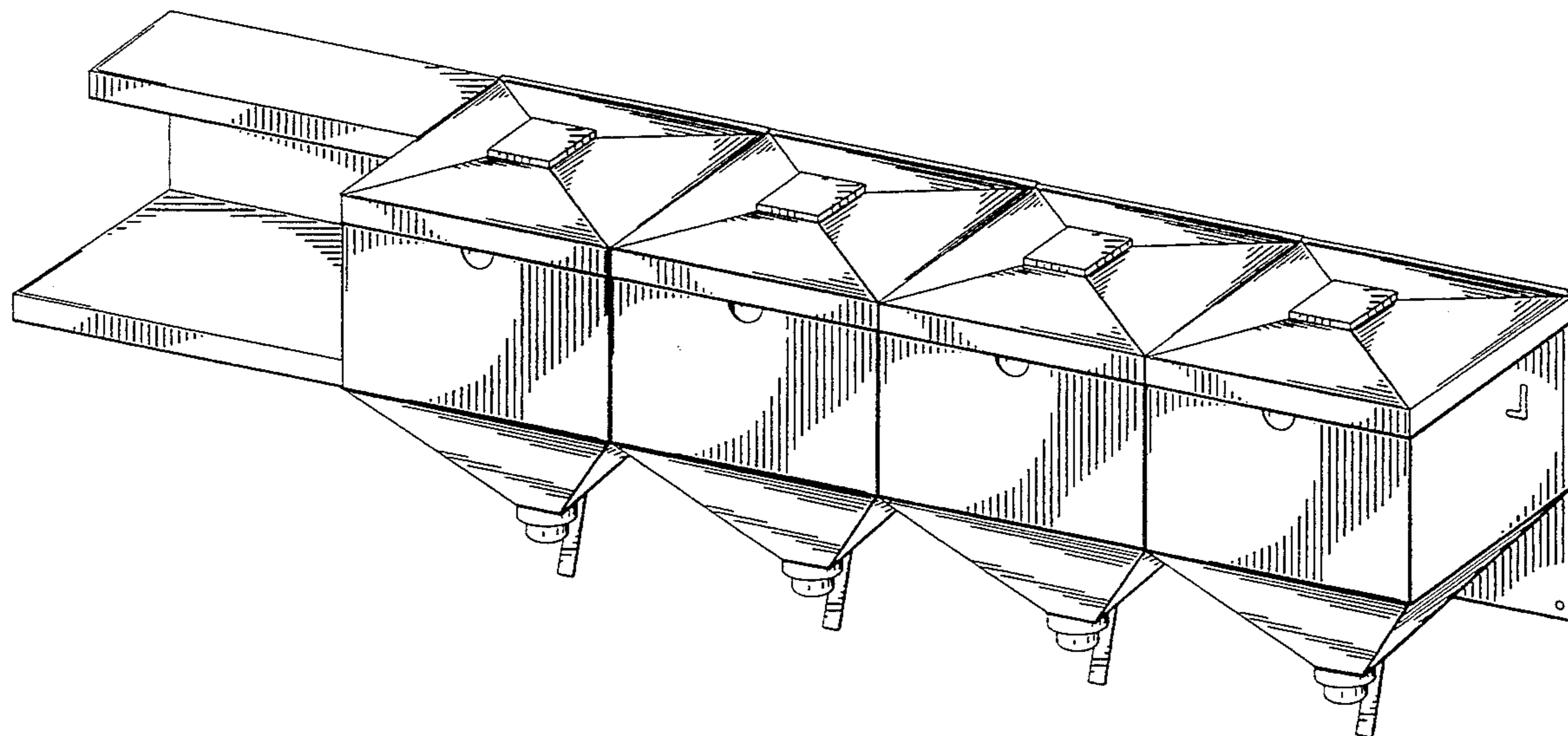
D. 265,616	8/1982	Fischer et al. ....	D6/545
D. 306,923	3/1990	Bödecker et al. ....	D32/25
D. 332,544	1/1993	Steiner et al. ....	D6/545
D. 344,166	2/1994	Jones .....	D32/30
D. 345,636	3/1994	Naporano .....	D32/30
2,793,940	5/1957	Bennett .....	68/17 R
2,948,437	8/1960	Nielsen .....	222/70
3,902,637	9/1975	Scheeler .....	222/144.5
4,287,921	9/1981	Sanford .....	222/181
4,763,494	8/1988	der Kinderen .....	68/17 R
4,856,681	8/1989	Murray .....	222/158
4,998,647	3/1991	Sharp .....	222/132

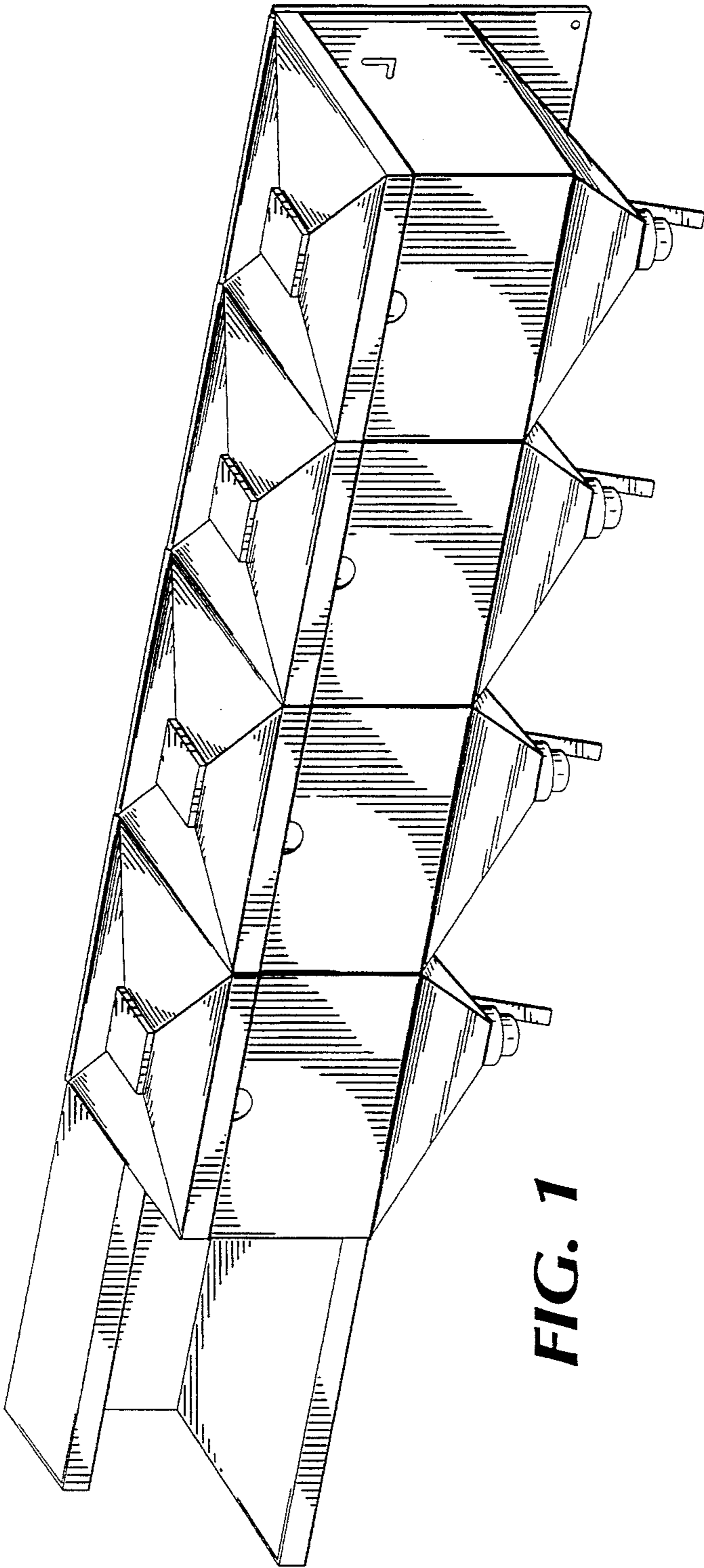
[57] **CLAIM**

The ornamental design entitled laundry room dispensing hopper, as shown and described.

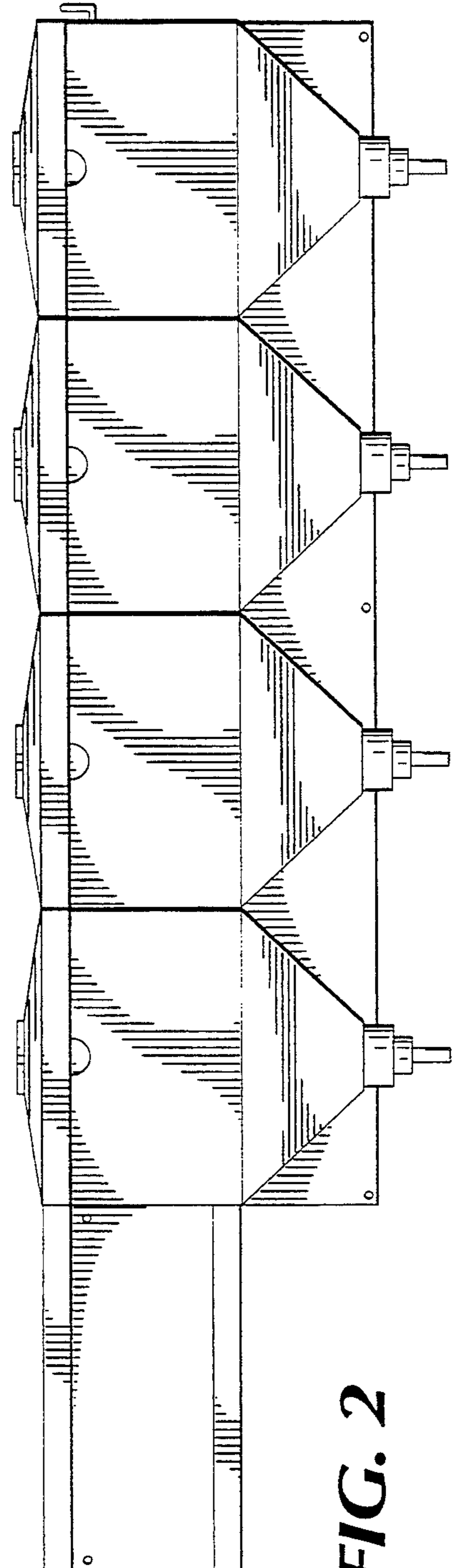
### DESCRIPTION

FIG. 1 is a perspective view of my new design for a laundry room dispensing hopper; FIG. 2 is a front view thereof; FIG. 3 is a left side view thereof; FIG. 4 is a right side view thereof; FIG. 5 is a top view thereof; and, FIG. 6 is a bottom view thereof. The rear is plain and unornamented.

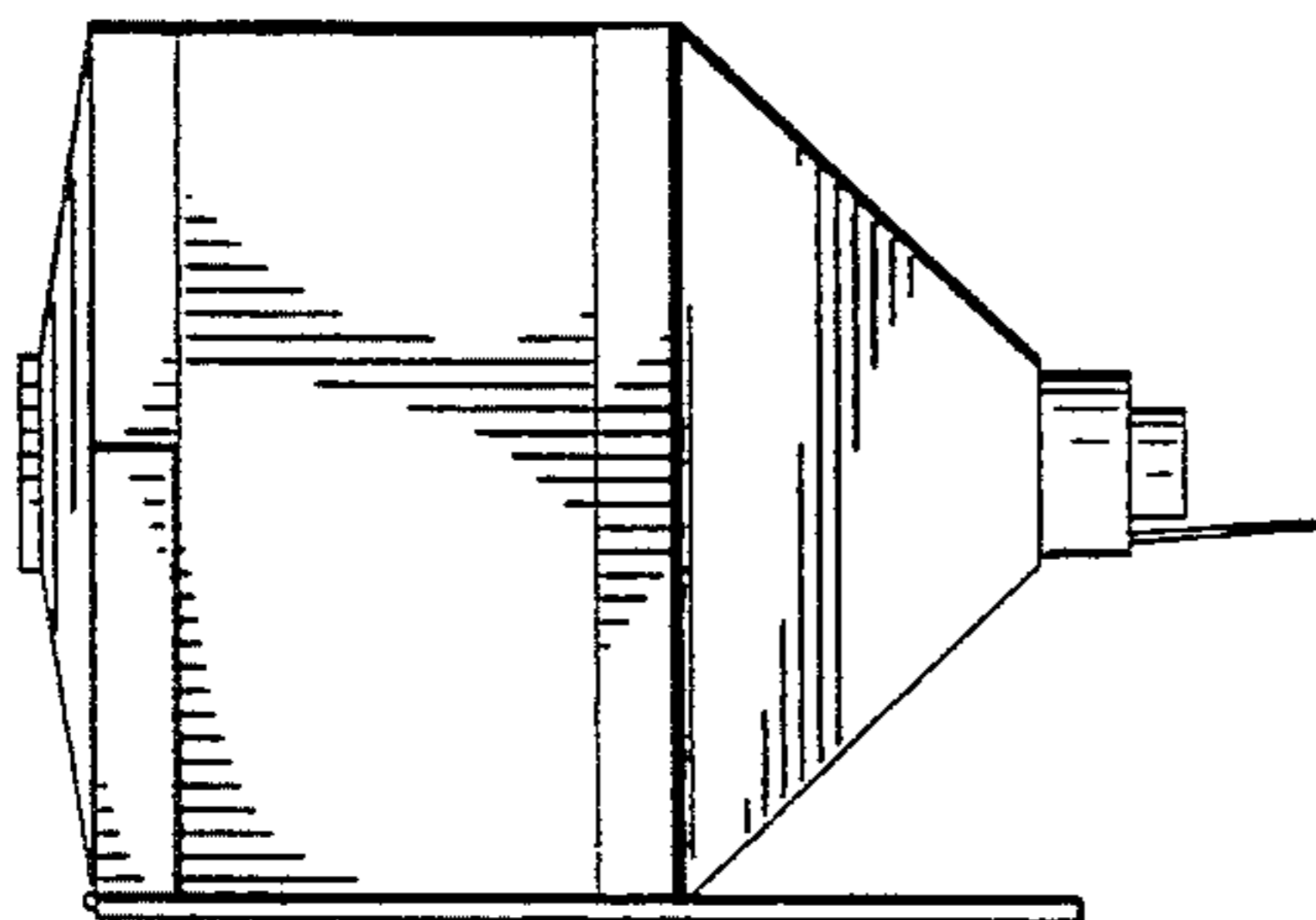




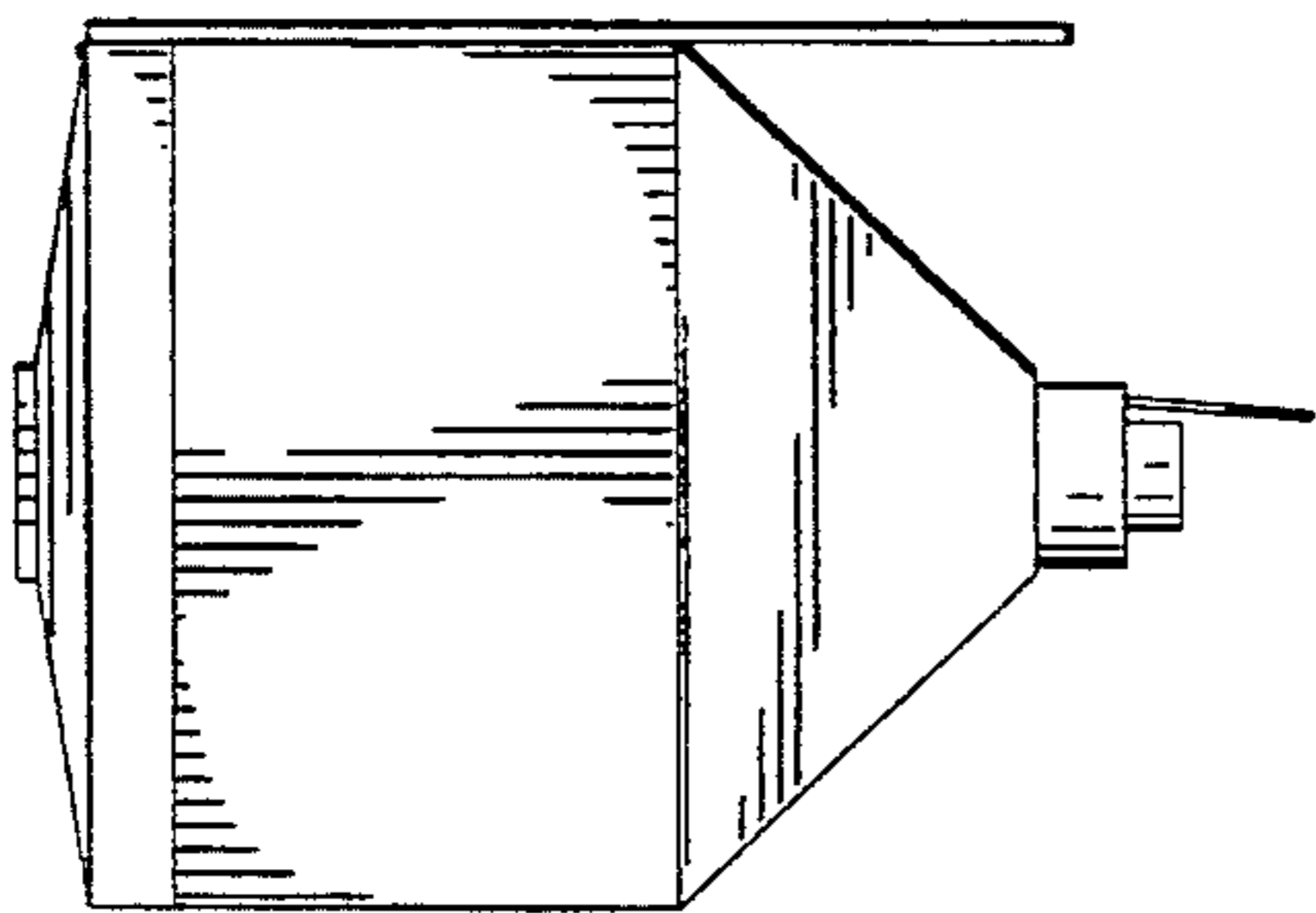
**FIG. 1**



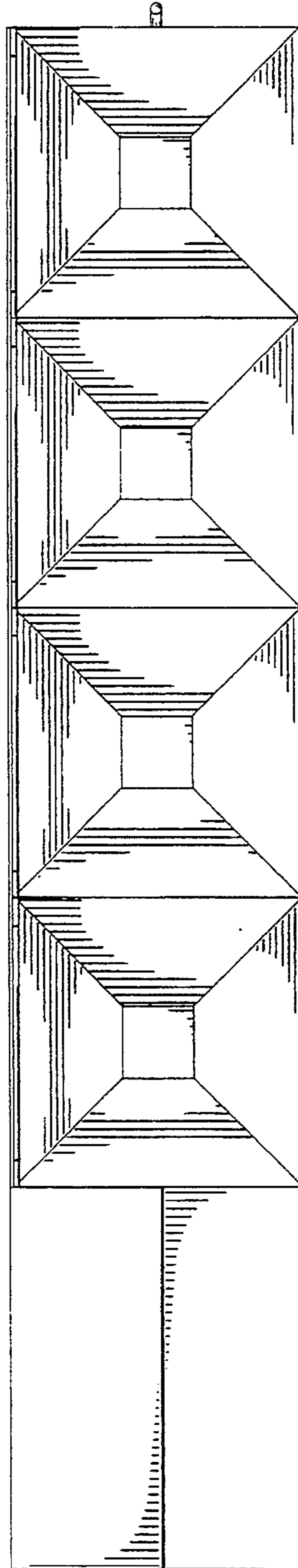
**FIG. 2**



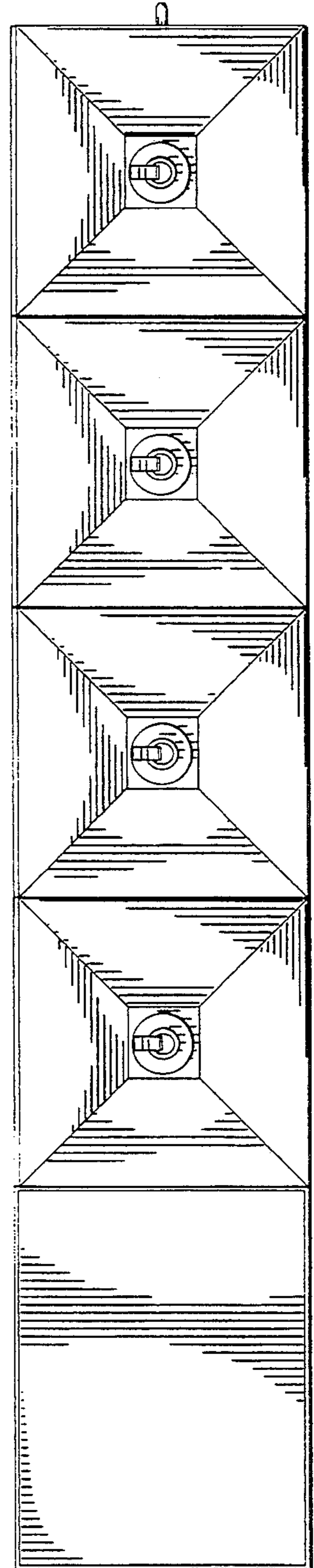
**FIG. 3**



**FIG. 4**



**FIG. 5**



**FIG. 6**