



US00D356113S

United States Patent [19]

[11] Patent Number: **Des. 356,113**

Maggio

[45] Date of Patent: **** Mar. 7, 1995**

[54] **COMBINED WRITING INSTRUMENT AND HEMP LEAF POCKET CLIP**

[76] Inventor: **John J. Maggio**, 2464 El Camino Real, #3, Santa Clara, Calif. 95051

[**] Term: **14 Years**

[21] Appl. No.: **25,121**

[22] Filed: **Jun. 27, 1994**

[63] Continuation-in-part of Des. Ser. No. 10,421, filed Jul. 6, 1993, abandoned.

[52] U.S. Cl. **D19/36; D19/42; D19/51; D19/56; D19/57**

[58] Field of Search **D19/35, 36, 41, 42, D19/43-51, 54-58, 81-85; 401/52, 195, 243-247**

[56] **References Cited**

U.S. PATENT DOCUMENTS

D. 73,781	11/1927	Felger	D19/42
D. 145,431	8/1946	Flanagan	D19/42
D. 222,566	11/1971	Dunn	D19/82 X
D. 326,868	6/1992	Nitta	D19/43 X
D. 330,046	10/1992	Cuadrado	D19/51 X
D. 331,777	12/1992	Sedlmeier et al.	D19/46 X
D. 345,175	3/1994	Giralt	D19/42
1,271,430	7/1918	Bush	401/195 X
2,358,791	9/1944	Collopy et al.	401/195 X
2,591,874	4/1952	Richie	401/195 X
3,343,293	9/1967	Kirklen	401/195 X
4,541,630	9/1985	Dirks	401/195 X
5,007,756	4/1991	Wey	401/52 X

OTHER PUBLICATIONS

Photocopy of ball-point pen filled with shredded money.

Photocopy of ball-point pen.

Primary Examiner—Martie Thompson
Attorney, Agent, or Firm—Flehr, Hohbach, Test, Albritton & Herbert

[57] **CLAIM**

The ornamental design for a combined writing instrument and hemp leaf pocket clip, as shown and described.

DESCRIPTION

FIG. 1 is an isometric view of a combined writing instrument and hemp leaf pocket clip showing my new design;

FIG. 2 is a front elevation view thereof;

FIG. 3 is a right side elevation view;

FIG. 4 is a left side elevation view;

FIG. 5 is a rear elevation view thereof;

FIG. 6 is a top view thereof;

FIG. 7 is a bottom view thereof;

FIG. 8 is an isometric view with the cap member in a stored position and the writing tip exposed;

FIG. 9 is a front elevation view of FIG. 8;

FIG. 10 is a right side elevation view of FIG. 8;

FIG. 11 is a left side elevation view of FIG. 8;

FIG. 12 is a rear elevation view of FIG. 8;

FIG. 13 is a top plan view of FIG. 8; and,

FIG. 14 is a bottom plan view of FIG. 8.

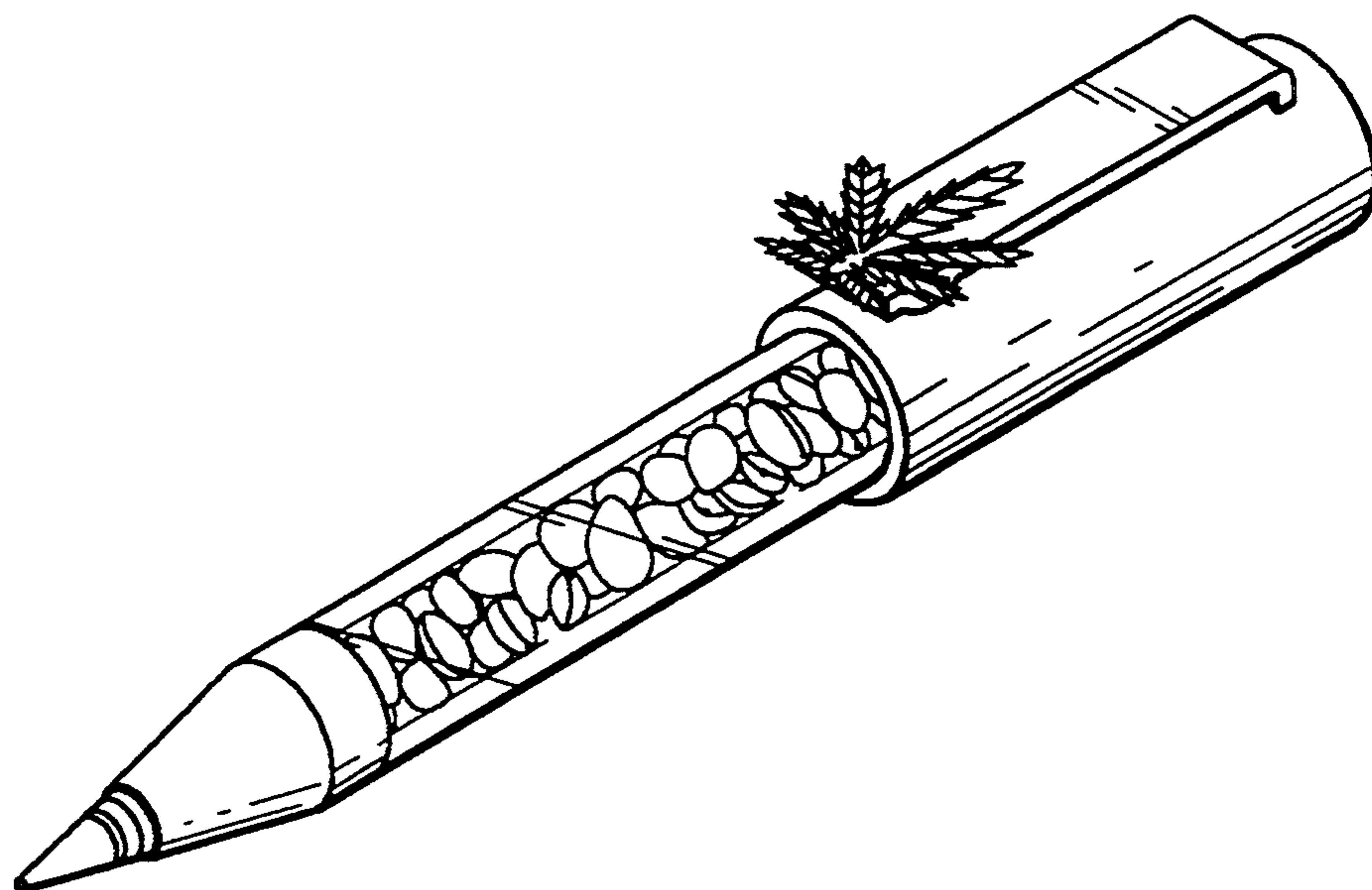

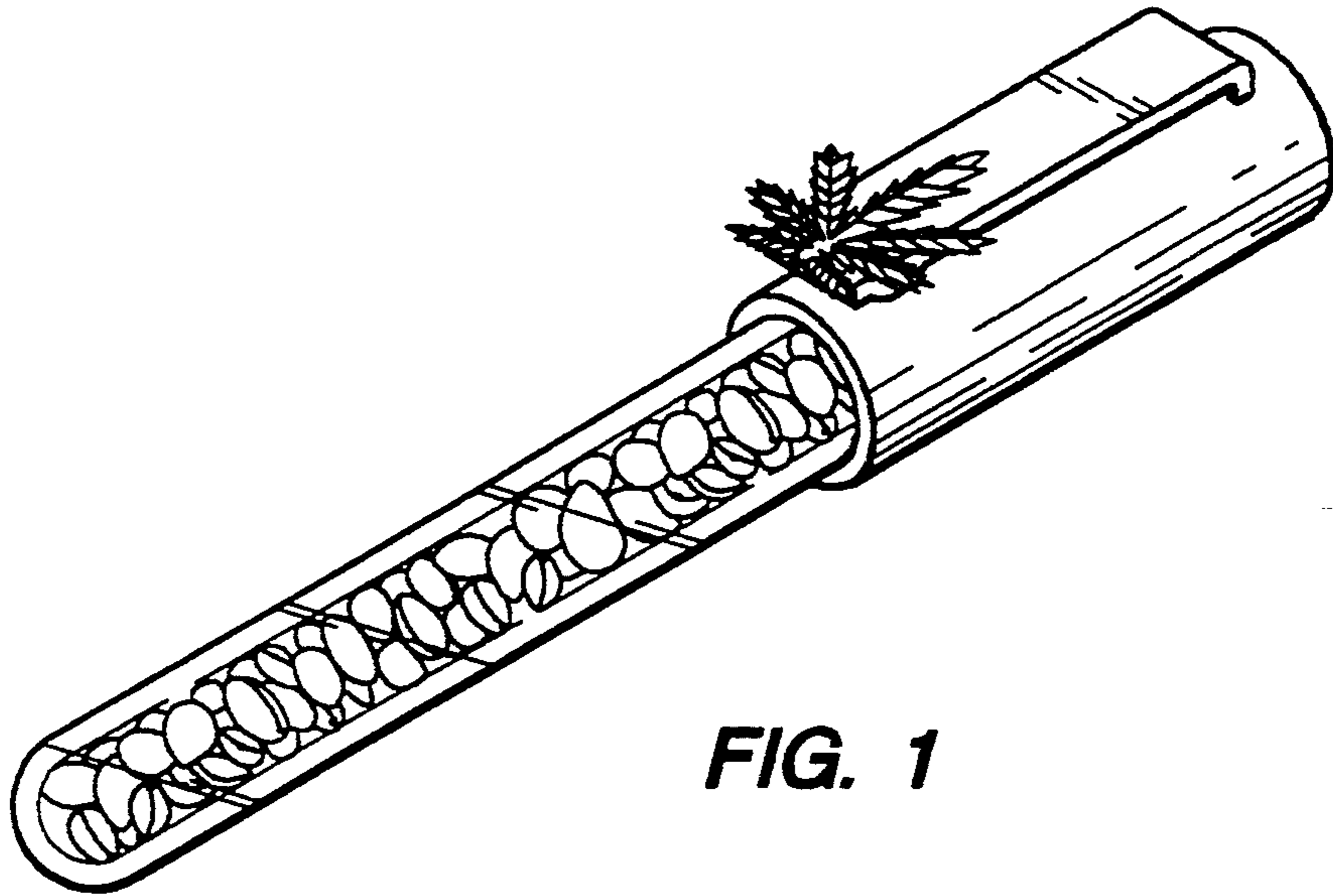

FIG. 1

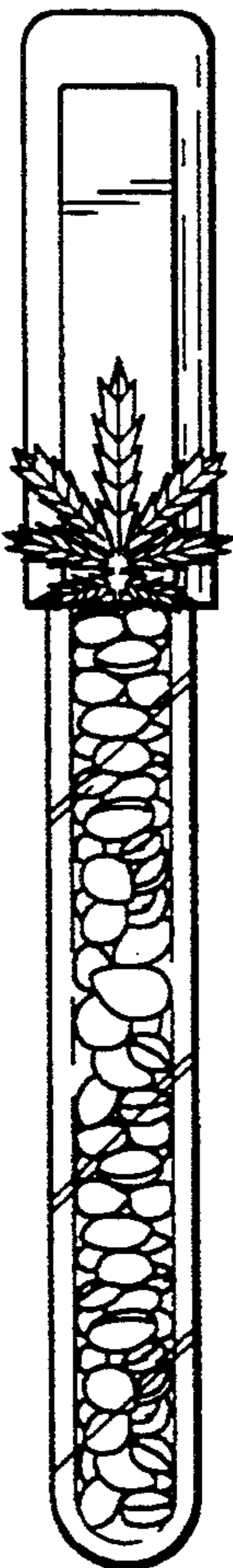

FIG. 2

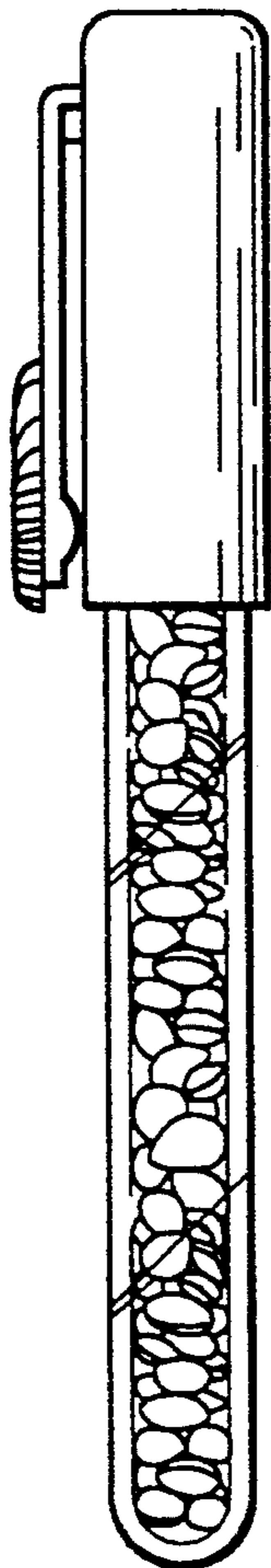

FIG. 3

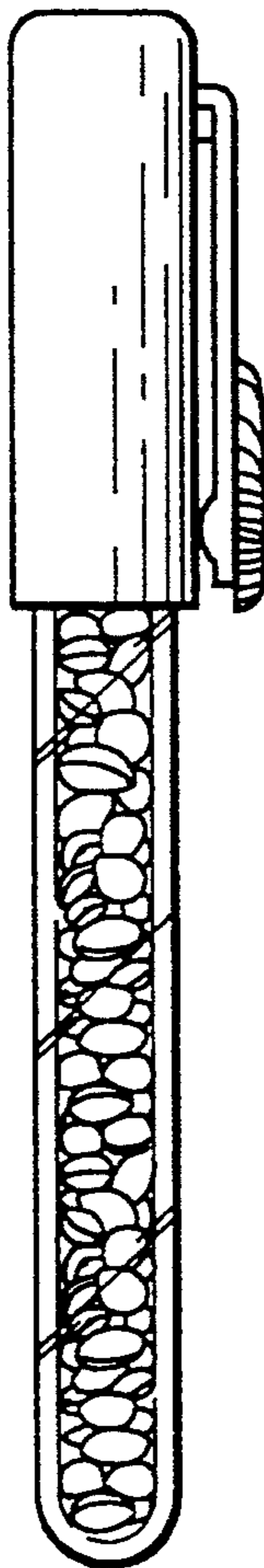

FIG. 4

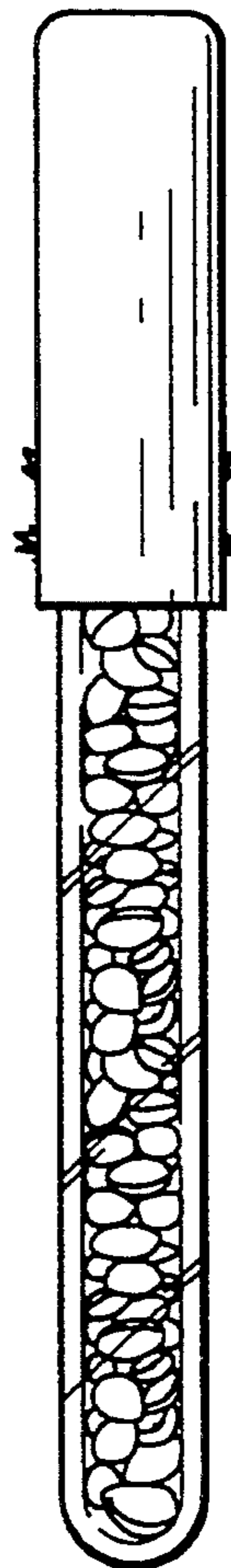

FIG. 5

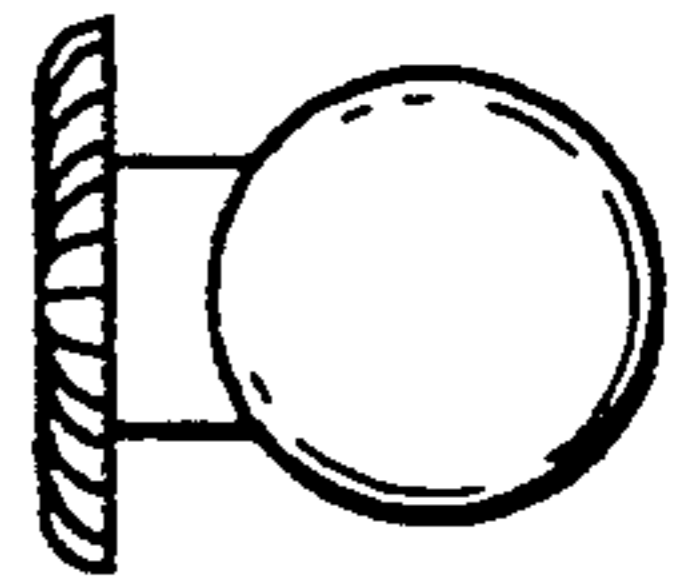

FIG. 6

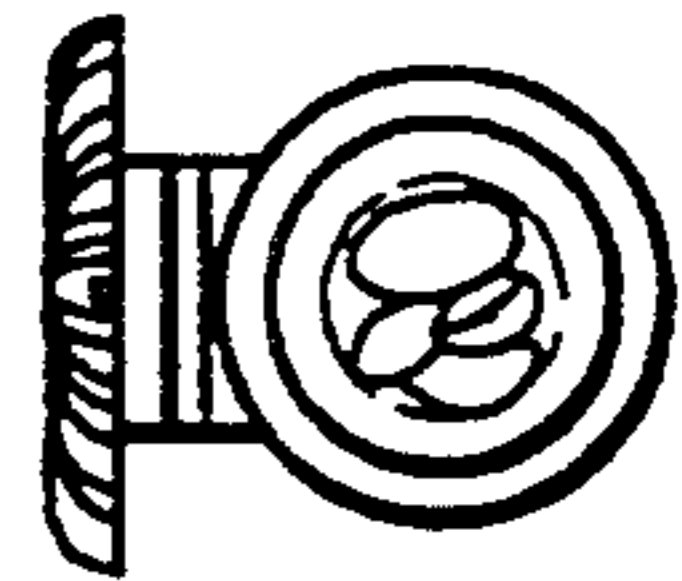

FIG. 7

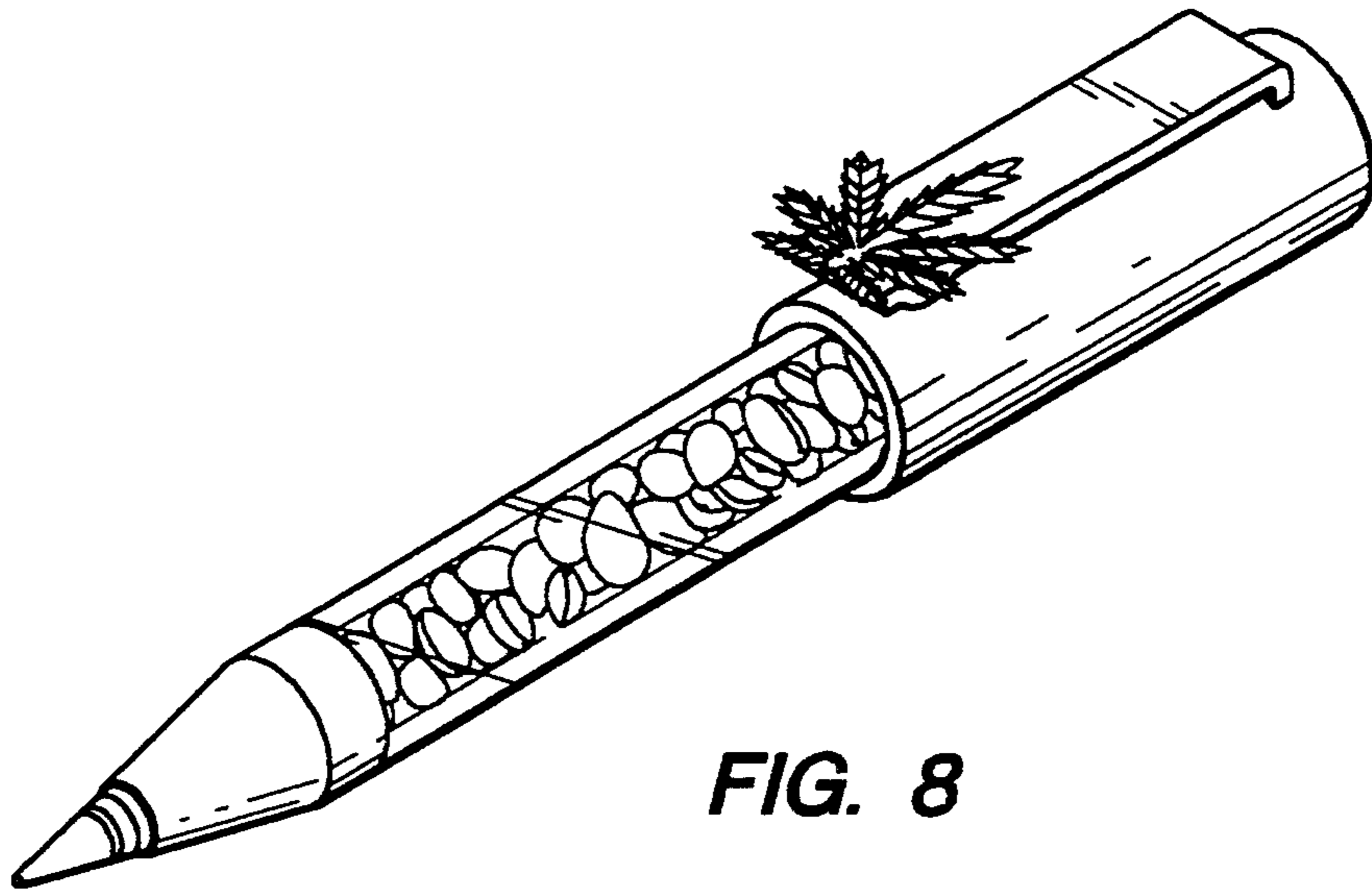

FIG. 8

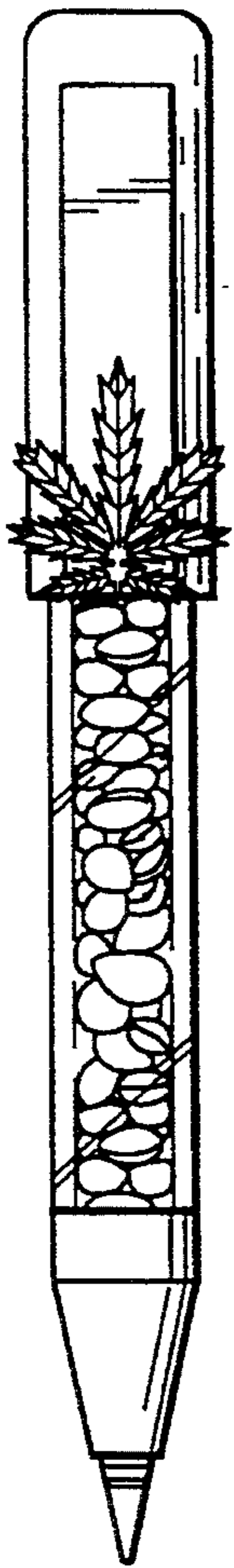

FIG. 9

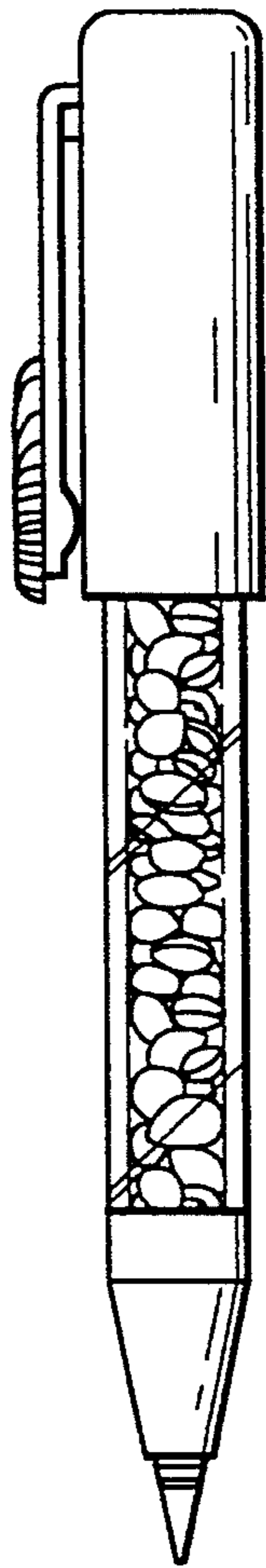

FIG. 10

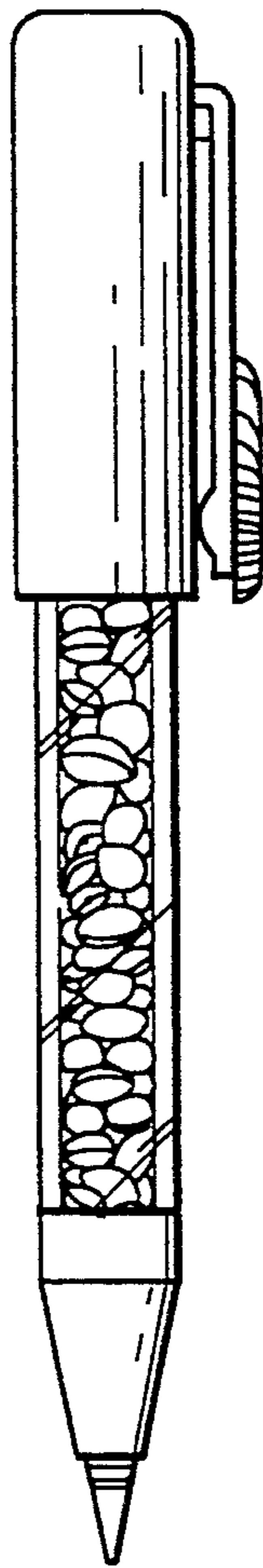

FIG. 11

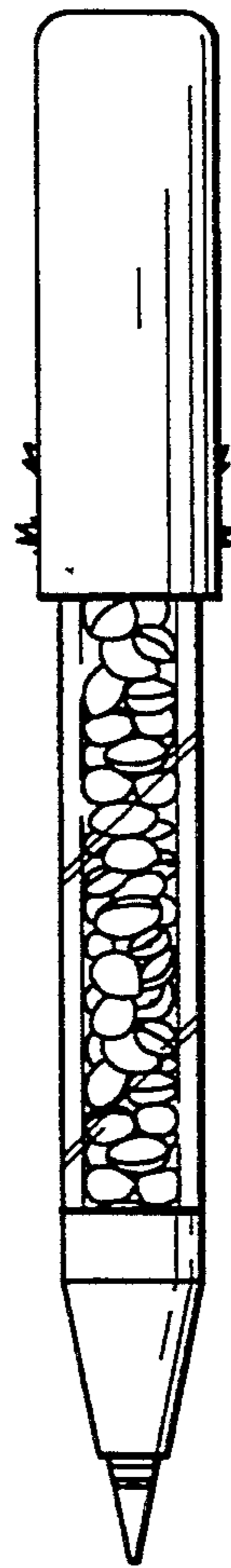

FIG. 12

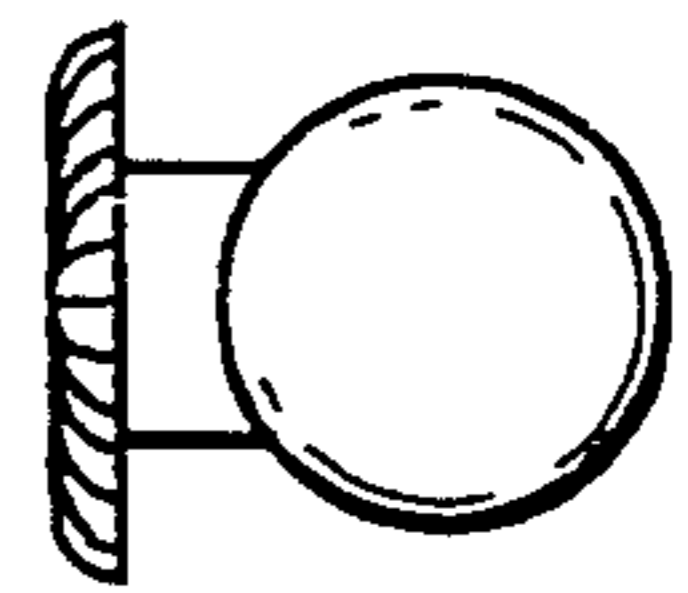

FIG. 13

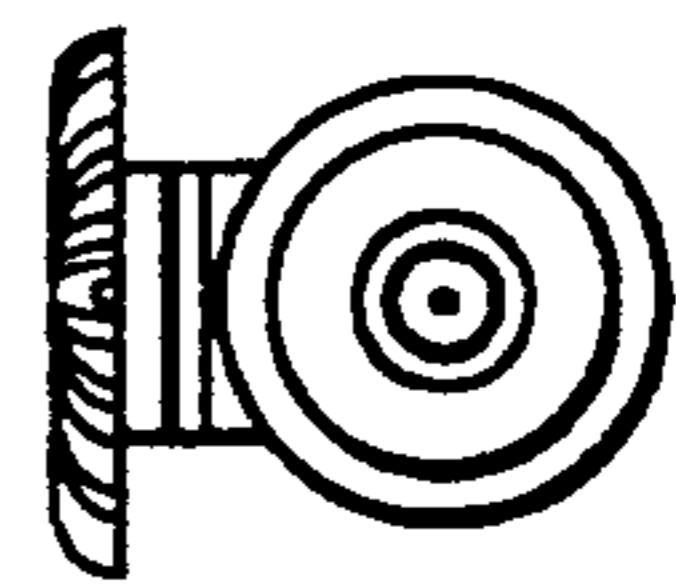

FIG. 14