



US00D356092S

United States Patent [19]

[11] Patent Number: **Des. 356,092**

McCauley et al.

[45] Date of Patent: **** Mar. 7, 1995**

[54] **FRONT PANEL FOR A COMBINED RADIO AND CASSETTE TAPE PLAYER**

[56] **References Cited**

U.S. PATENT DOCUMENTS

[75] Inventors: **Gilbert L. McCauley, Oak Park;**
James P. Muccioli, Farmington Hills;
Lee M. Dziekan, East Detroit, all of Mich.

D. 308,384	6/1990	Van Hout et al.	D14/258
D. 310,369	9/1990	Kolenda et al.	D14/258
D. 313,023	12/1990	Kolenda et al.	D14/258
D. 314,966	2/1991	Magic et al.	D14/258
D. 345,737	5/1994	Muccioli et al.	D14/258

[73] Assignee: **Chrysler Corporation, Highland Park, Mich.**

Primary Examiner—Theodore M. Shooman
Attorney, Agent, or Firm—Edward A. Craig

[**] Term: **14 Years**

[57] CLAIM

The ornamental design for a front panel for a combined radio and cassette tape player, as shown and described.

[21] Appl. No.: **9,668**

DESCRIPTION

[22] Filed: **Jun. 21, 1993**

FIG. 1 is a view in perspective of a combined radio and cassette tape player showing out new design;
FIG. 2 is a front elevational view thereof;
FIG. 3 is a top plan view thereof;
FIG. 4 is a bottom plan view thereof;
FIG. 5 is a left side elevational view thereof; and,
FIG. 6 is a right side elevational view thereof.

[52] U.S. Cl. **D14/258; D14/157**

[58] Field of Search **D14/124, 137, 157, 217, D14/257, 258, 299; 455/73, 89-90, 128, 345-347**

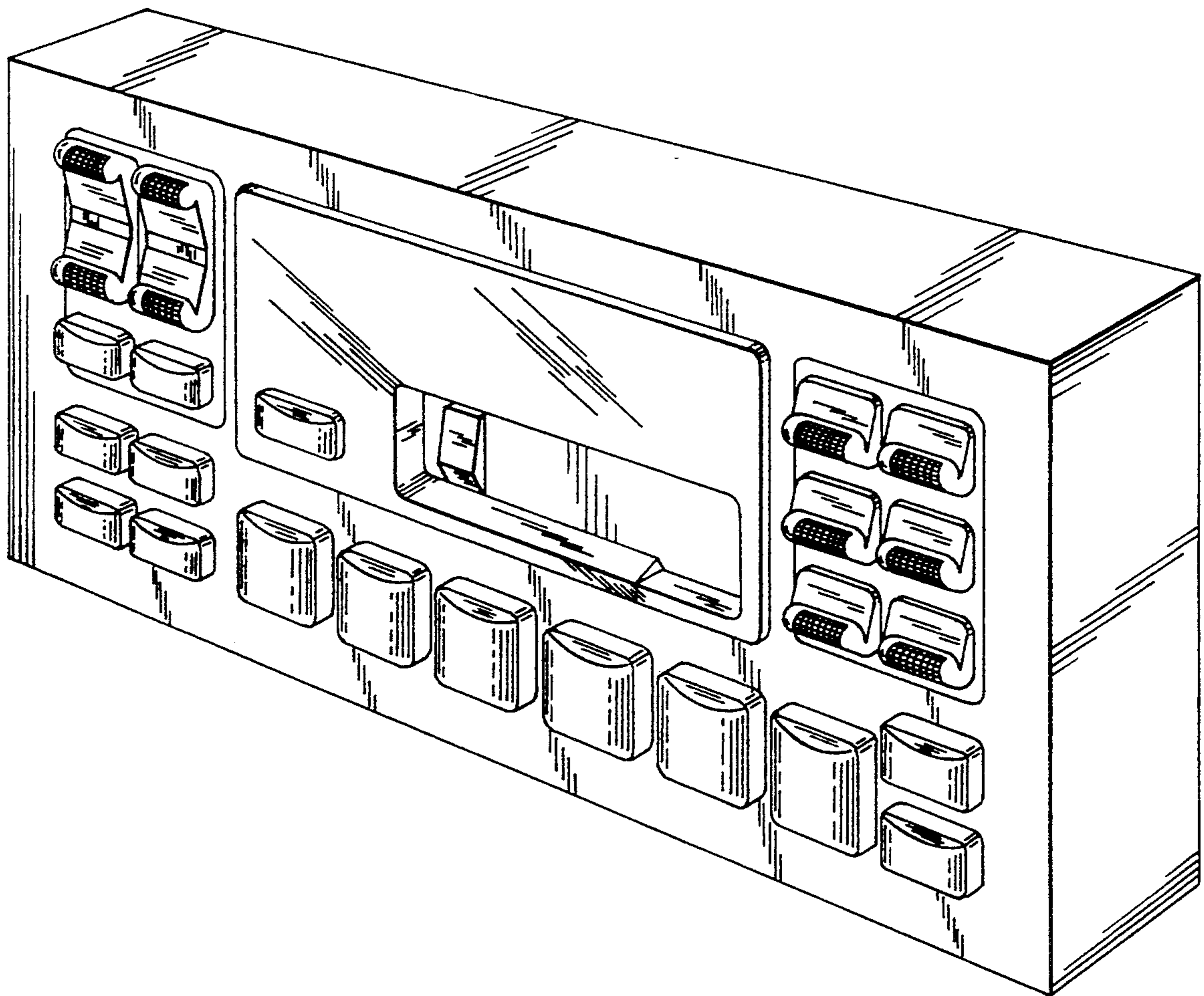

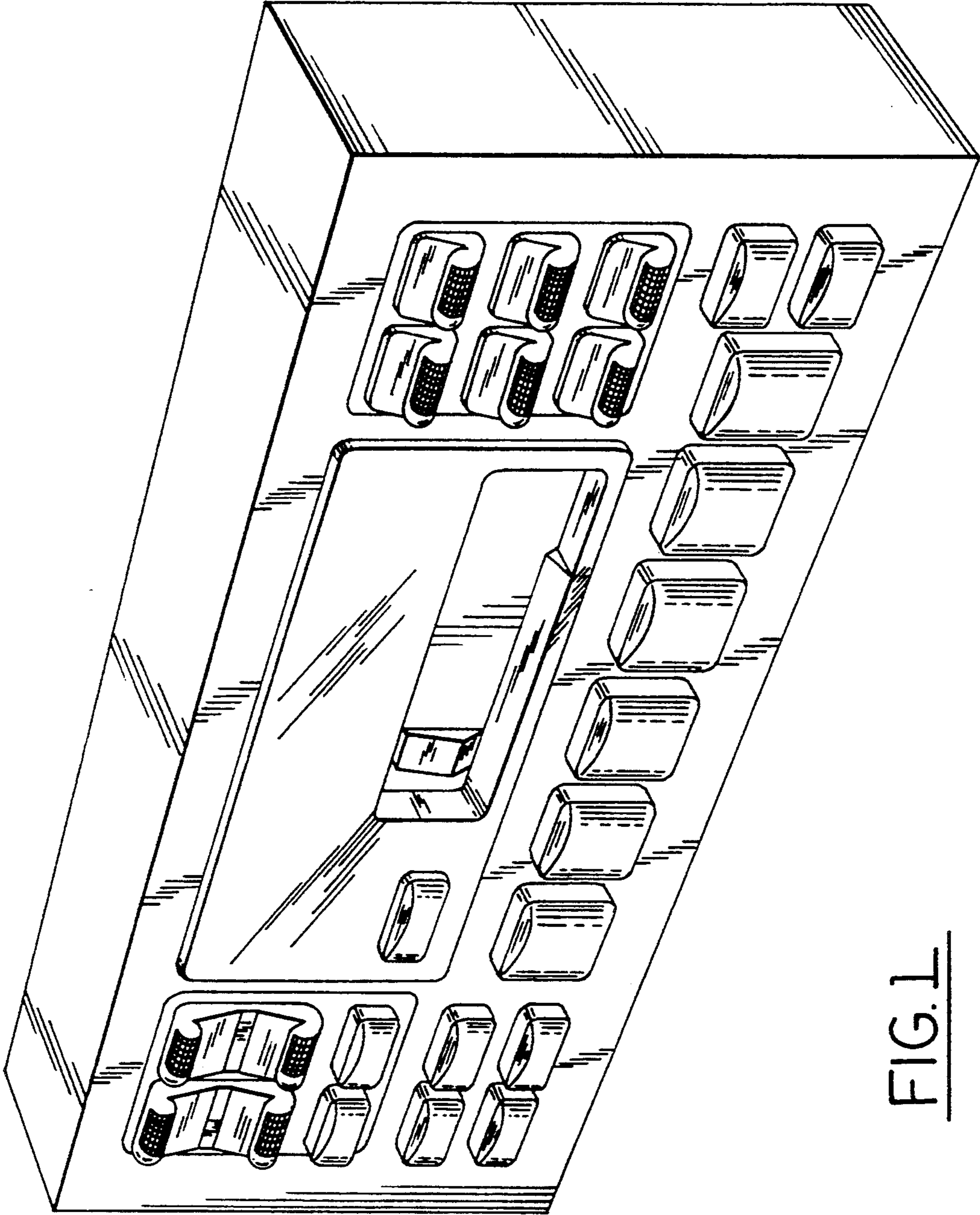

FIG. 1

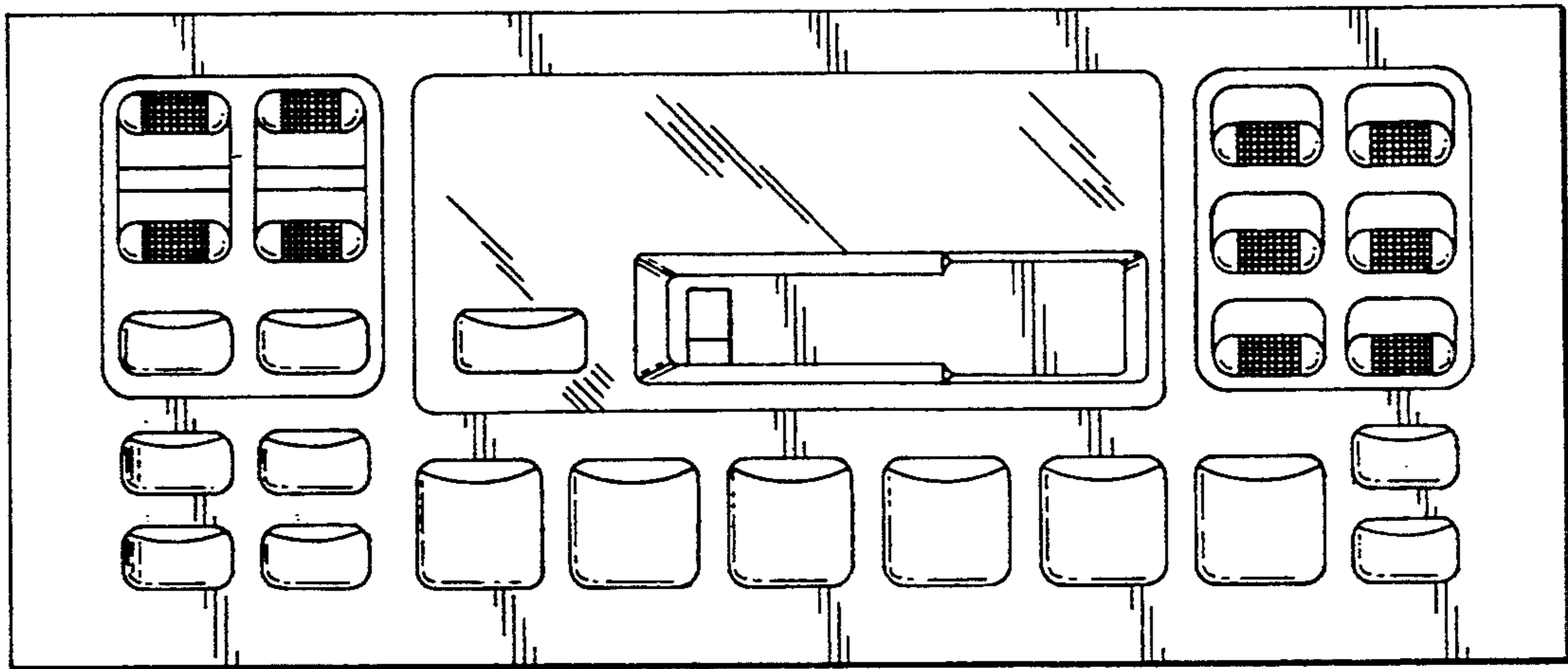

FIG. 2

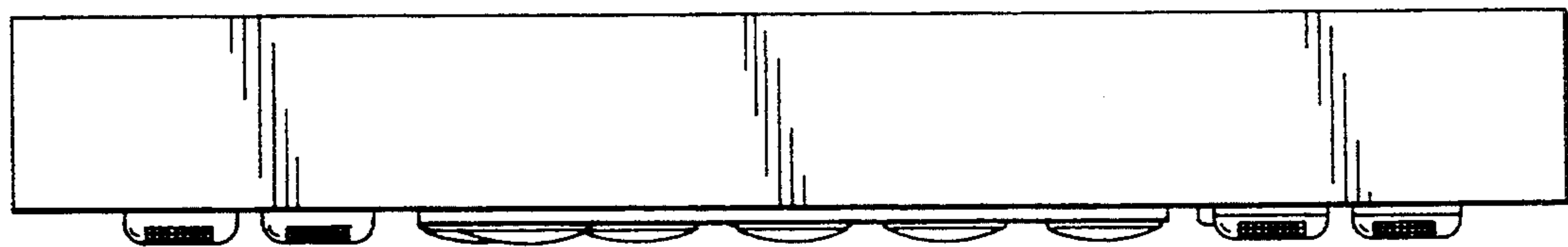

FIG. 3

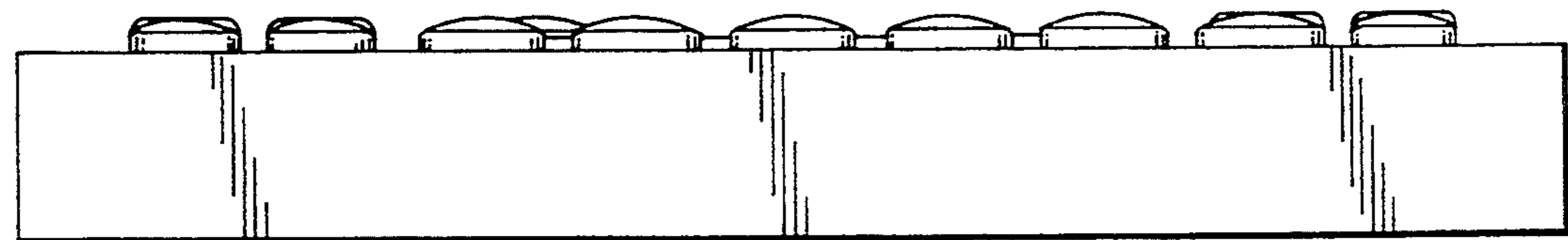

FIG. 4

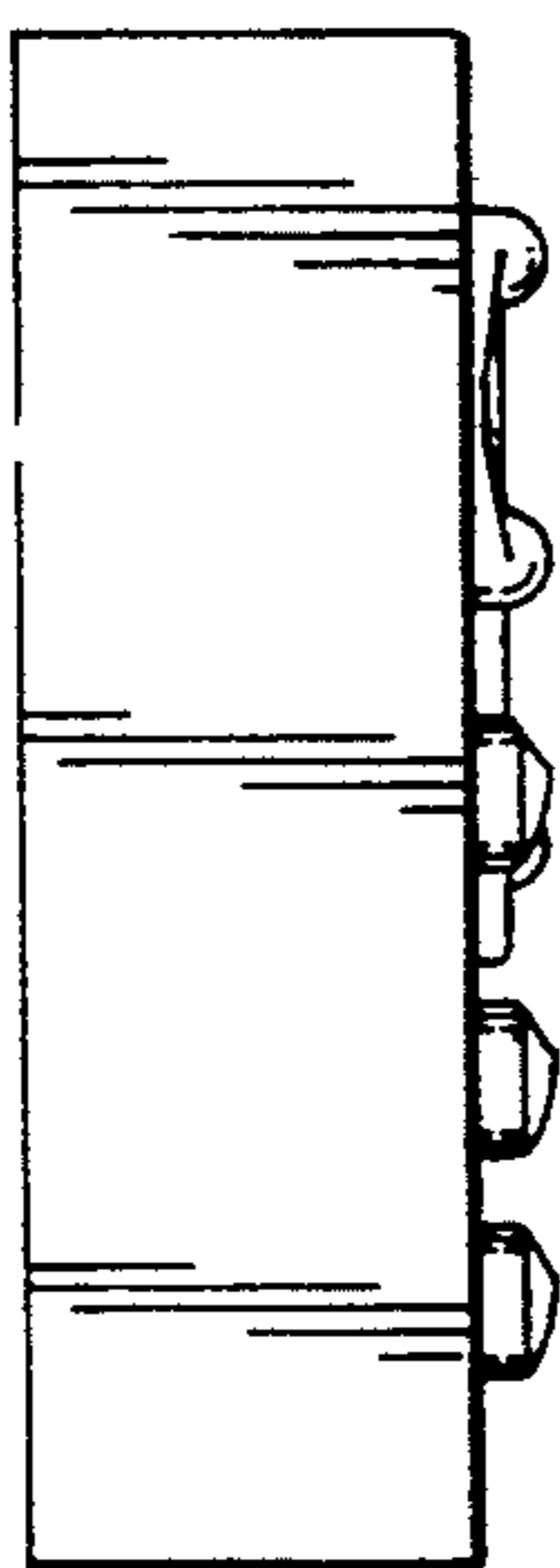

FIG. 5

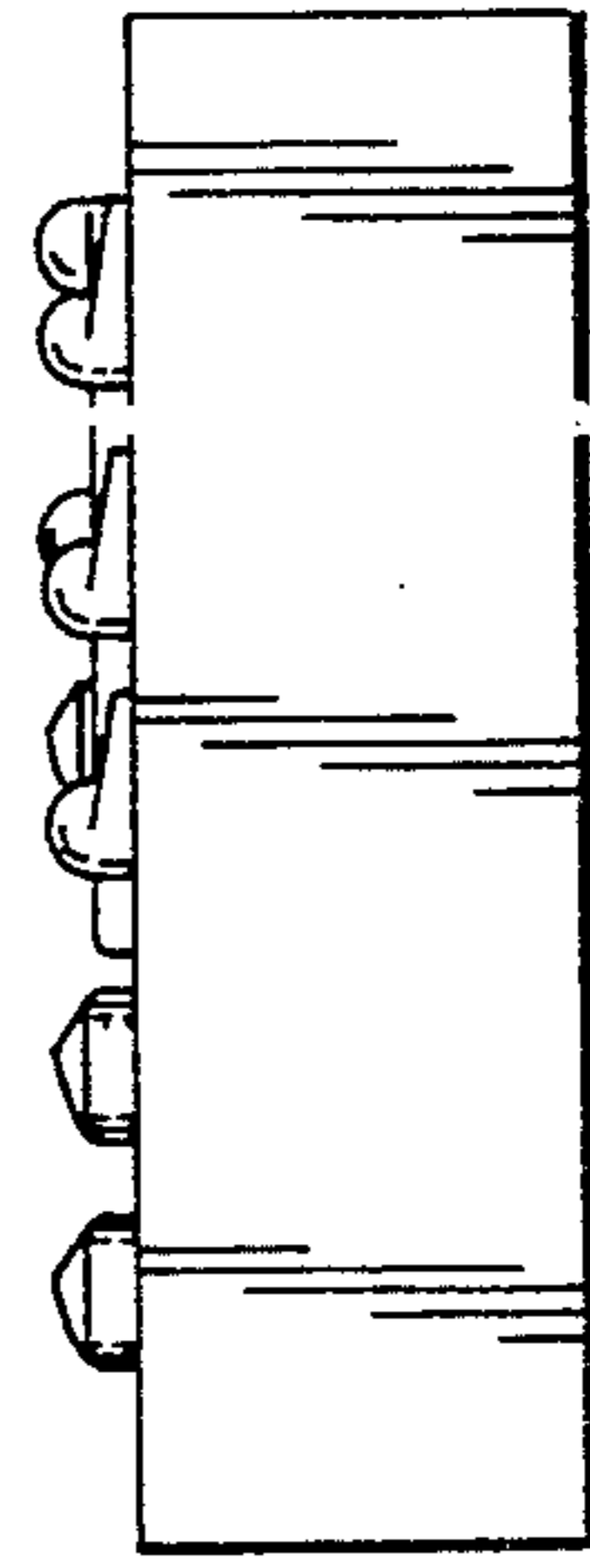

FIG. 6