



US00D355965S

United States patent [19]

Harrison et al.

[11] Patent Number: **Des. 355,965**

[45] Date of Patent: **** Feb. 28, 1995**

[54] **PACIFIER**

[75] Inventors: **Susan Harrison**, Wichita Falls, Tex.;
David W. Crossley, Woonsocket,
R.I.; **Michael S. Bernstein**, Natick;
Michael I. Lerner, Brookline, both of
Mass.

[73] Assignee: **Safety 1st, Inc.**, Chestnut Hill, Mass.

[**] Term: **14 Years**

[21] Appl. No.: **696,524**

[22] Filed: **May 7, 1991**

Related U.S. Application Data

[63] Continuation-in-part of ser. No. 631,031, Dec. 20,
1990, abandoned.

[52] U.S. Cl. **D24/195; D24/194**

[58] Field of Search **D24/193-199;**
D1/106-110; 606/234-236; 215/11.1-11.6;
446/419

[56] **References Cited**

U.S. PATENT DOCUMENTS

D. 269,461	6/1983	Qually	D24/195
D. 273,991	5/1984	Moore	D24/194
D. 287,767	1/1987	Simmons	D24/198
D. 296,471	6/1988	Marriott	D24/195
D. 309,017	7/1990	Lindberg	D24/196
D. 312,312	11/1990	Herritz	D24/194
4,454,204	6/1984	Posey	446/419

Primary Examiner—Stella Reid

Attorney, Agent, or Firm—Wolf, Greenfield & Sacks

[57] **CLAIM**

The ornamental design for a pacifier, as shown.

DESCRIPTION

FIG. 1 is a perspective view of a pacifier showing our new design;

FIG. 2 is a front view thereof;

FIG. 3 is a rear view thereof;

FIG. 4 is a left side view thereof;

FIG. 5 is a right side view thereof;

FIG. 6 is a top view thereof; and,

FIG. 7 is a bottom view thereof.

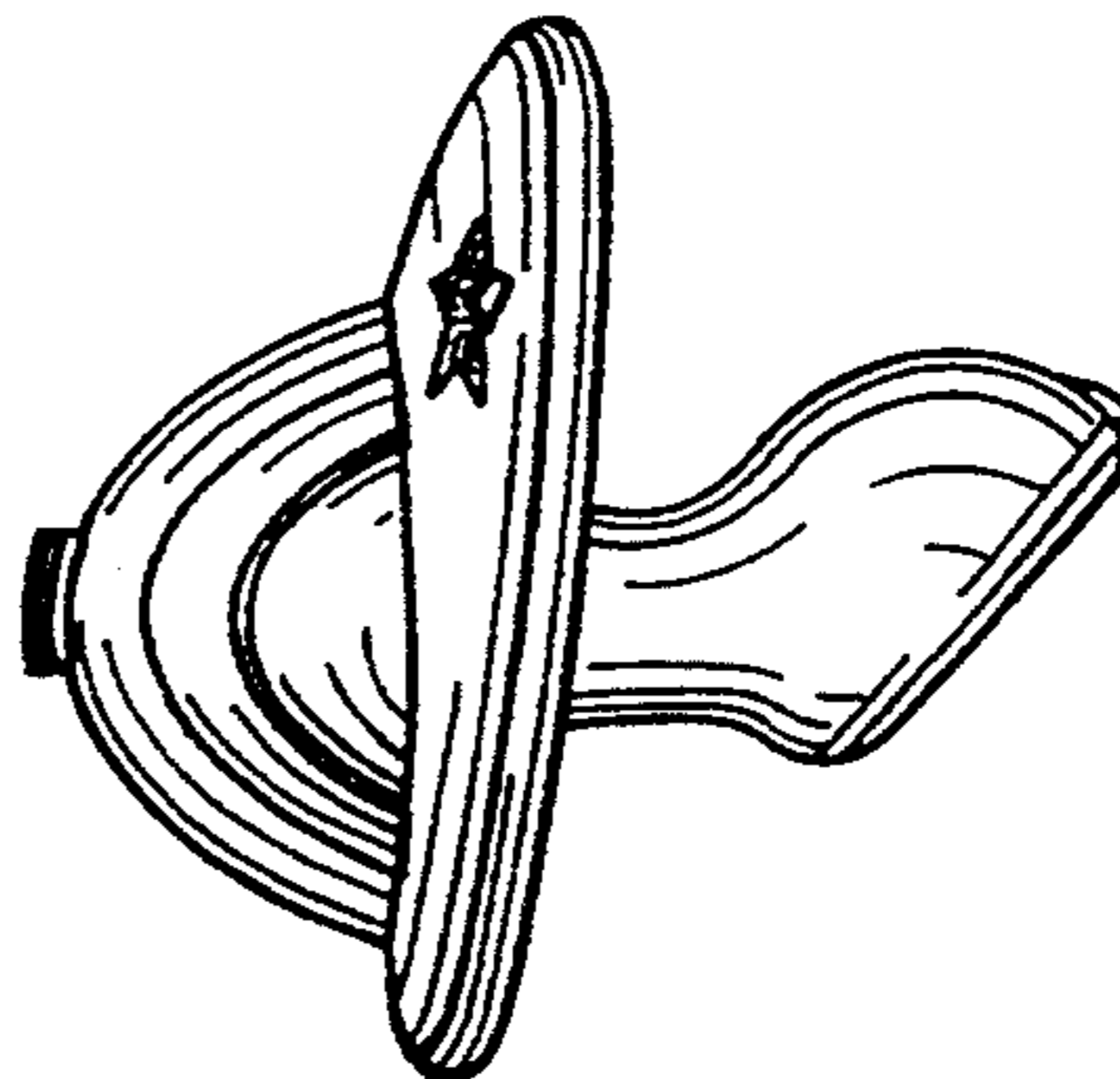
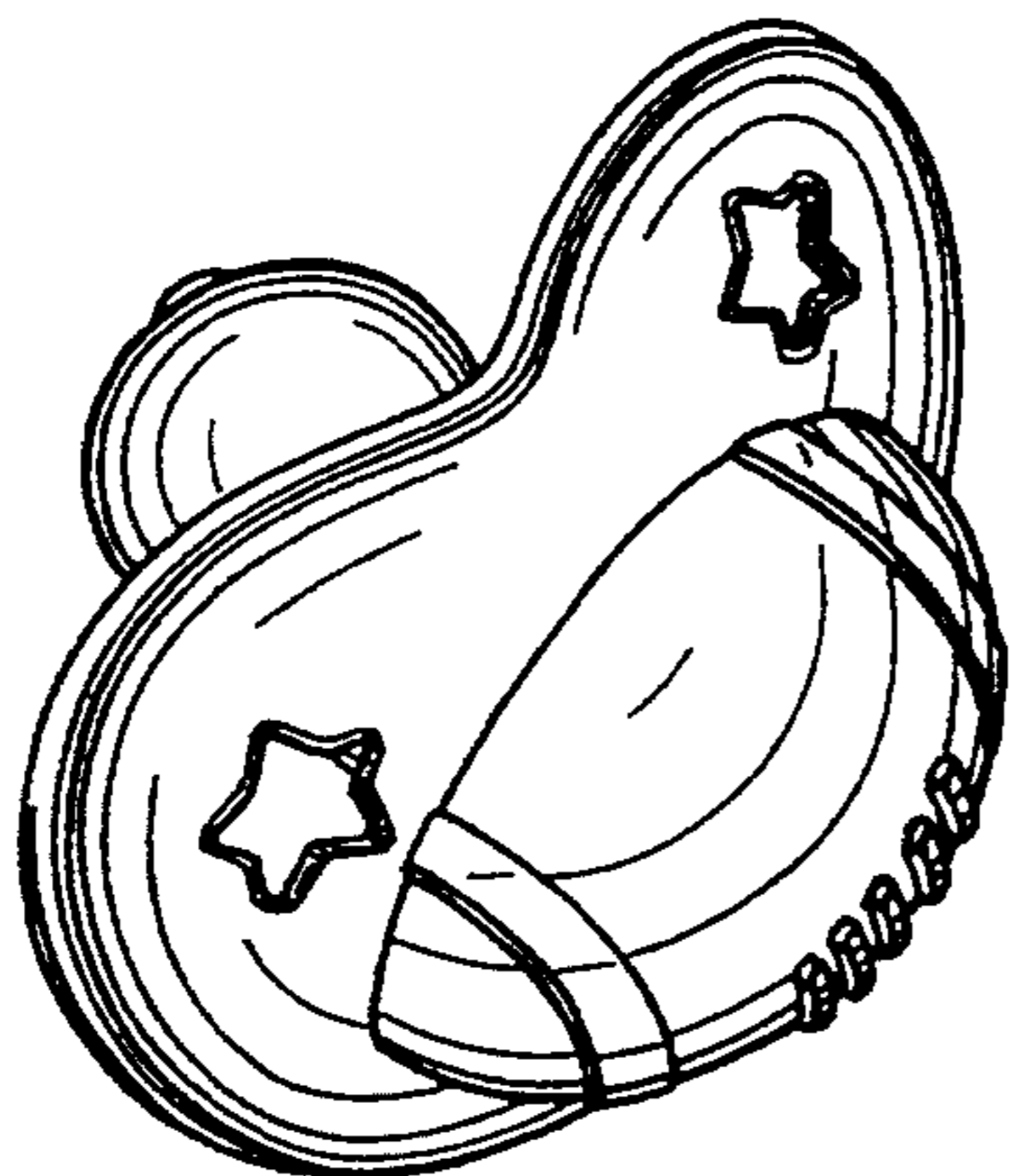

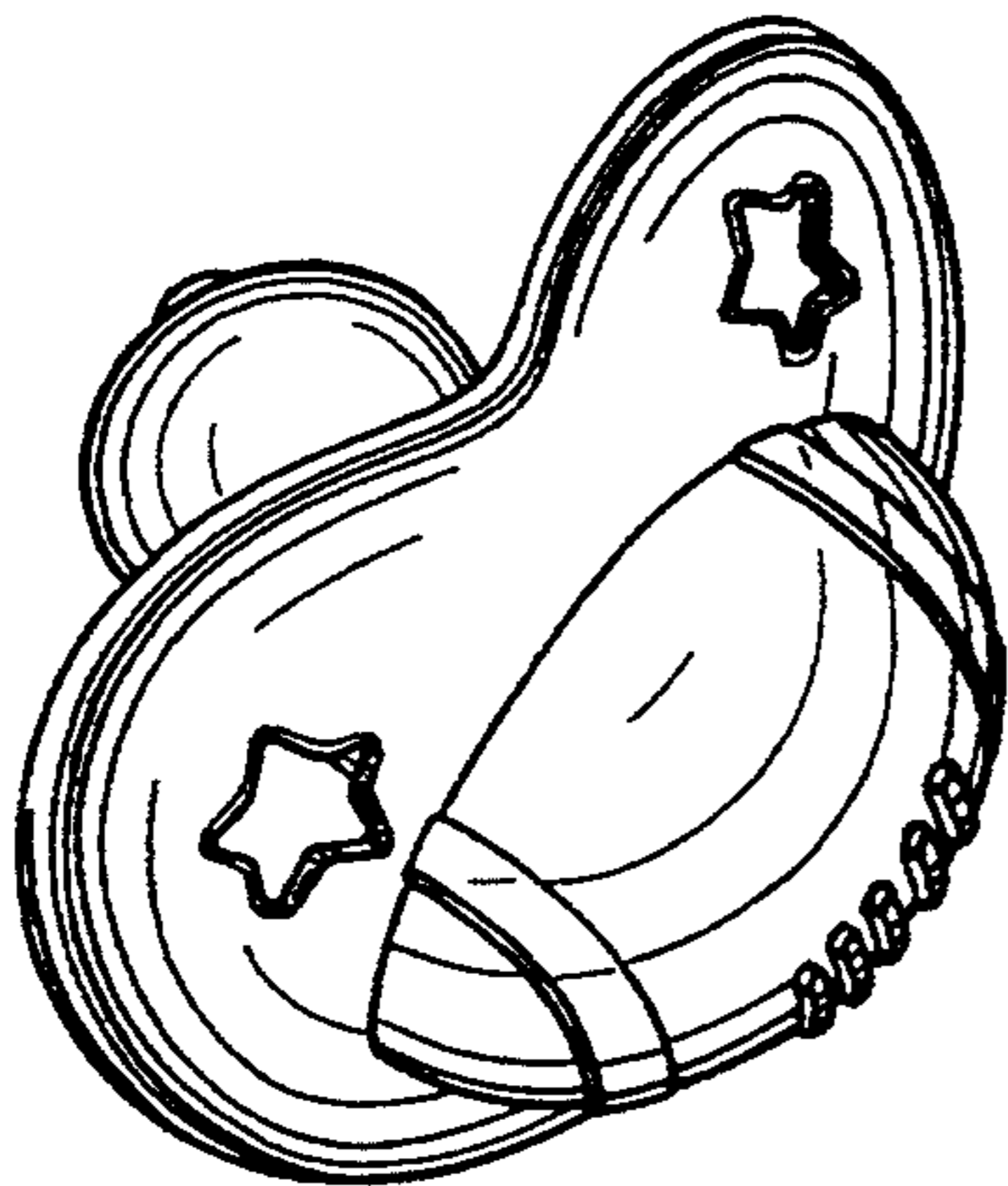

Fig. 1

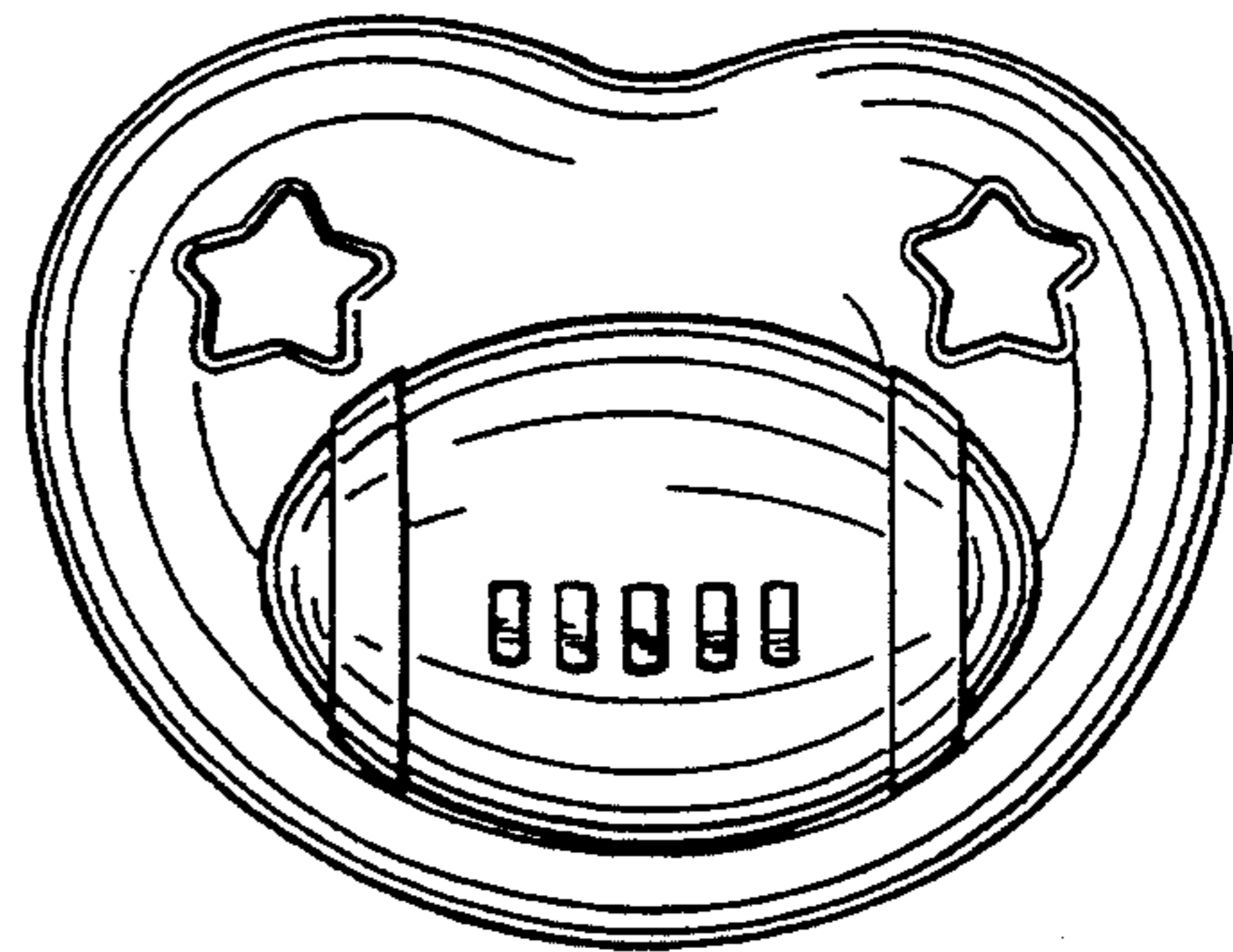

Fig. 2

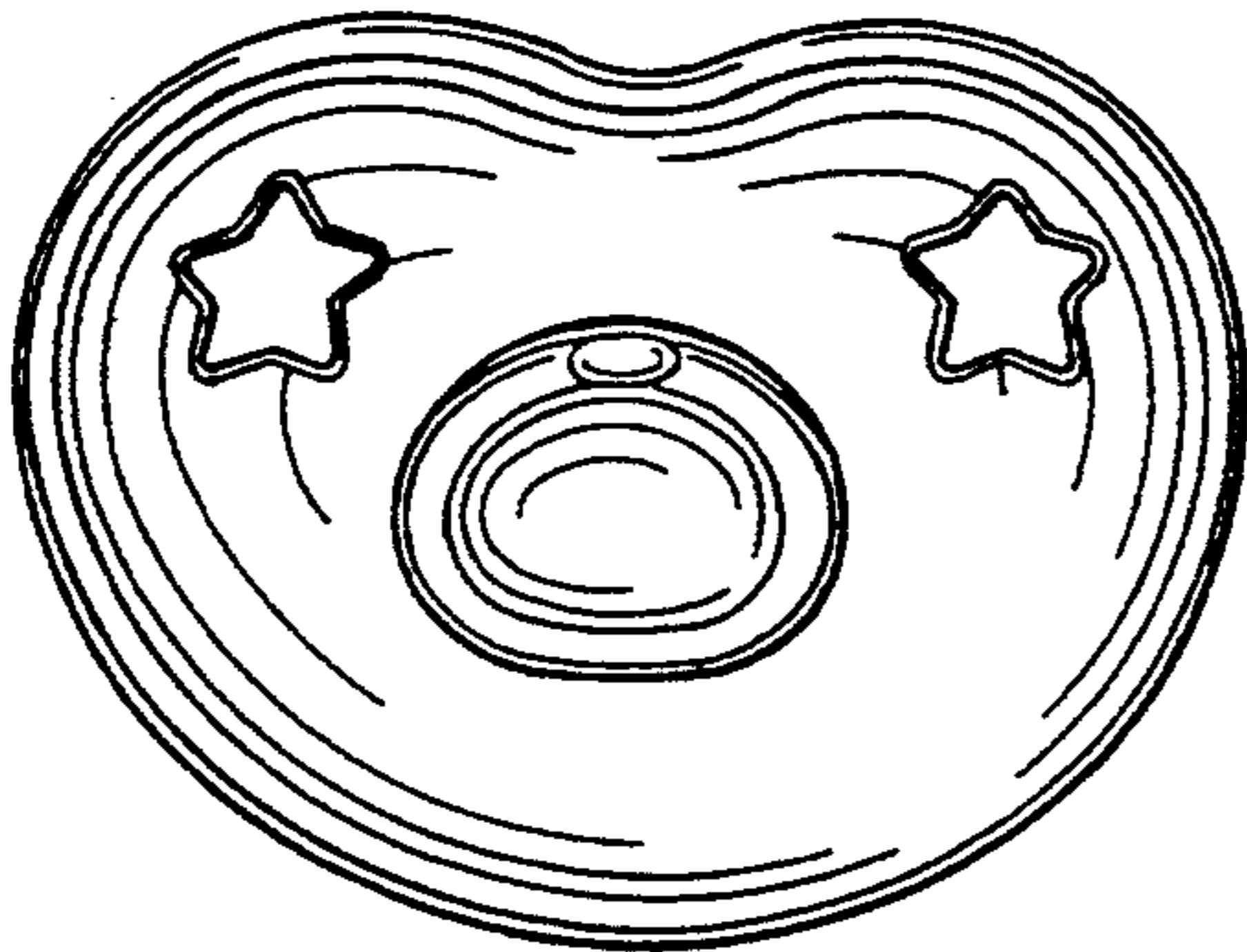

Fig. 3

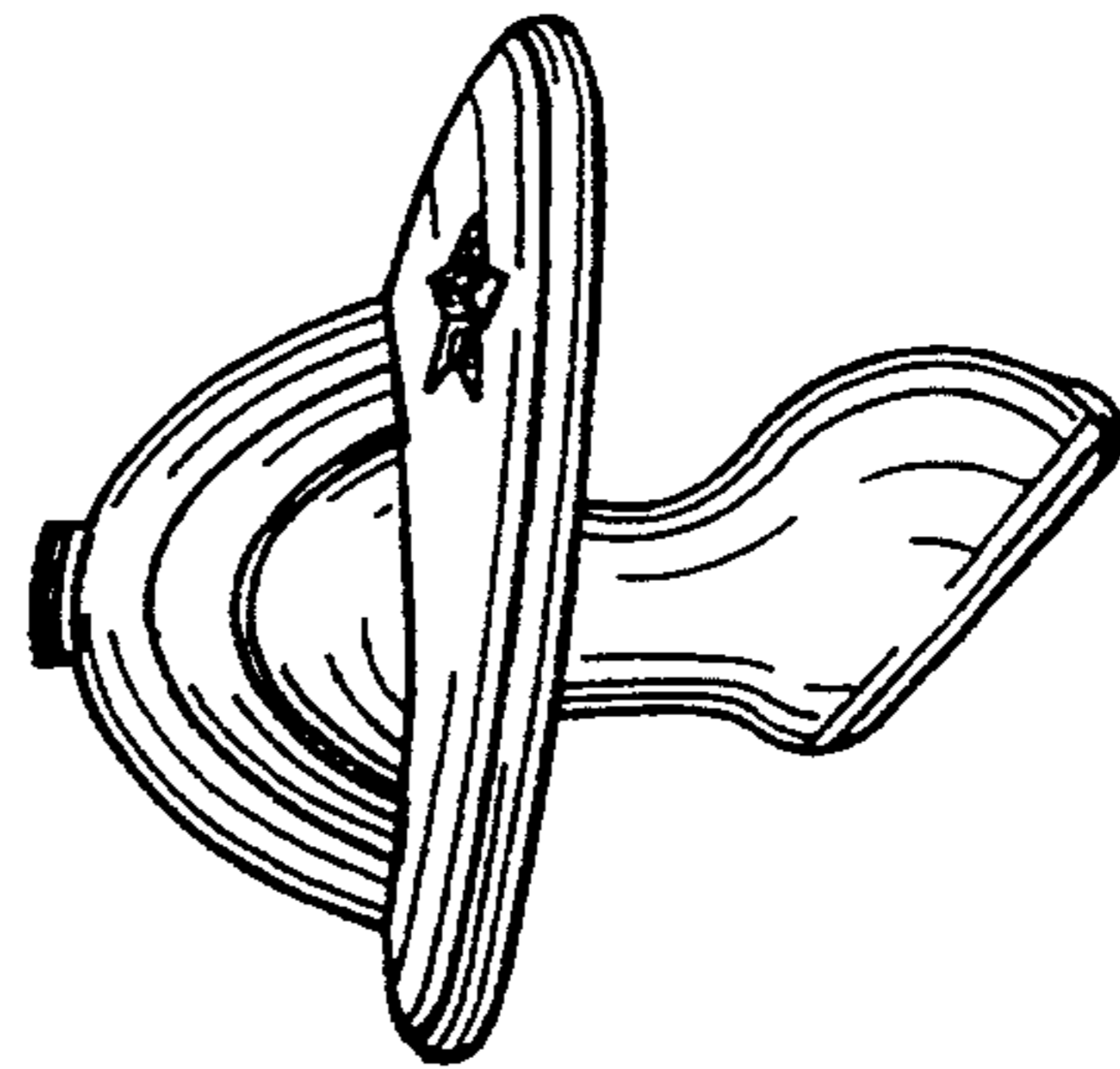

Fig. 4

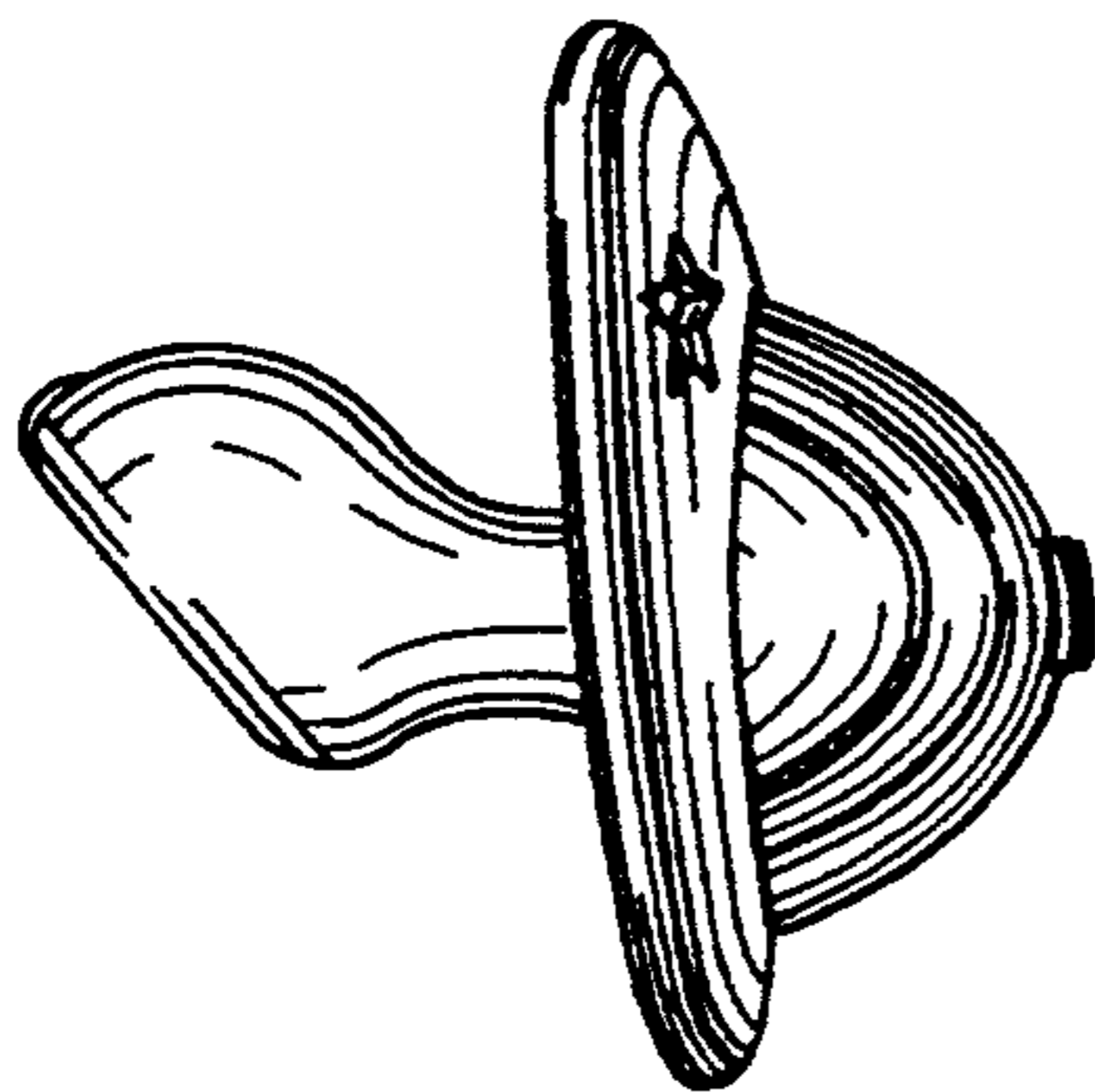

Fig. 5

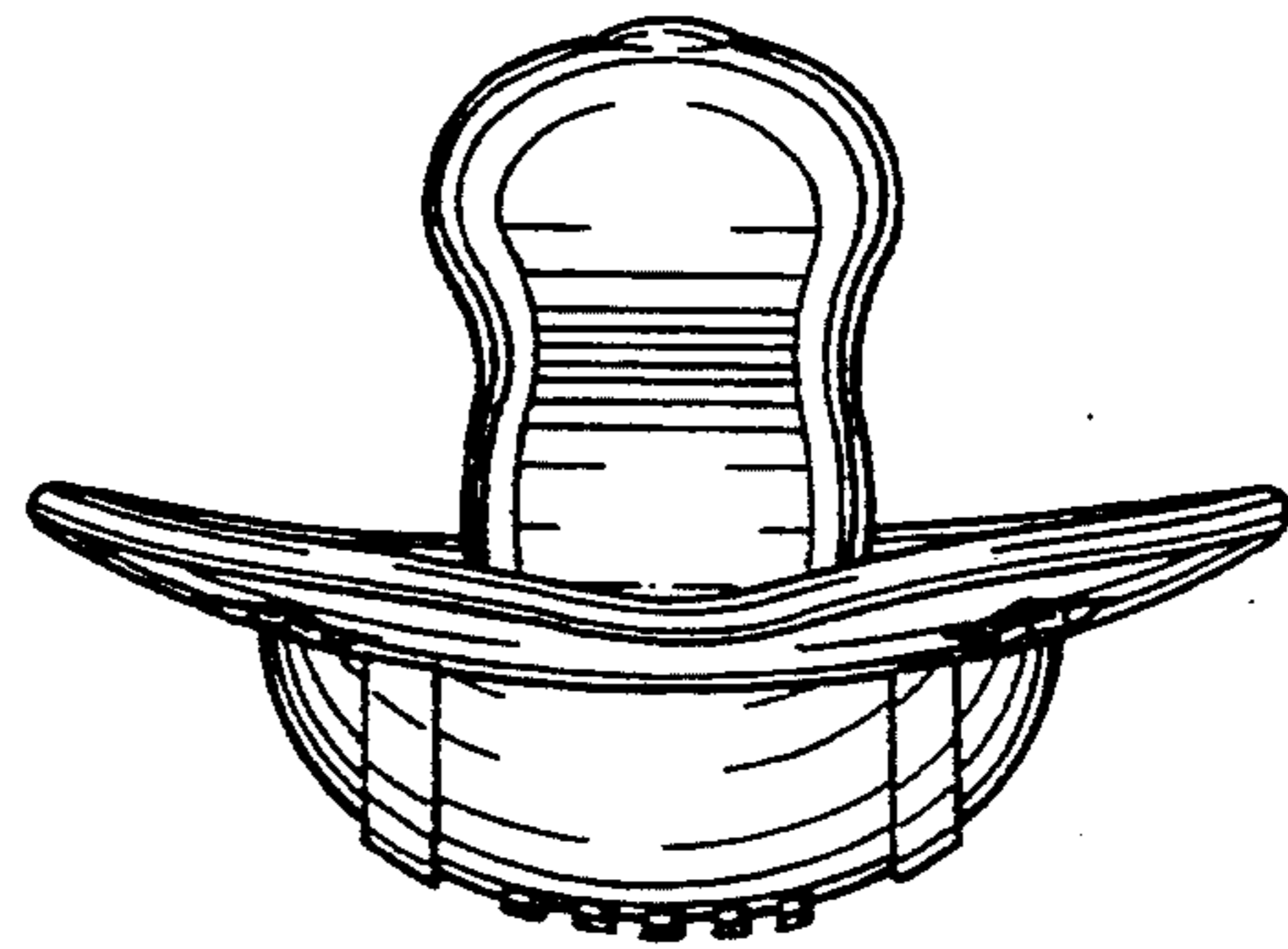

Fig. 6

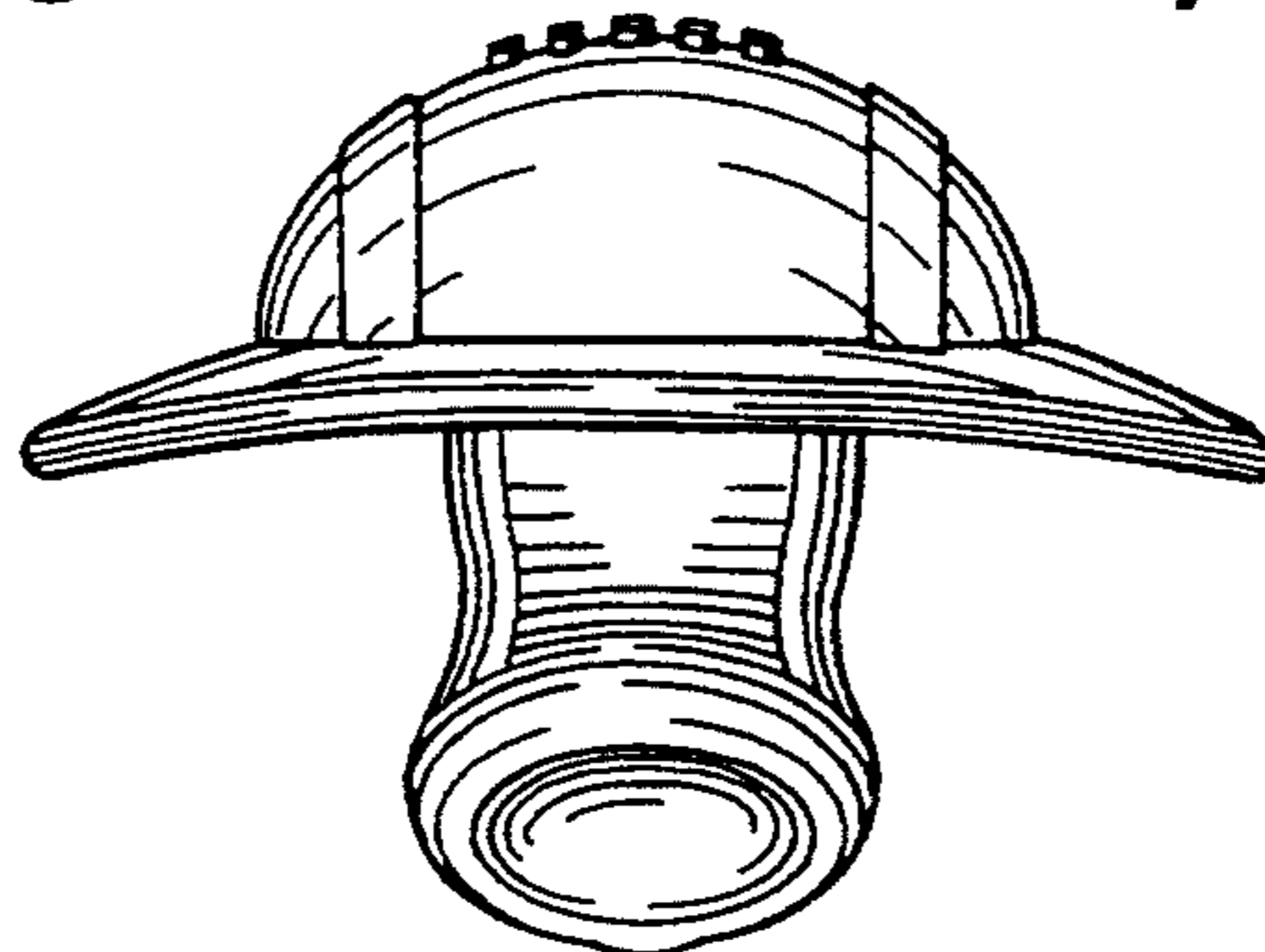

Fig. 7