



US00D355949S

United States Patent [19]

[11] Patent Number: **Des. 355,949**

Laughton

[45] Date of Patent: **** Feb. 28, 1995**

[54] **DESIGN FOR SINK**
 [75] Inventor: **John Laughton**, Polegate, England
 [73] Assignee: **American Standard Inc.**, Piscataway, N.J.
 [**] Term: **14 Years**
 [21] Appl. No.: **13,057**
 [22] Filed: **Sep. 16, 1993**

2,583,922 1/1952 Zummach .
 2,767,407 10/1956 Weiss .
 2,841,799 7/1958 Traynor .
 4,193,141 3/1980 Rosenberg et al. .
 4,295,233 10/1981 Hinkel et al. .
 4,462,126 7/1984 Cleaveland .
 4,991,241 2/1991 Bergmann et al. 4/619

OTHER PUBLICATIONS

Ingersoll-Humphryes Division, Borg-Warner Corp. Brochure, p. 2, "Carroll" & Earthem Lavatories.

Primary Examiner—James R. Largen
Attorney, Agent, or Firm—Elaine Brenner Robinson; Ann M. Knab

[30] **Foreign Application Priority Data**
 Jun. 25, 1993 [GB] United Kingdom 2032006
 Jun. 25, 1993 [GB] United Kingdom 2032007
 Jun. 25, 1993 [GB] United Kingdom 2032008
 [52] U.S. Cl. **D23/284**
 [58] Field of Search D23/284-293.1;
 4/619, 631-636

[57] **CLAIM**
 The ornamental design for a sink, as shown and described.

[56] **References Cited**
U.S. PATENT DOCUMENTS
 D. 45,284 2/1914 Alpaugh D23/287
 D. 76,700 10/1928 Nash D23/293.1
 D. 95,378 4/1935 Morgan D23/293.1
 D. 172,707 7/1954 Ferrar D23/286
 D. 194,021 11/1962 Chapman D23/293.1
 D. 252,100 6/1979 Morris et al. D23/284
 D. 319,493 8/1991 Edmondson D23/284
 D. 321,753 11/1991 Bengtson et al. D23/284
 2,185,186 1/1940 Coordes 4/619
 2,210,933 8/1940 Graf 4/619

DESCRIPTION

FIG. 1 is a top, front and left side perspective view of a sink showing my new design;
 FIG. 2 is a top plan view thereof;
 FIG. 3 is a left side elevational view thereof;
 FIG. 4 is a front elevational view thereof;
 FIG. 5 is a rear elevational view thereof;
 FIG. 6 is a bottom plan view thereof;
 FIG. 7 is a sectional view thereof taken on line 7-7 of FIG. 2; and,
 FIG. 8 is a sectional view thereof taken on line 8-8 of FIG. 2.

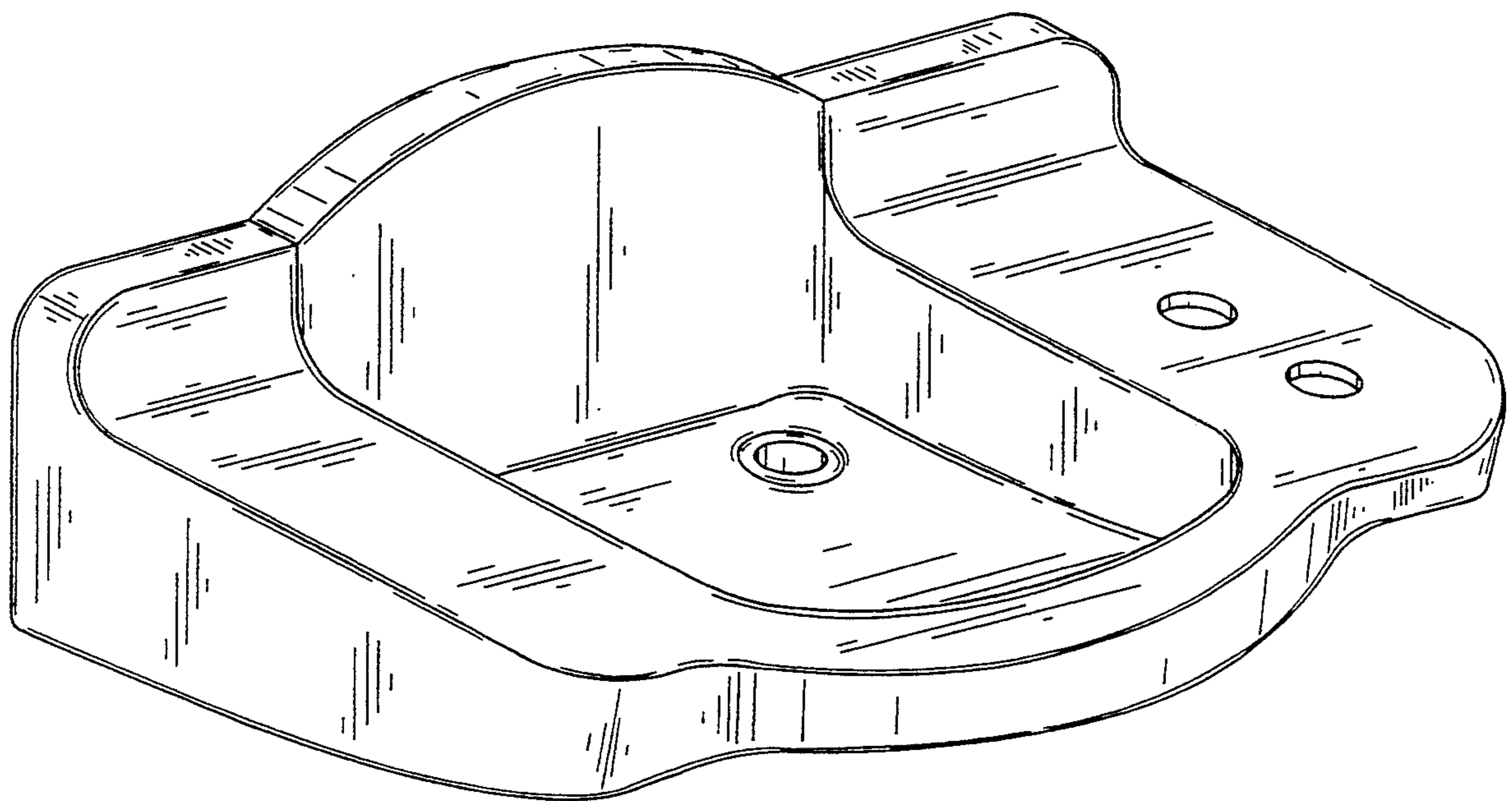

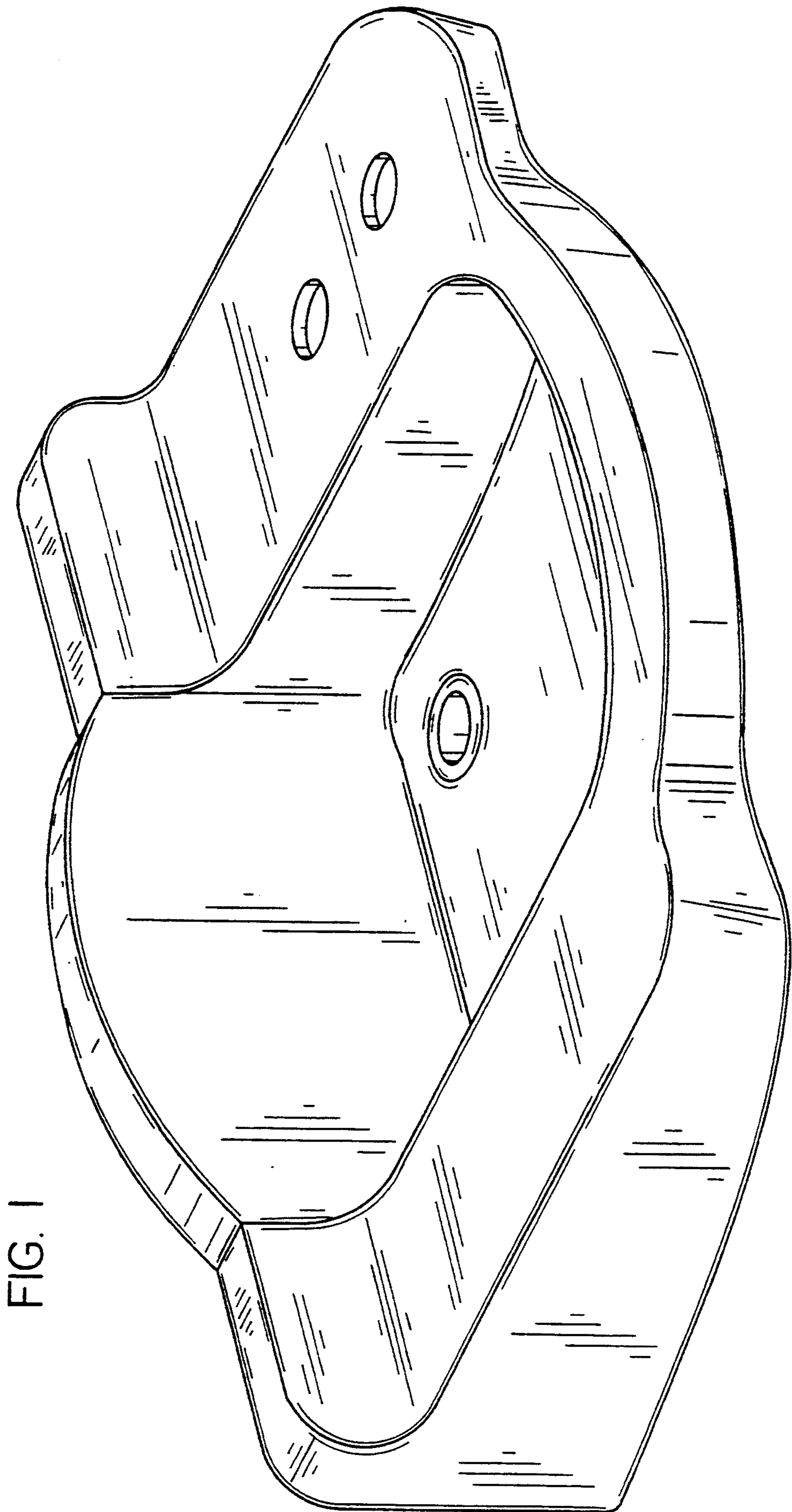

FIG. 1

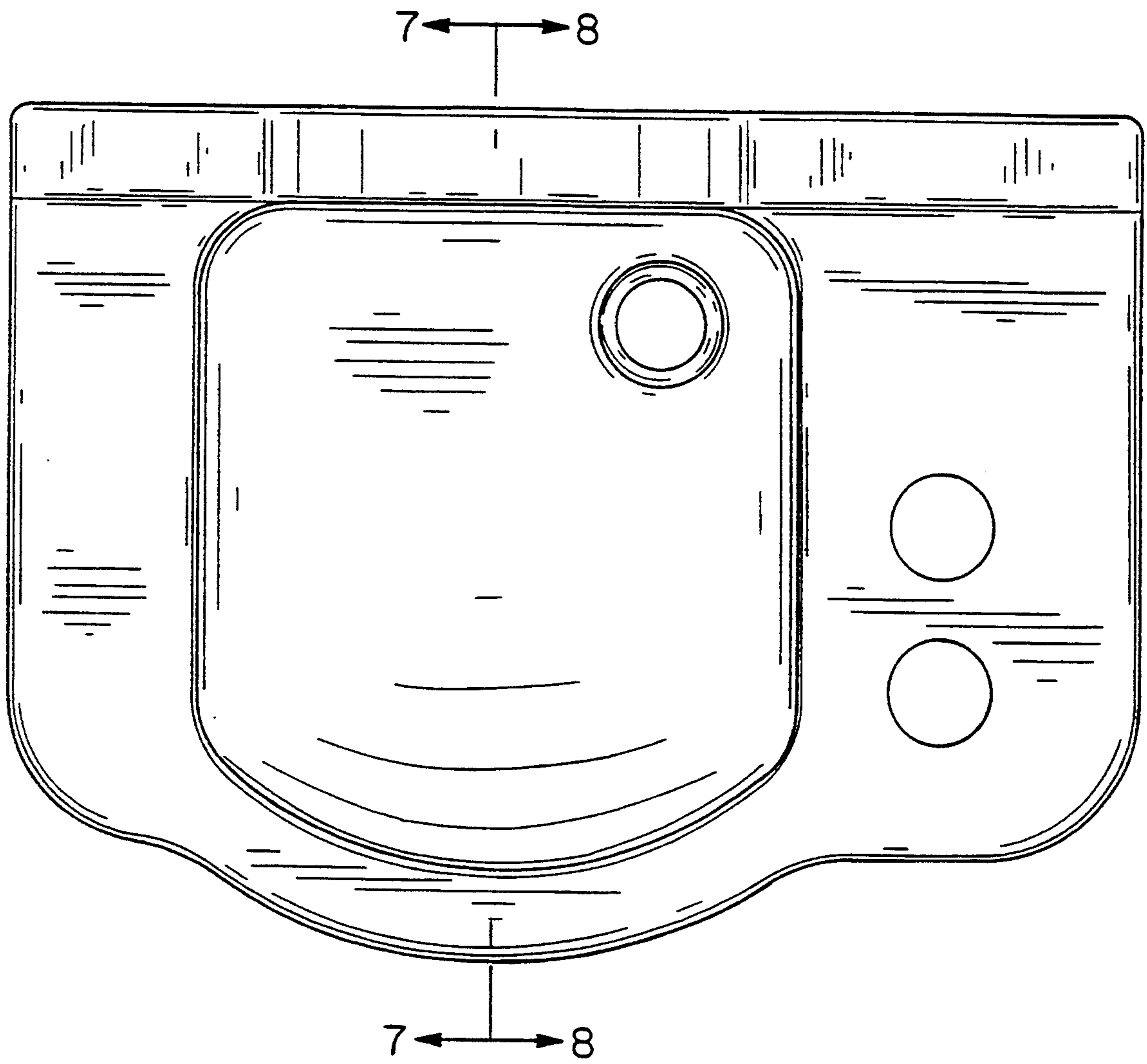

FIG. 2

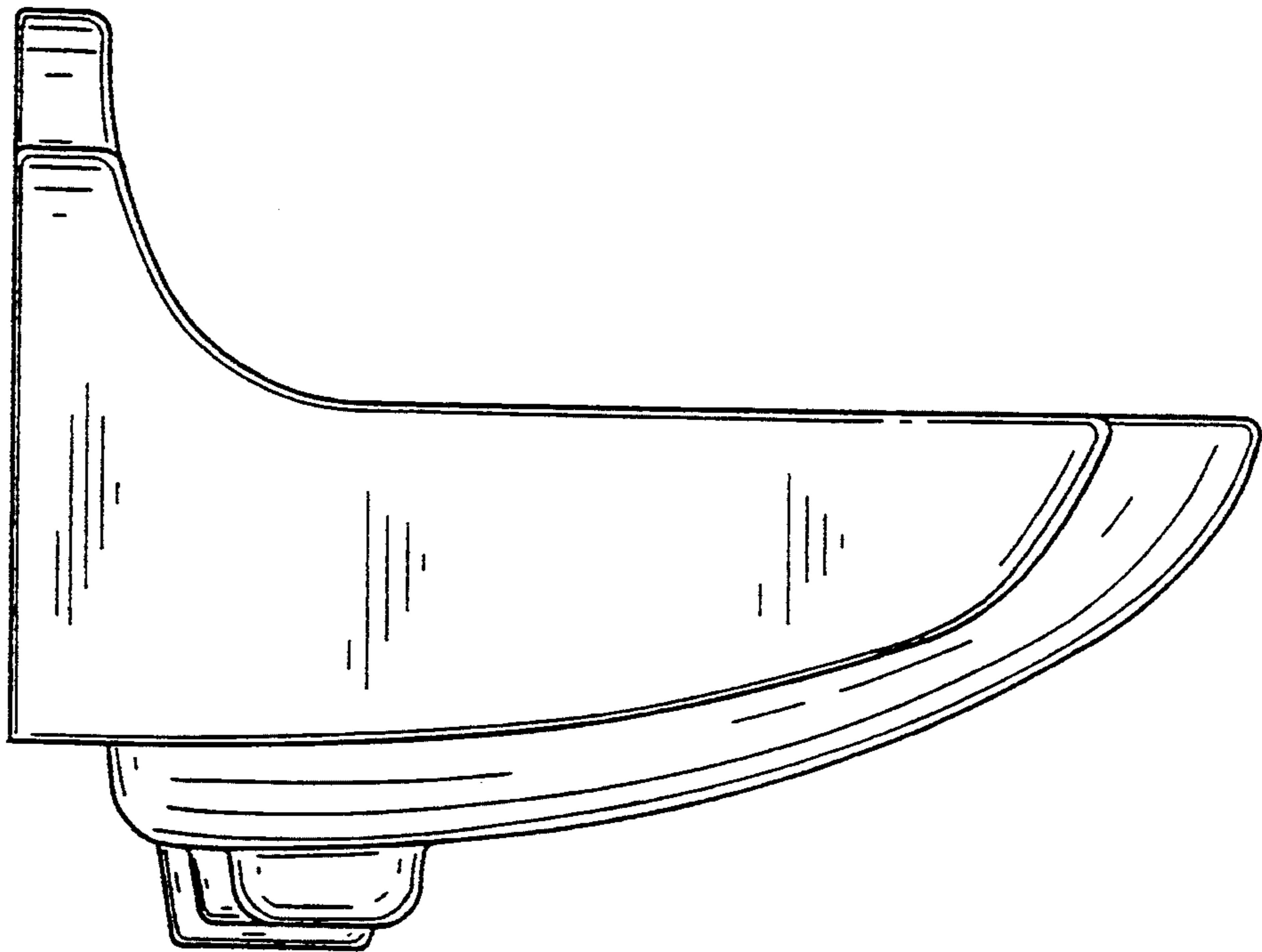

FIG. 3

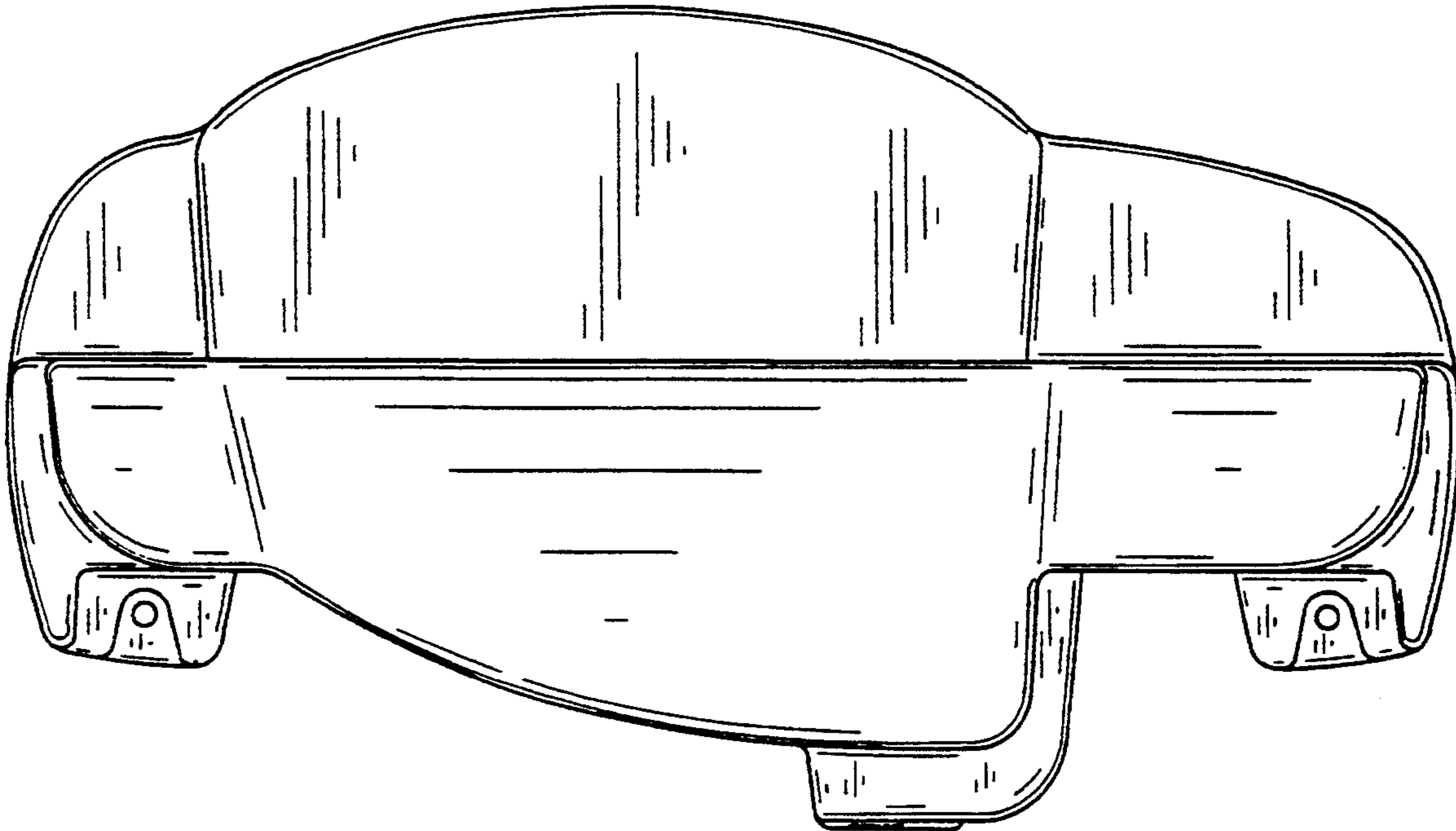

FIG. 4

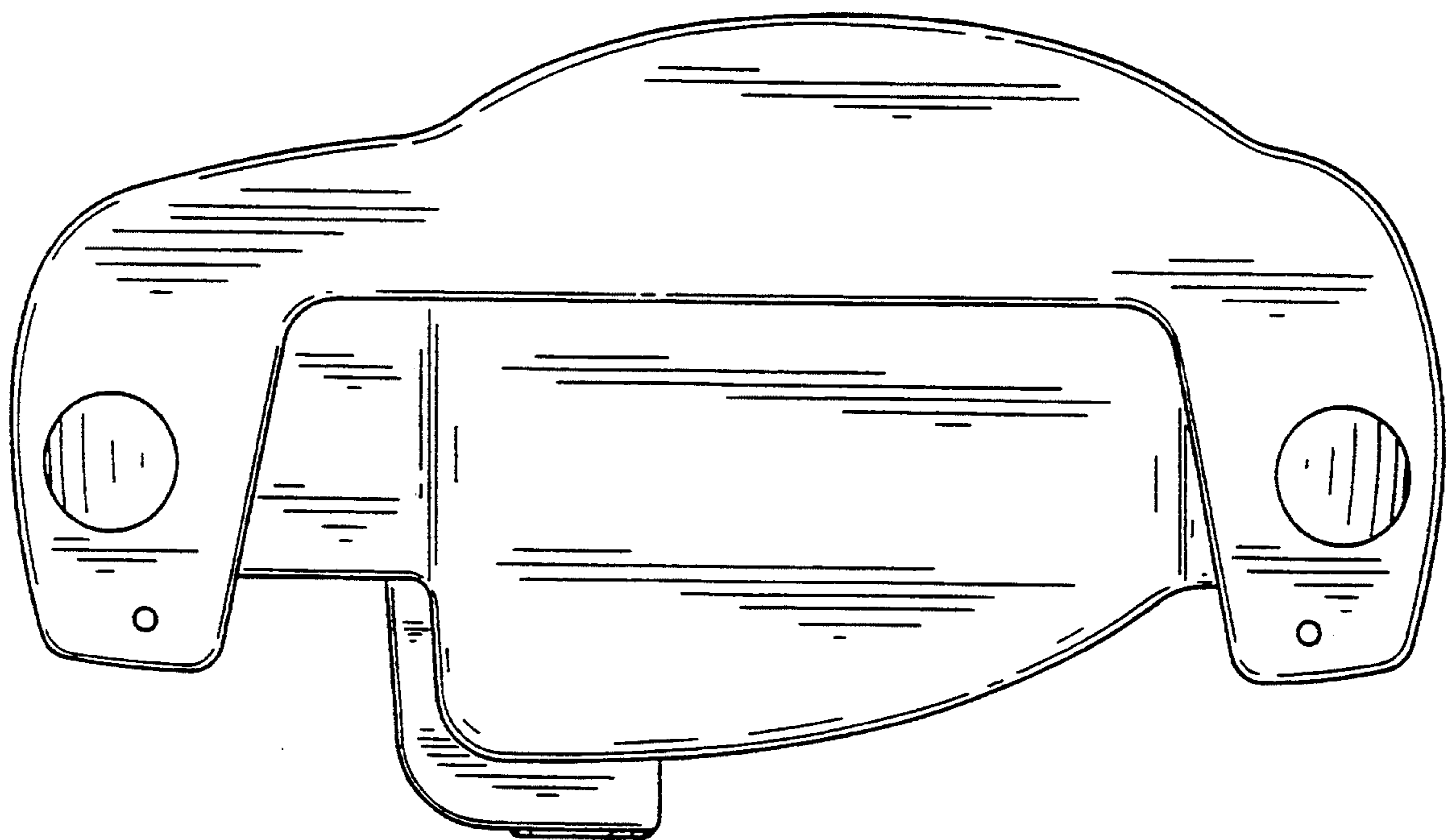

FIG. 5

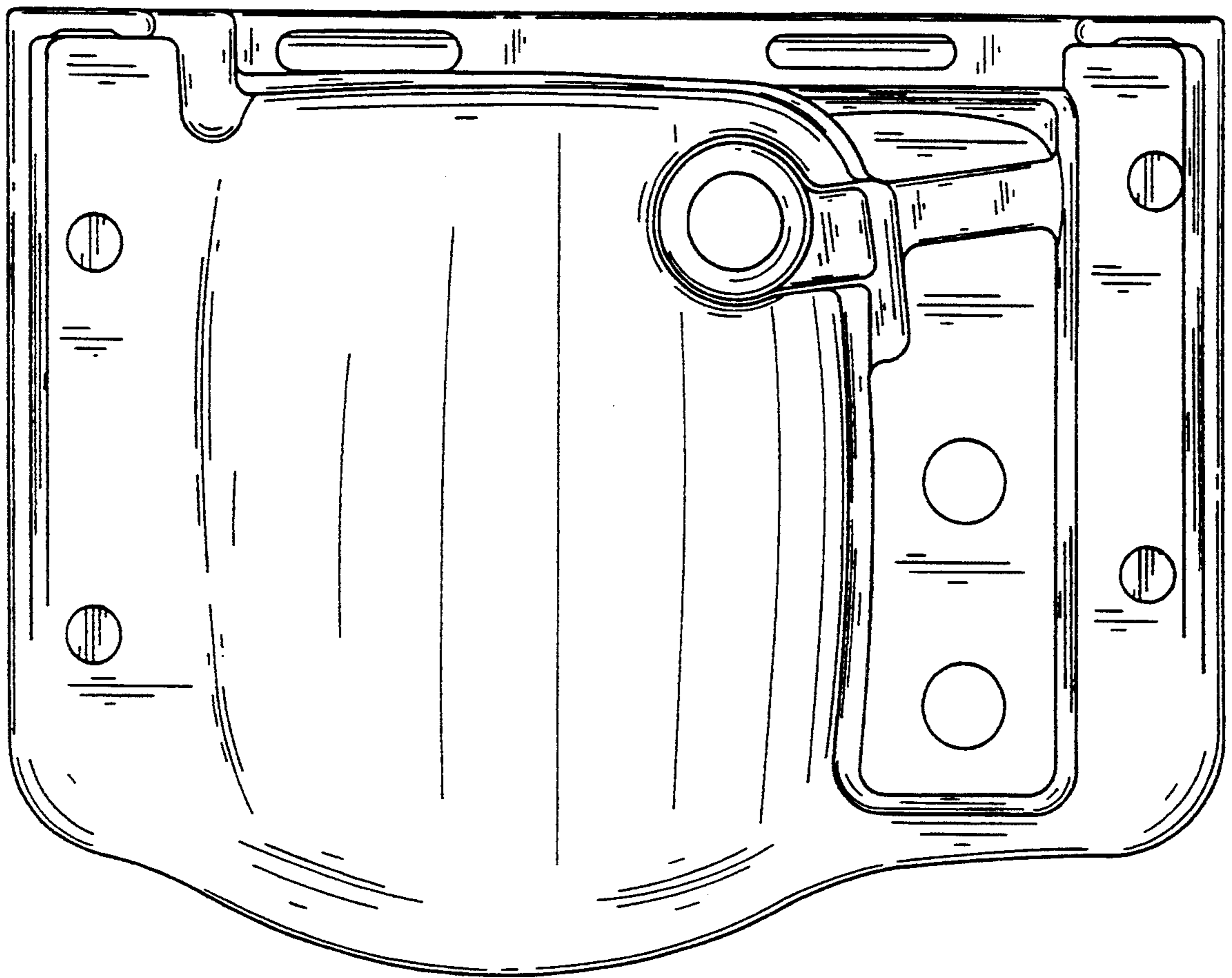

FIG. 6

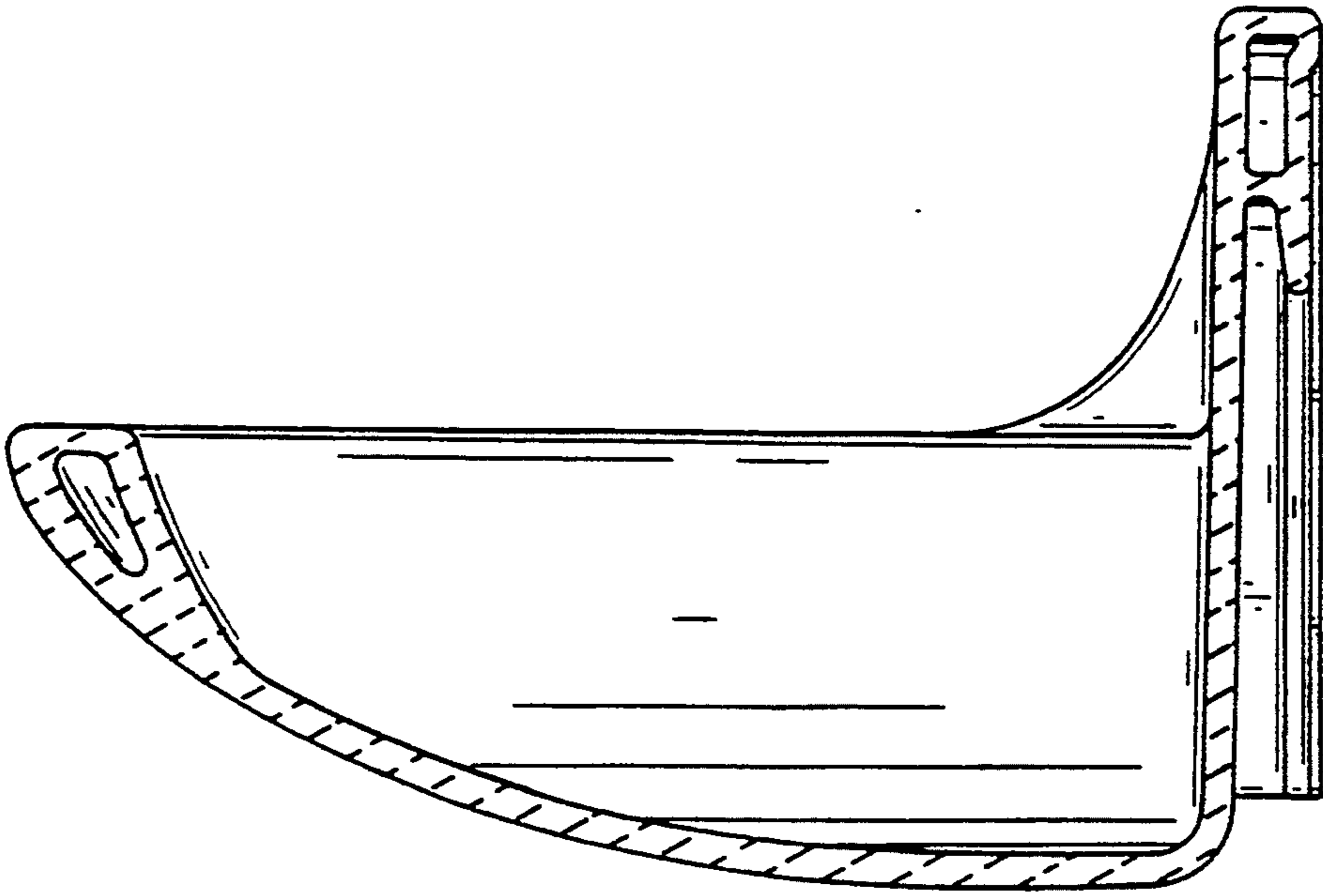

FIG. 7

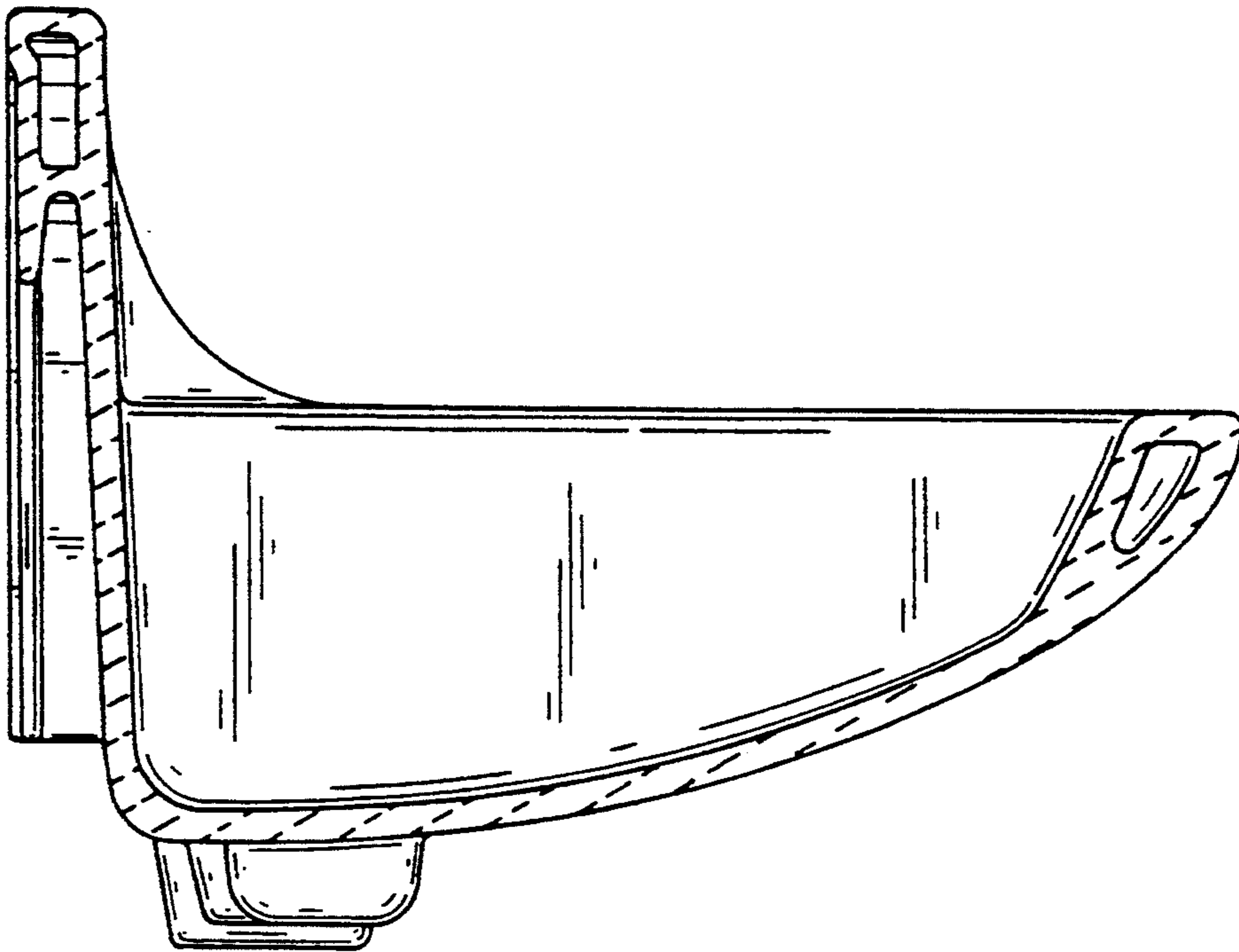

FIG. 8