



US00D355906S

United States Patent [19]

[11] Patent Number: **Des. 355,906**

Yoshihara et al.

[45] Date of Patent: **** Feb. 28, 1995**

[54] **FACSIMILE**

[75] Inventors: **Tsutomu Yoshihara, Ayase; Hideki Narushima**, Tokyo, both of Japan

[73] Assignee: **Canon Kabushiki Kaisha**, Tokyo, Japan

[**] Term: **14 Years**

[21] Appl. No.: **15,560**

[22] Filed: **Nov. 22, 1993**

[30] Foreign Application Priority Data

May 24, 1993 [JB] Japan 5-15061

[52] U.S. Cl. **D14/118**

[58] Field of Search D14/118, 124, 299;
358/400, 401

[56] **References Cited**

U.S. PATENT DOCUMENTS

D. 304,723	11/1989	Yoshihara	D14/117
D. 310,215	8/1990	Tsukada et al.	D14/118
D. 311,914	11/1990	Yoshihara	D14/118
D. 315,151	3/1991	Tamano et al.	D14/118
D. 315,342	3/1991	Yoshihara	D14/118

D. 315,344	3/1991	Yoshihara	D14/118
D. 331,403	12/1992	Yoshihara	D14/118
D. 331,404	12/1992	Yoshihara	D14/118
D. 334,923	4/1993	Dodge et al.	D14/118
D. 344,503	2/1994	Nakajima et al.	D14/118
D. 344,939	3/1994	Kashiwarara et al.	D14/118

Primary Examiner—Theodore M. Shooman
Attorney, Agent, or Firm—Fitzpatrick, Cella, Harper & Scinto

[57] **CLAIM**

The ornamental design for a facsimile, as shown and described.

DESCRIPTION

FIG. 1 is a front elevational view of a facsimile showing our new design;
FIG. 2 is a rear elevational view thereof;
FIG. 3 is a top plan view thereof;
FIG. 4 is a bottom plan view thereof;
FIG. 5 is a left side elevational view thereof;
FIG. 6 is a right side elevational view thereof; and,
FIG. 7 is a perspective view thereof.

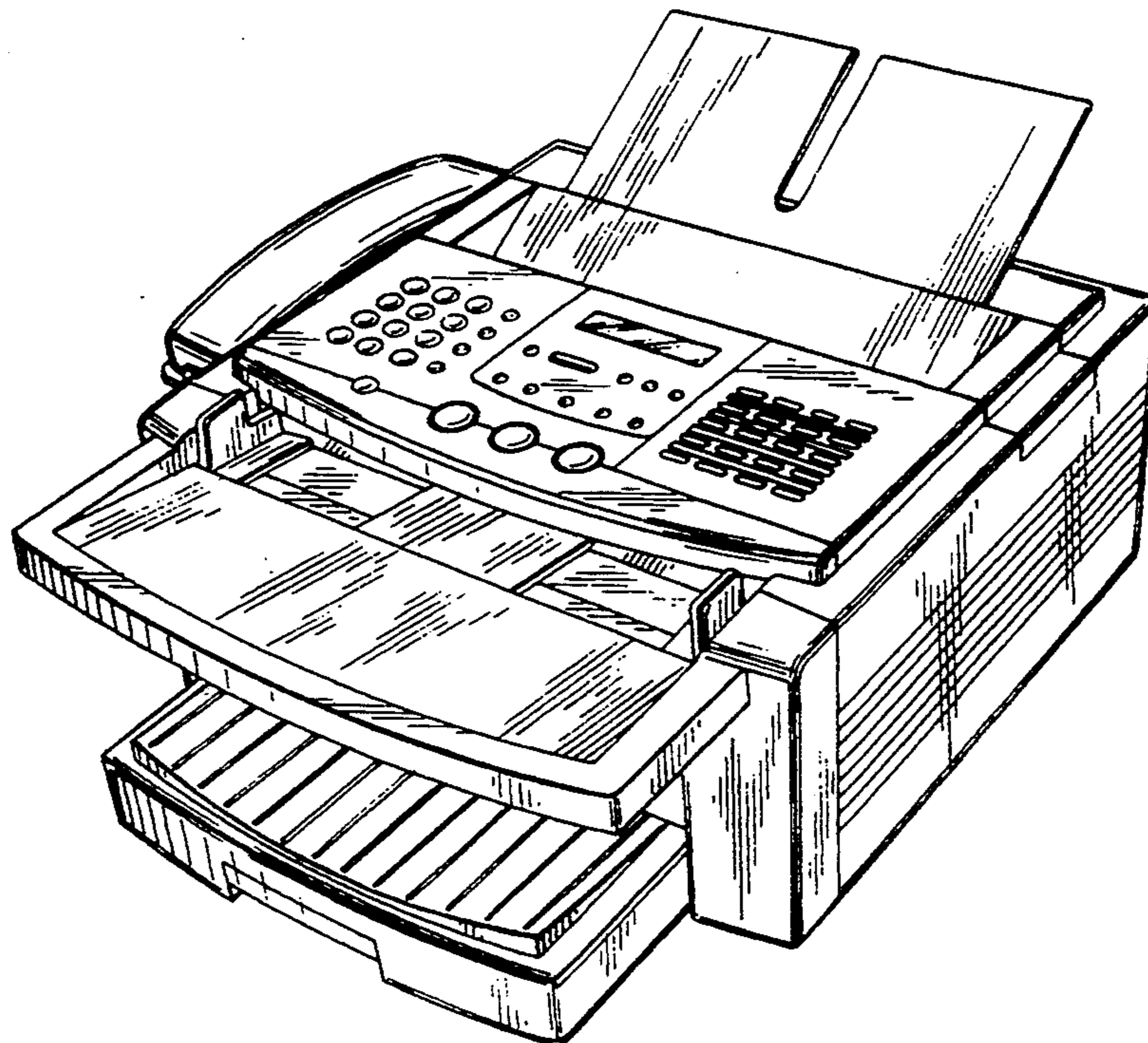

FIG. 1

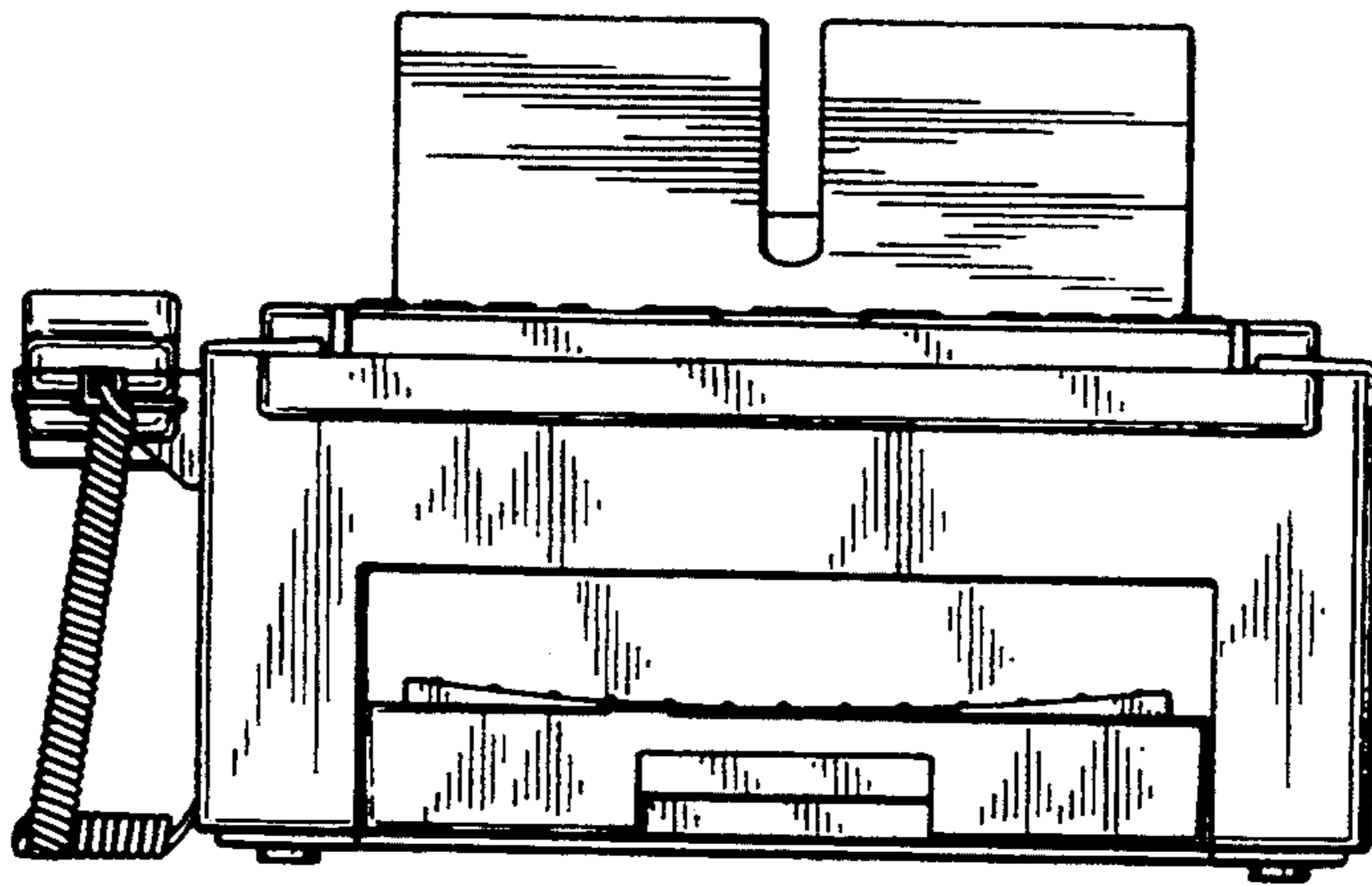

FIG. 2

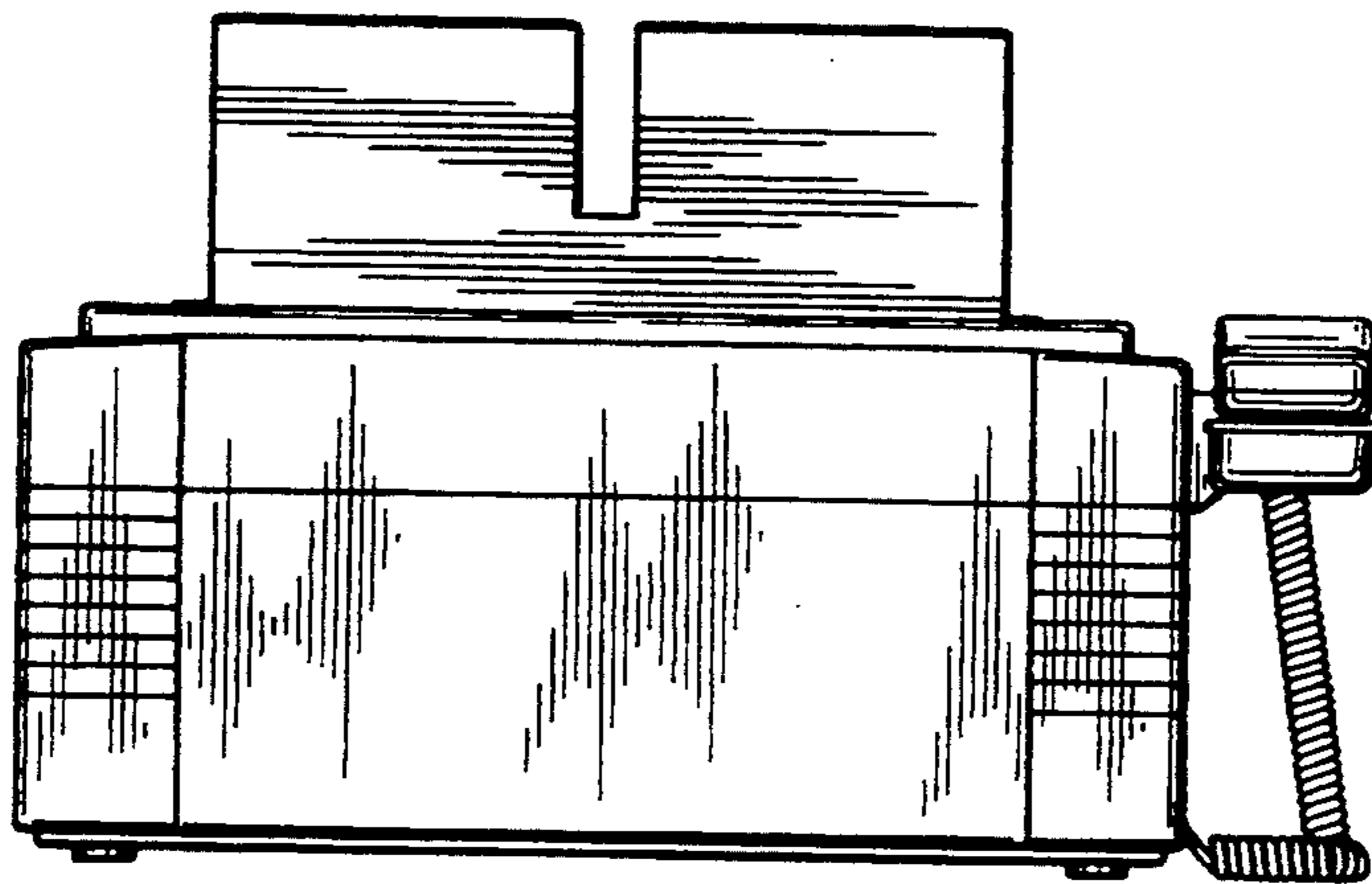

FIG. 3

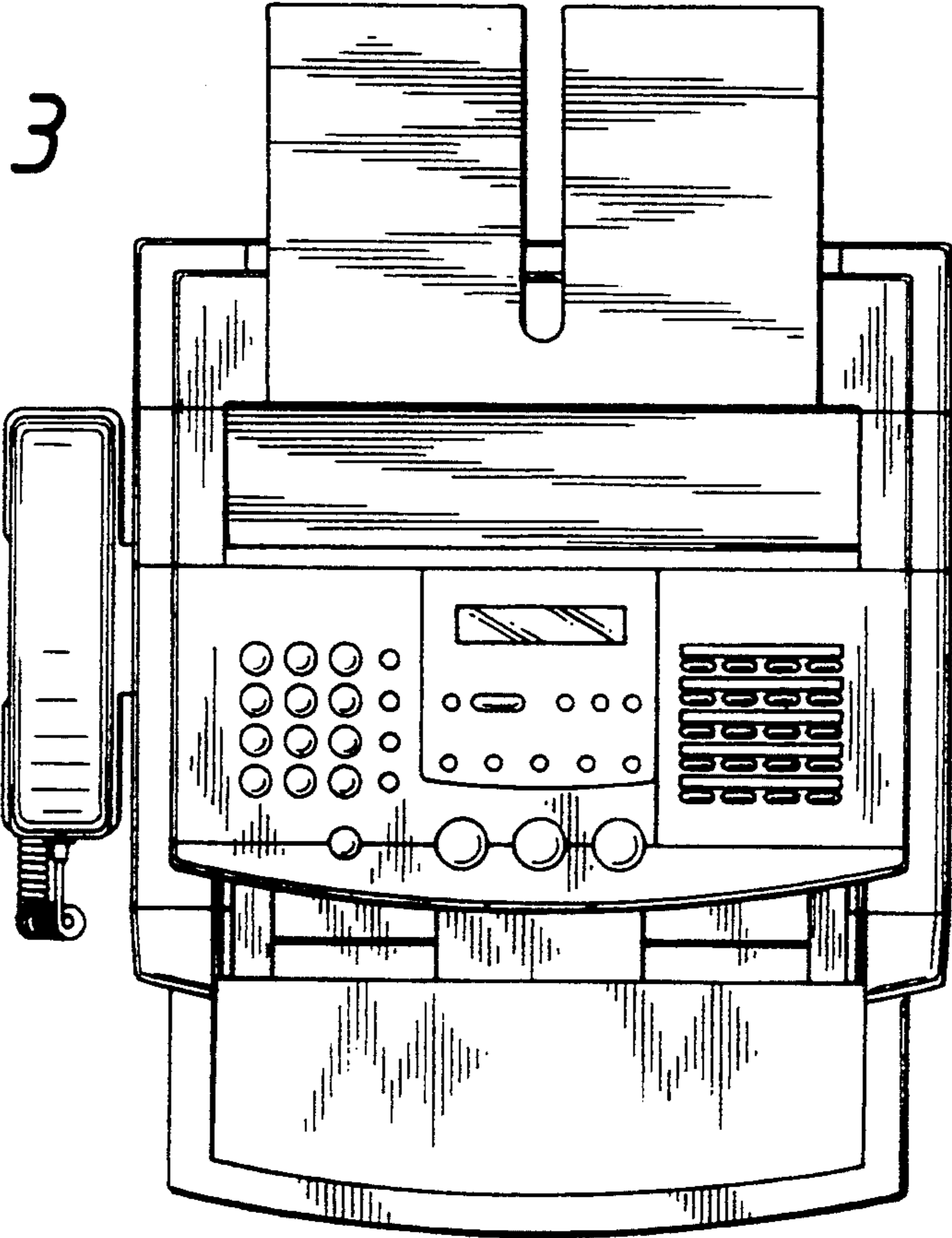

FIG. 4

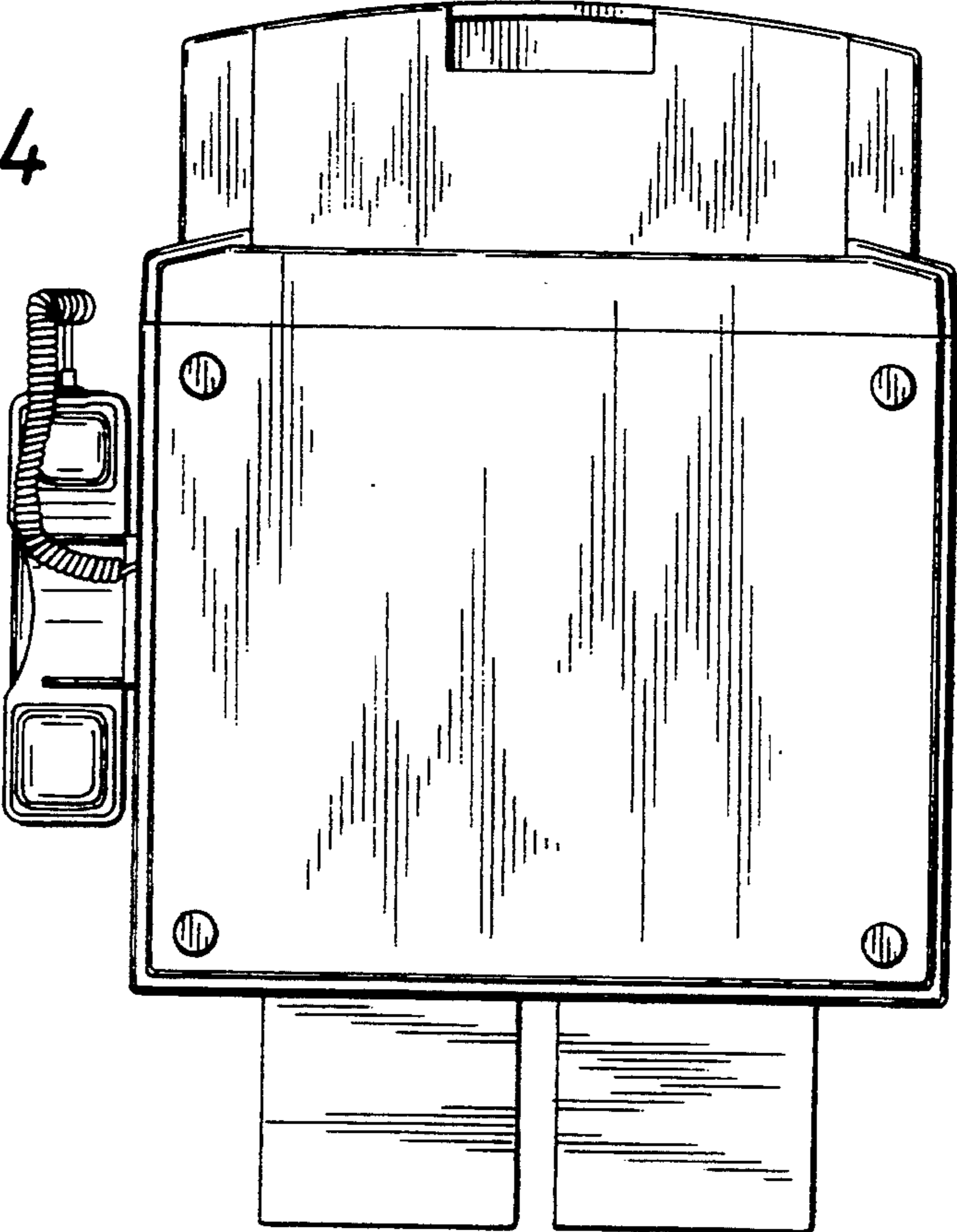

FIG. 5

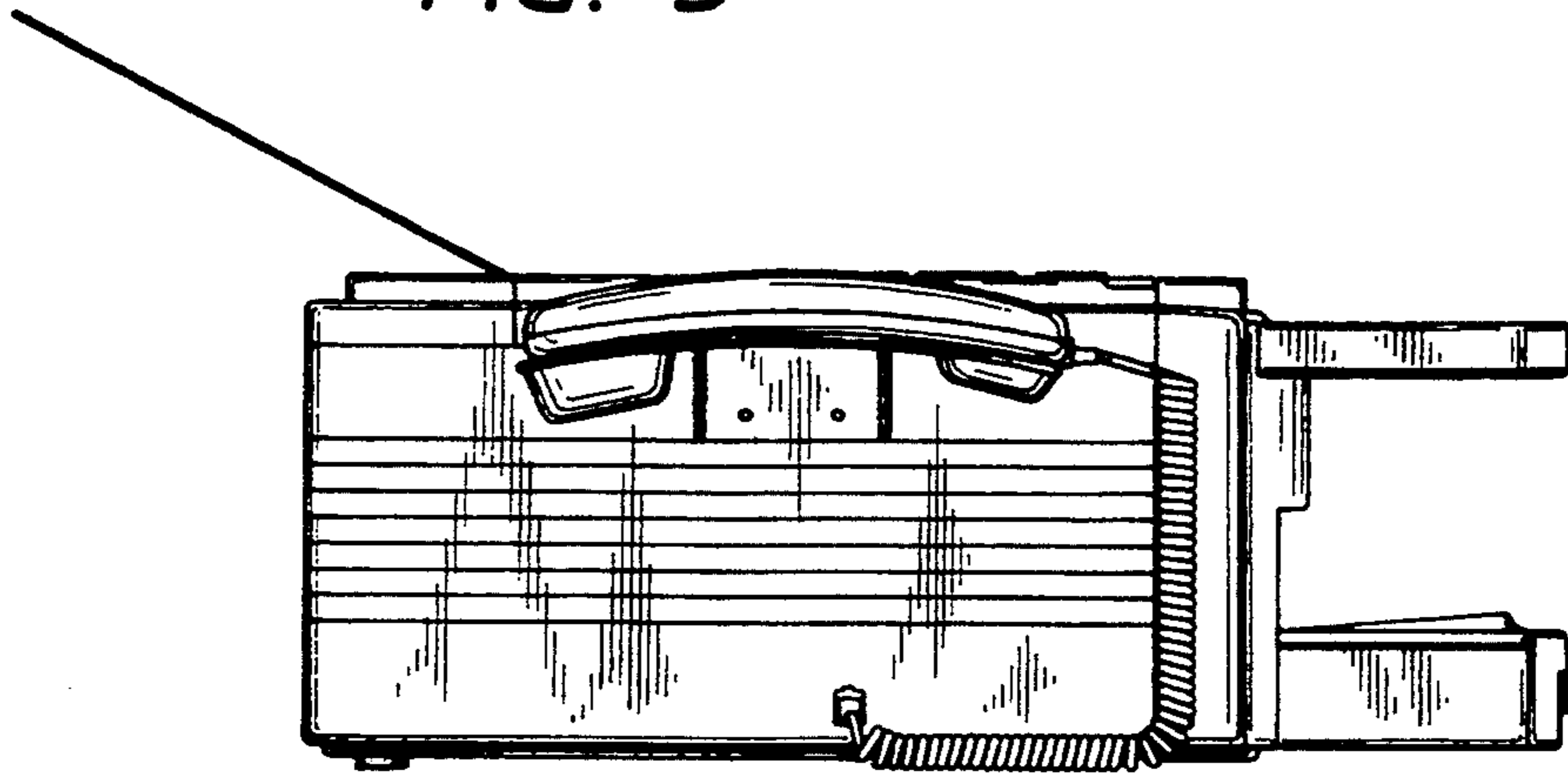

FIG. 6

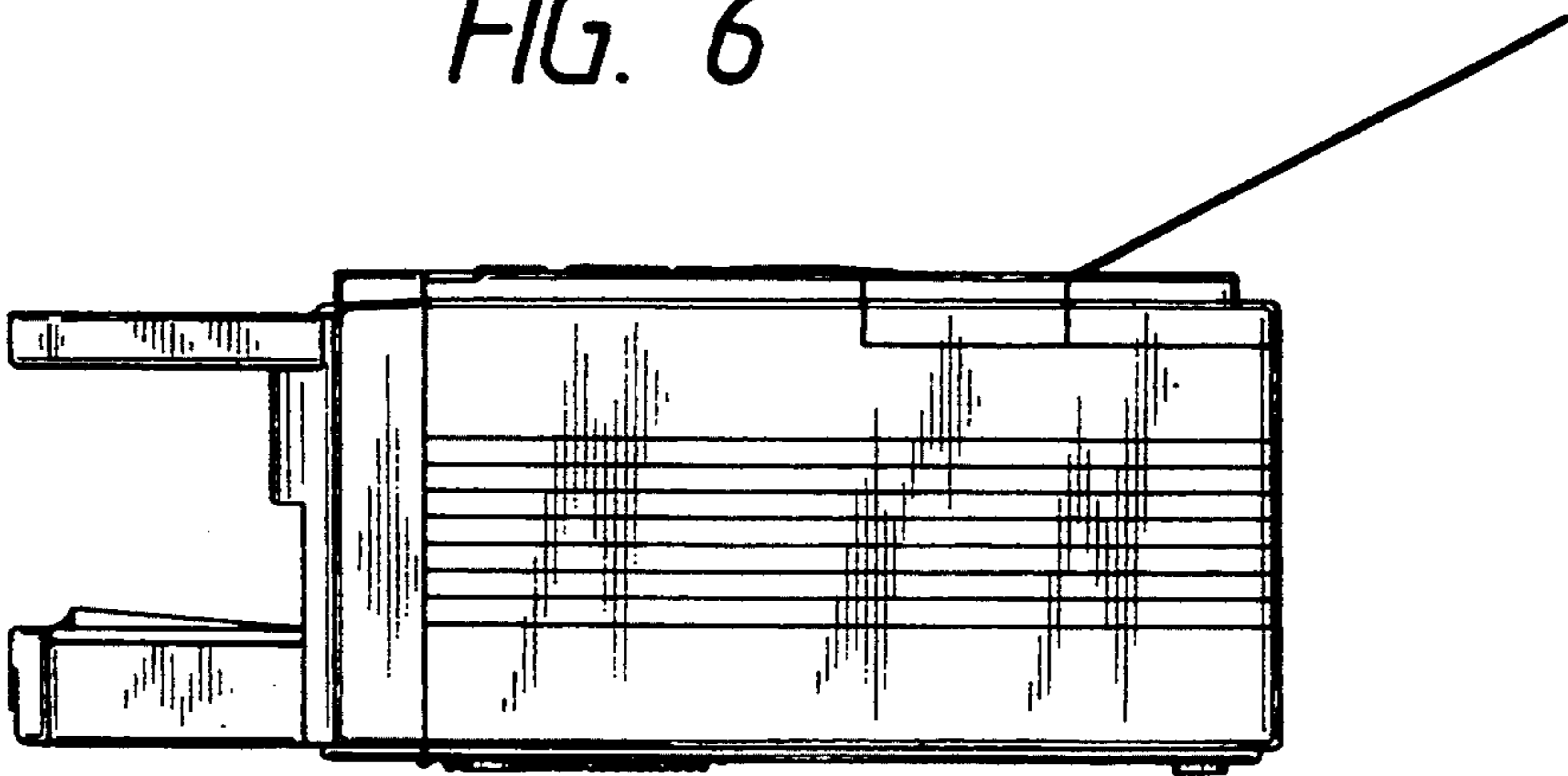

FIG. 7

