



US00D355772S

United States Patent [19]

[11] Patent Number: **Des. 355,772**

Chin et al.

[45] Date of Patent: **** Feb. 28, 1995**

[54] **CHILD'S CHAIR**

[75] Inventors: **Henry Y. Chin; Robert Dillon**, both of Portland, Oreg.; **Stacy L. Wolff**, Akron, Ohio

[73] Assignee: **Rubbermaid Incorporated**, Wooster, Ohio

[**] Term: **14 Years**

[21] Appl. No.: **17,428**

[22] Filed: **Jan. 13, 1994**

[52] U.S. Cl. **D6/333; D6/334; D6/368**

[58] Field of Search **D6/333, 334, 335, 339, D6/367, 368; 297/148-150, 250.1, 253, 254, 255**

[56] **References Cited**

U.S. PATENT DOCUMENTS

D. 79,320	9/1929	Anderson	D6/367
D. 141,231	5/1945	Walker, Jr.	D6/368
D. 145,074	6/1946	Glutsman	D6/367 X
D. 155,023	8/1949	Michals	D6/334
D. 155,880	11/1949	Erwin	D15/1
D. 239,746	5/1976	Narduzzi	D6/75
D. 263,435	3/1982	Deconinck	D6/70
D. 269,653	7/1983	Deconinck	D6/56

D. 276,106	10/1984	Grosfillex	D6/368
D. 284,913	8/1986	Deconinck	D6/368
D. 288,871	3/1987	Hubert	D6/368
2,703,135	3/1955	Leatherman	155/2
4,319,779	3/1982	Leonhart	297/19

OTHER PUBLICATIONS

Catalog page; Folding and multiposition chairs; Allibert Contract, Rubbermaid-Allibert Inc., 1200 Highway 27 South, Stanley, North Carolina 28164. Publication date 1991.

Primary Examiner—Janice E. Seeger

Attorney, Agent, or Firm—Richard B. O'Planick; Lisa B. Riedesel

[57] **CLAIM**

The ornamental design for a child's chair, as shown and described.

DESCRIPTION

FIG. 1 is a top right front perspective view of a child's chair showing our new design; FIG. 2 is a front elevational view thereof; FIG. 3 is a left side elevational view thereof; the right side elevational view being a mirror image; FIG. 4 is a top plan view thereof; FIG. 5 is a rear elevational view thereof; and, FIG. 6 is a bottom plan view thereof.

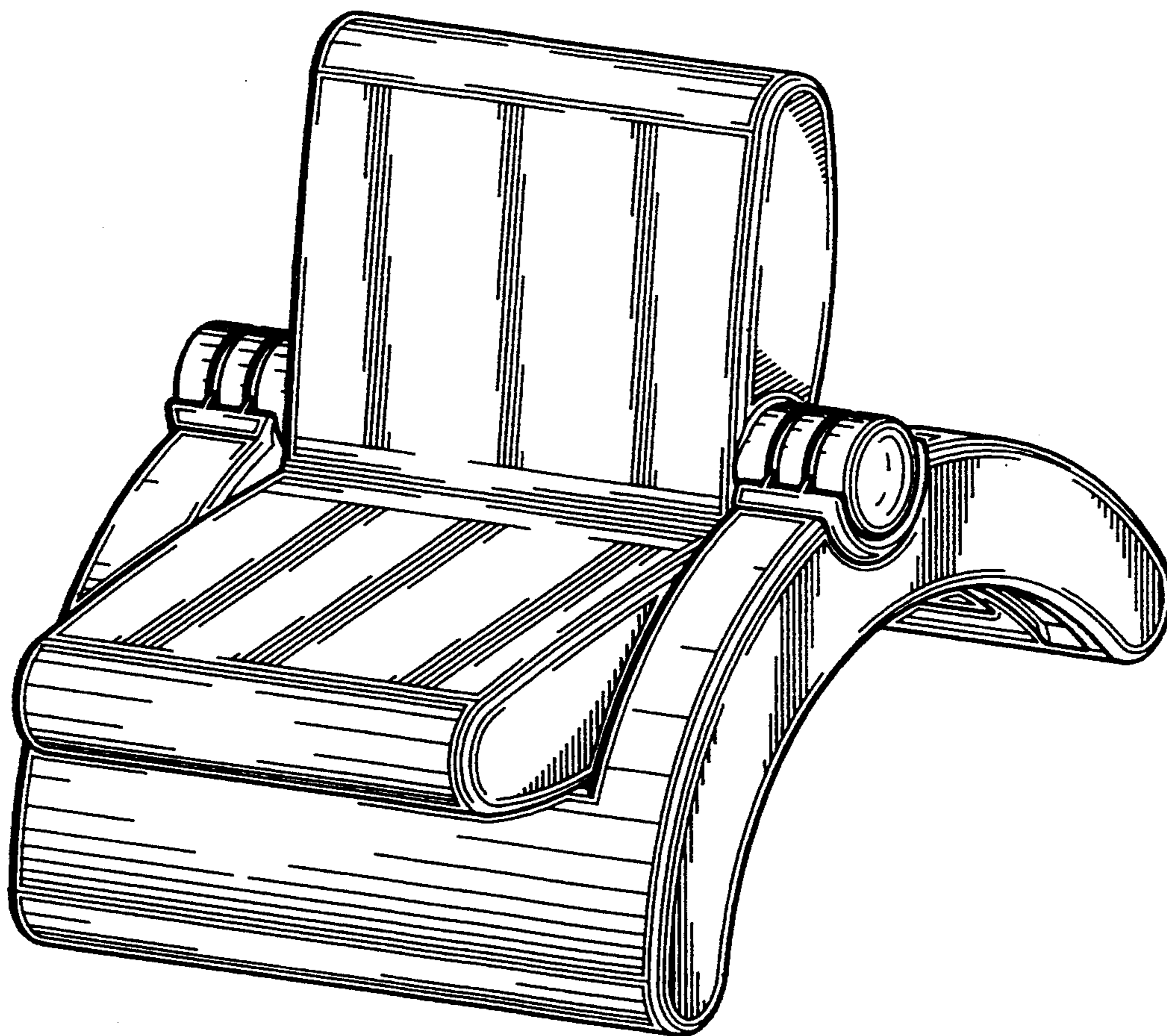

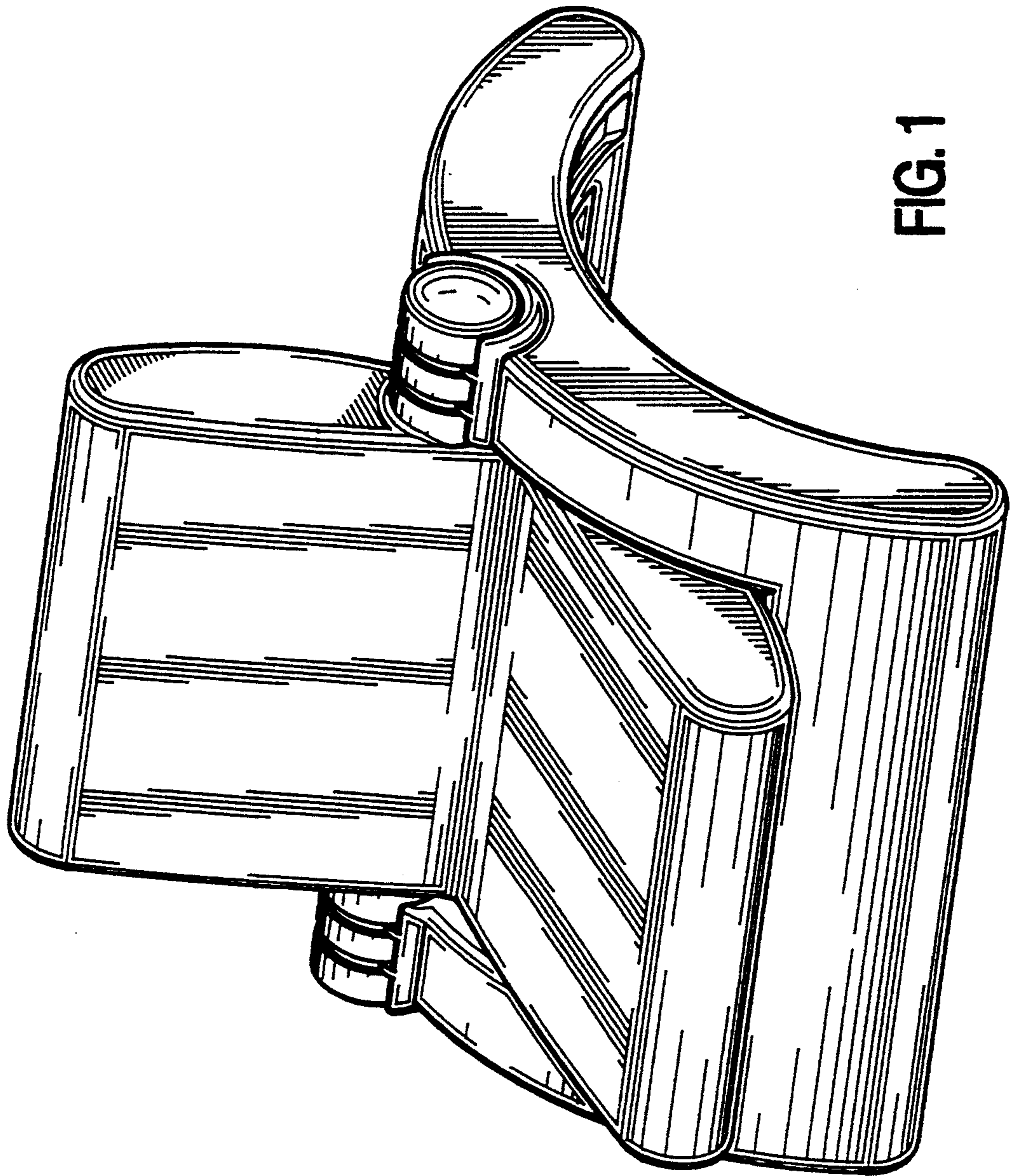

FIG. 1

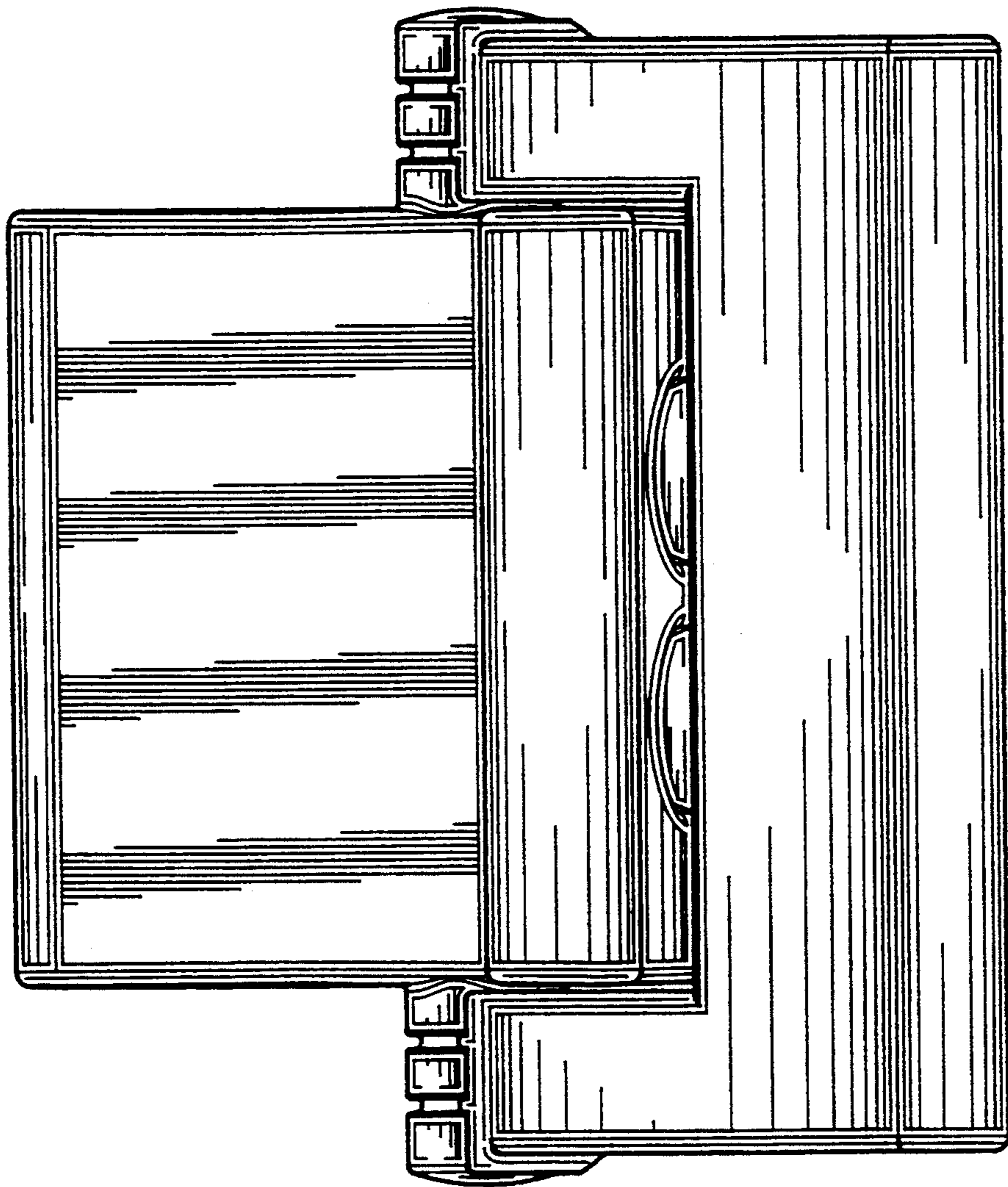

FIG. 2

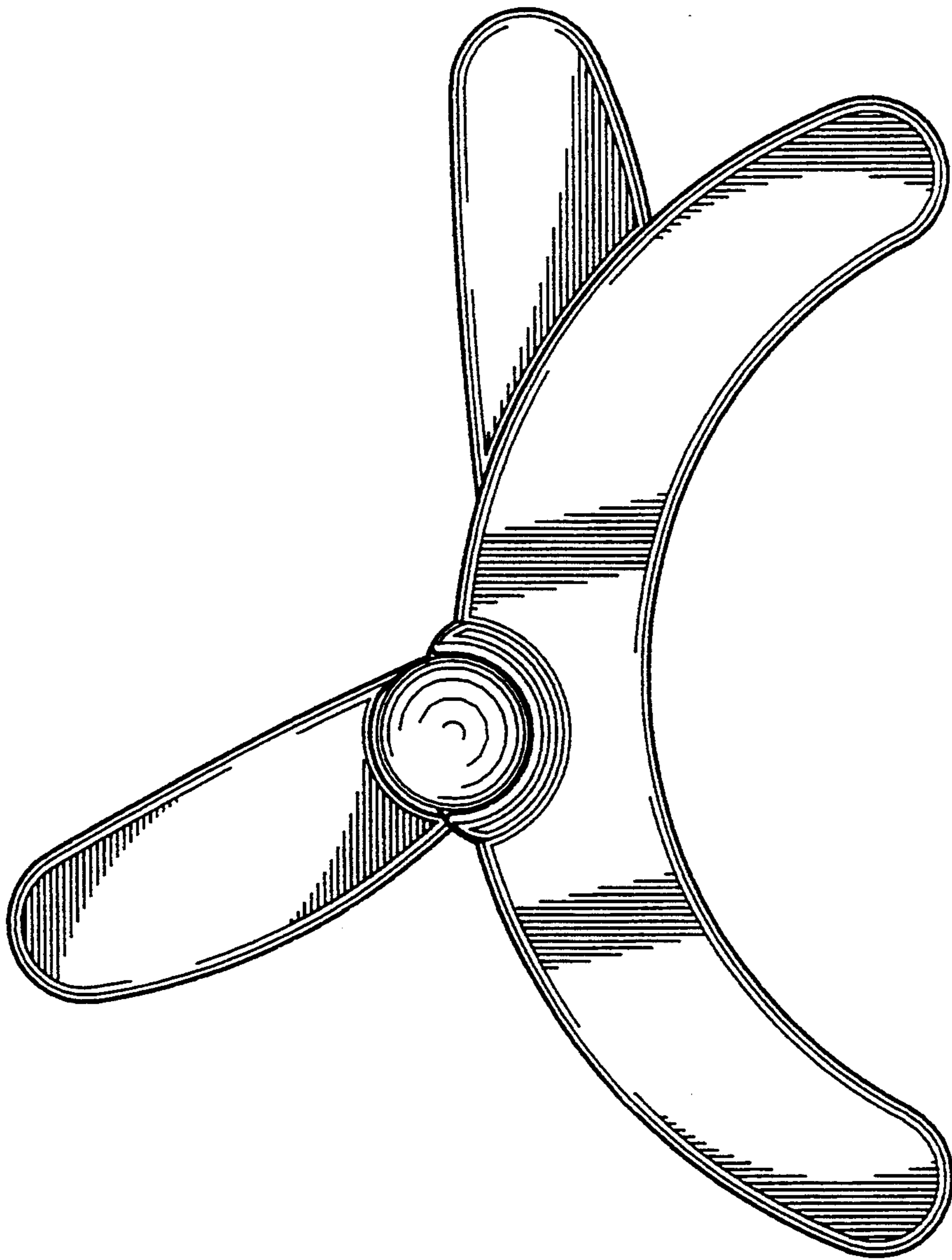

FIG. 3

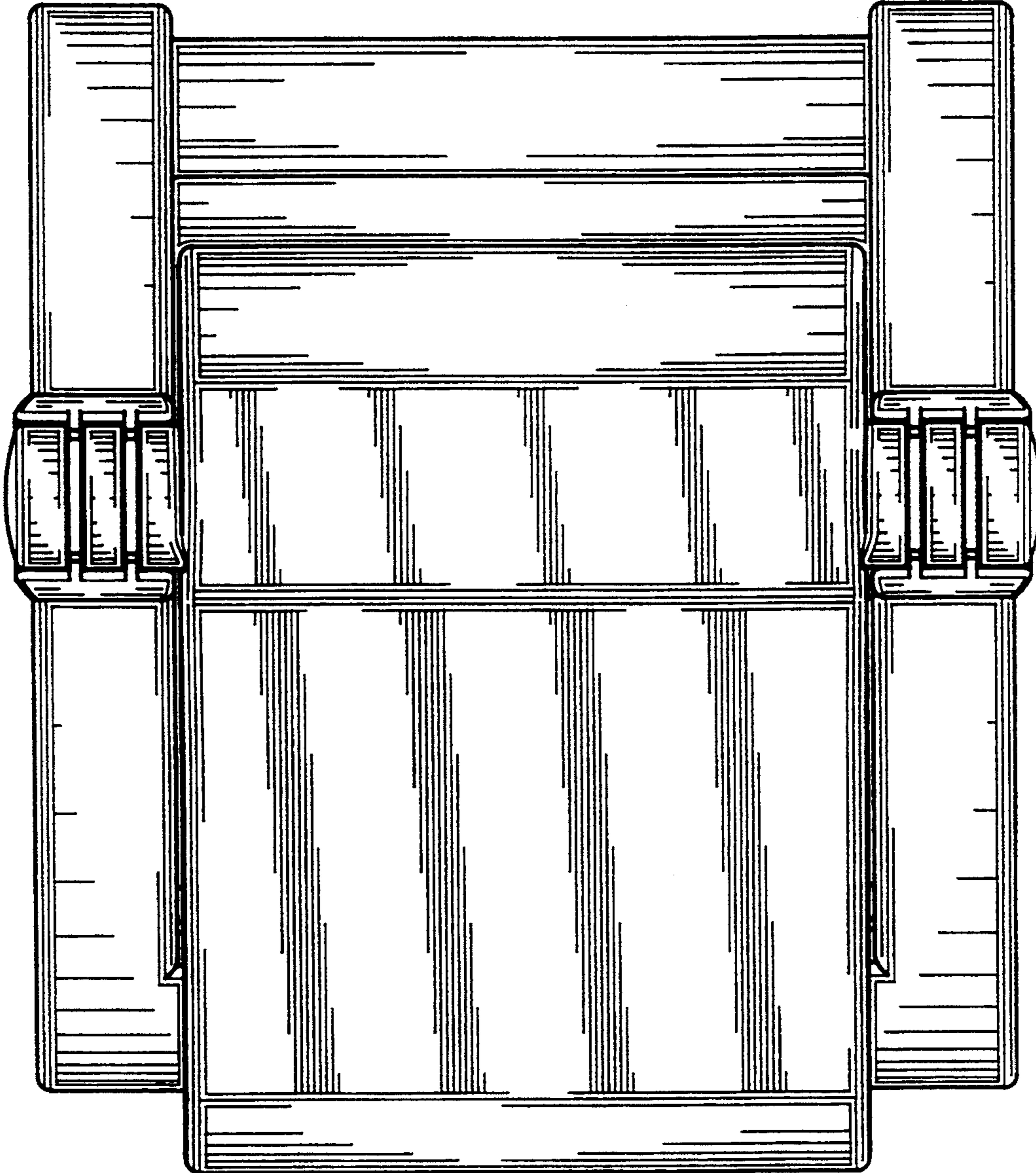

FIG. 4

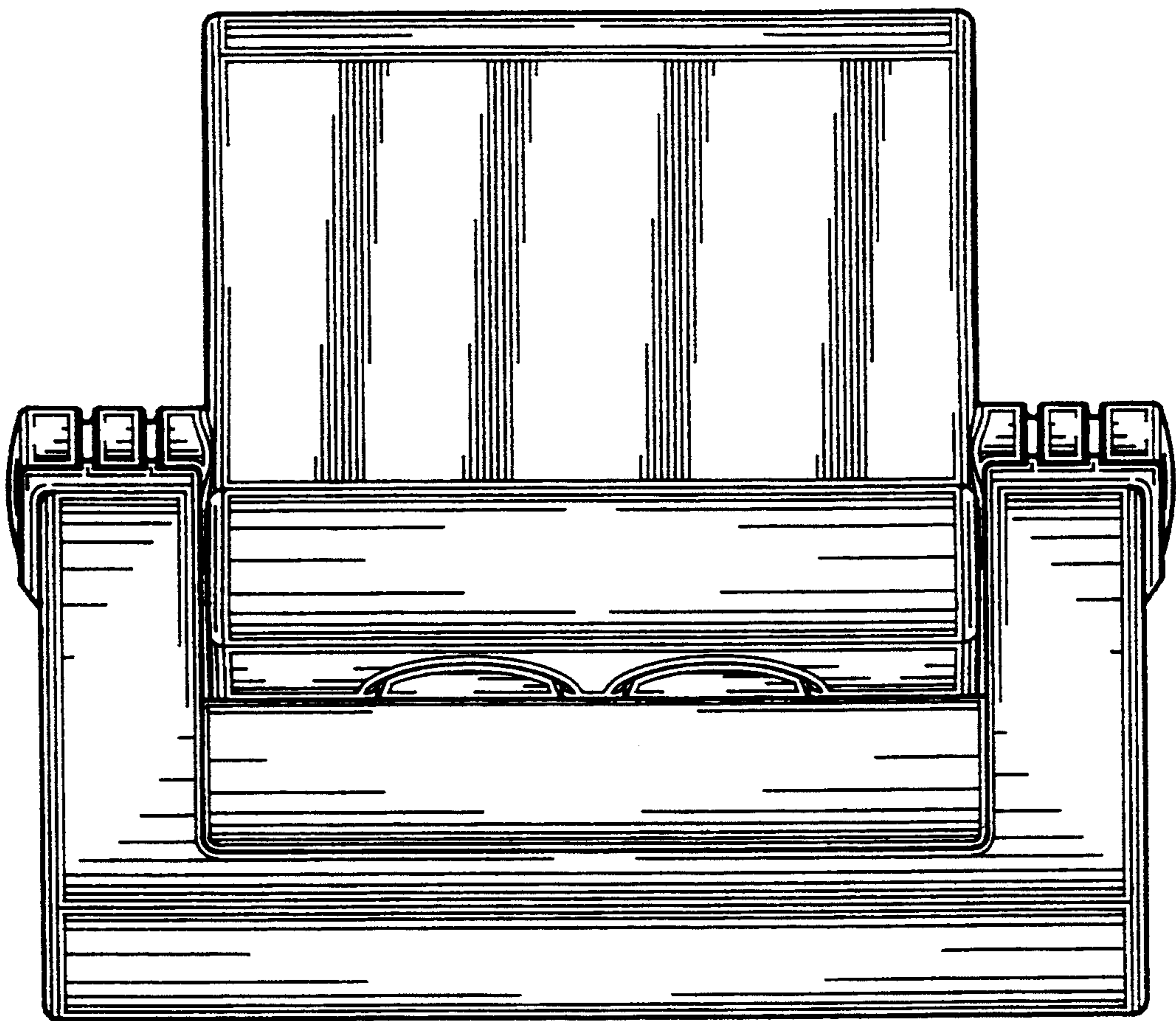

FIG. 5

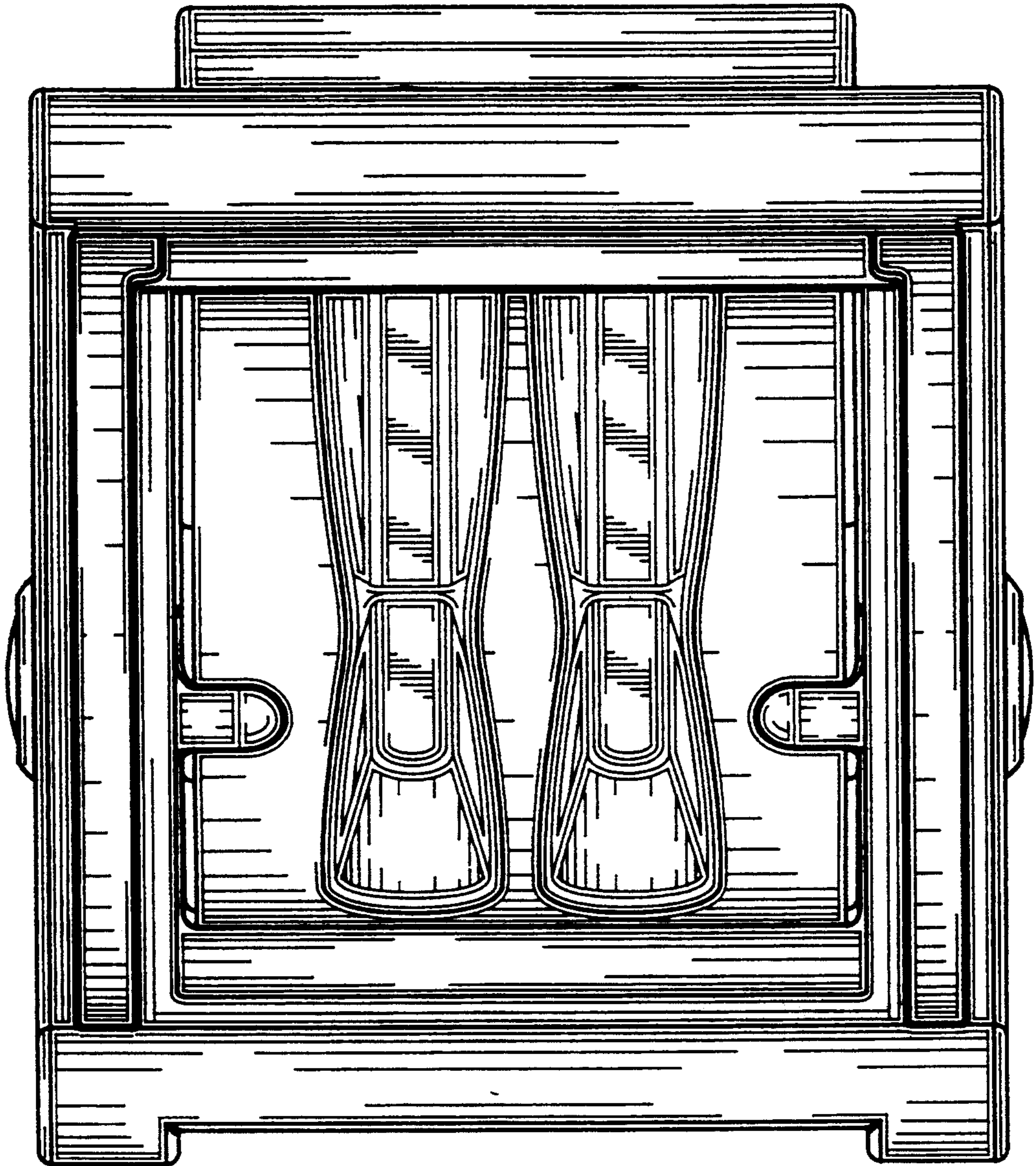

FIG. 6