



US00D355760S

United States Patent [19]

[11] Patent Number: **Des. 355,760**

Sanfilippo

[45] Date of Patent: **** Feb. 28, 1995**

[54] **COMBINATION FISHING TOOL AND BAIT BOX CONTAINER**

FOREIGN PATENT DOCUMENTS

452155 3/1913 France 217/62

[76] Inventor: **Robert M. Sanfilippo**, 3424 Alice St., Los Angeles, Calif. 90065

OTHER PUBLICATIONS

Johnny Morris White River Fly Shop Catalog ©1992 Fly Tying Desk "K".

[**] Term: **14 Years**

Primary Examiner—A. Hugo Word
Assistant Examiner—Doris V. Coles
Attorney, Agent, or Firm—Frederick Gotha

[21] Appl. No.: **6,354**

[22] Filed: **Mar. 26, 1993**

[52] U.S. Cl. **D3/260; D22/136**

[58] Field of Search **D3/260, 905, 215; 22/136; D6/406, 419; 43/55; 206/315.11, 315.1; 217/59, 62**

[57] CLAIM

The ornamental design for a combination fishing tool and bait box container, as shown and described.

[56] References Cited

U.S. PATENT DOCUMENTS

404,880	6/1889	Wheat	217/62
1,325,349	12/1919	Burgess	217/62
2,532,083	11/1950	Brenner	217/62
2,544,049	3/1951	Sawner	43/55
3,954,172	5/1976	Rinella	43/55 X
4,000,577	1/1977	Kelley	43/55
4,597,122	7/1986	Handler et al.	217/62 X

DESCRIPTION

FIG. 1 is a perspective view of a combination fishing tool and bait box container showing my new design; FIG. 2 is a top plan view thereof; FIG. 3 is a front elevational view thereof; FIG. 4 is a right side elevational view thereof; FIG. 5 is a bottom plan view thereof; FIG. 6 is a left side elevational view thereof; and, FIG. 7 is a rear elevational view of my new design.

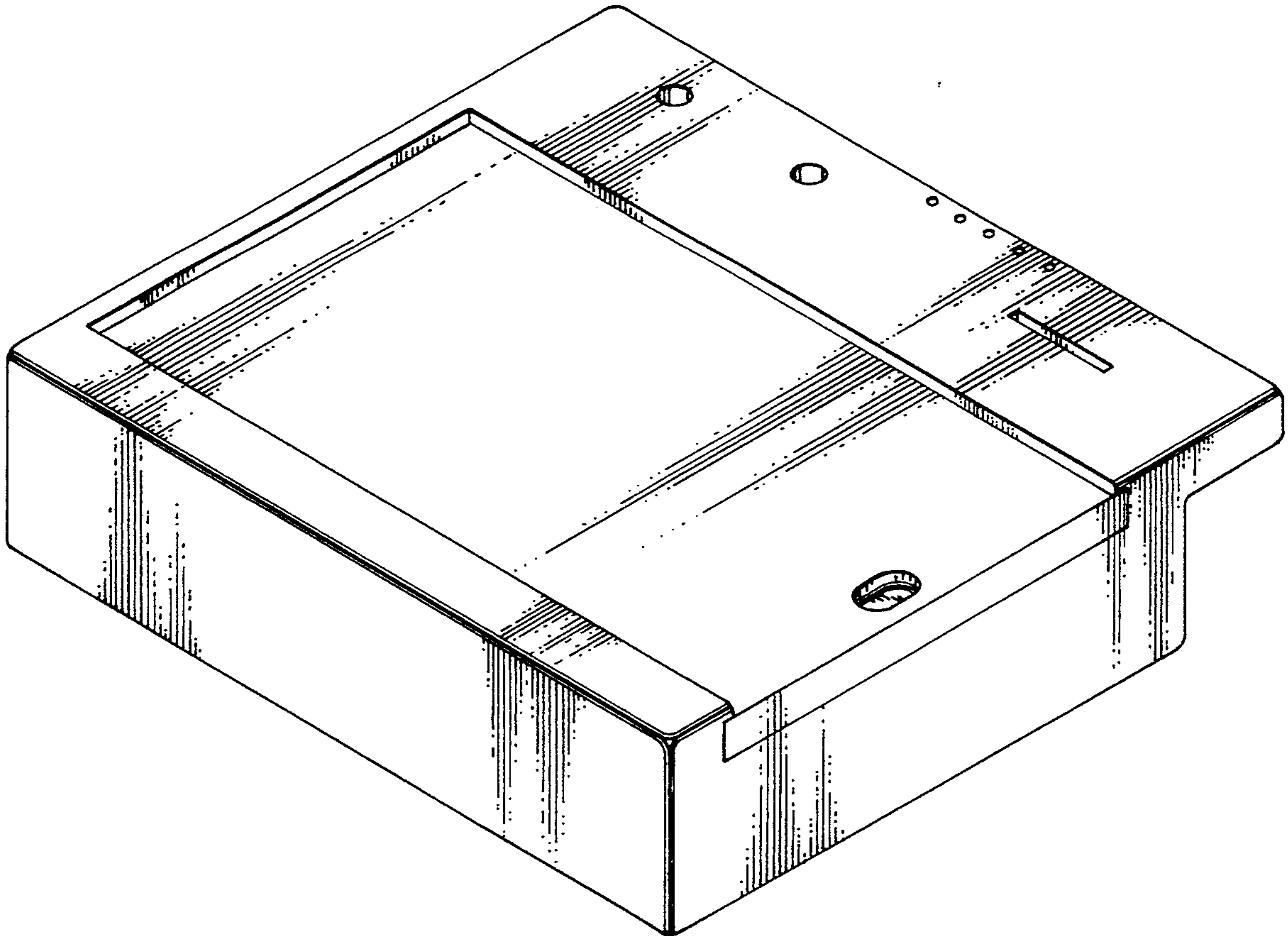

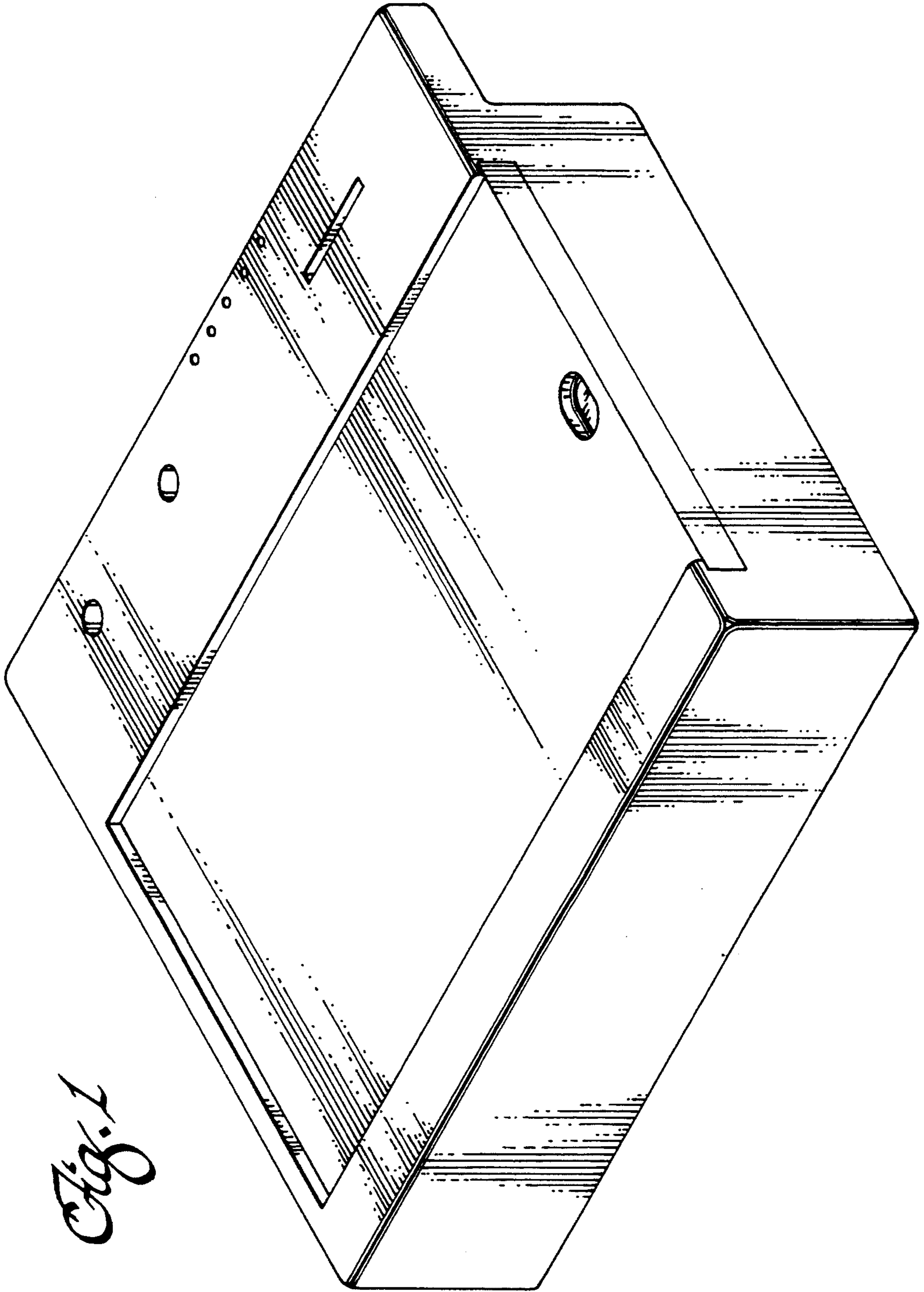

Fig. 1

Fig. 2

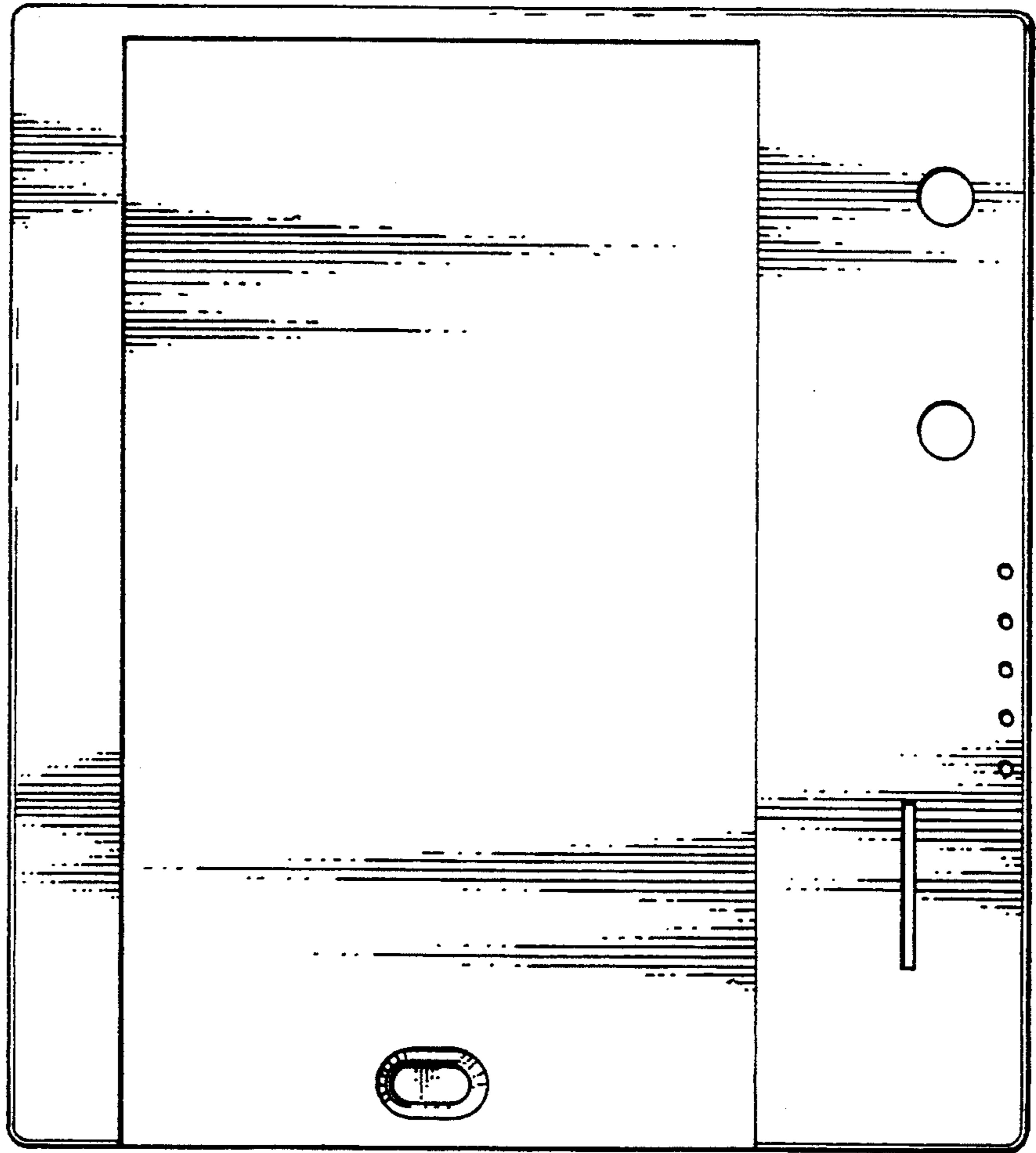

Fig. 3

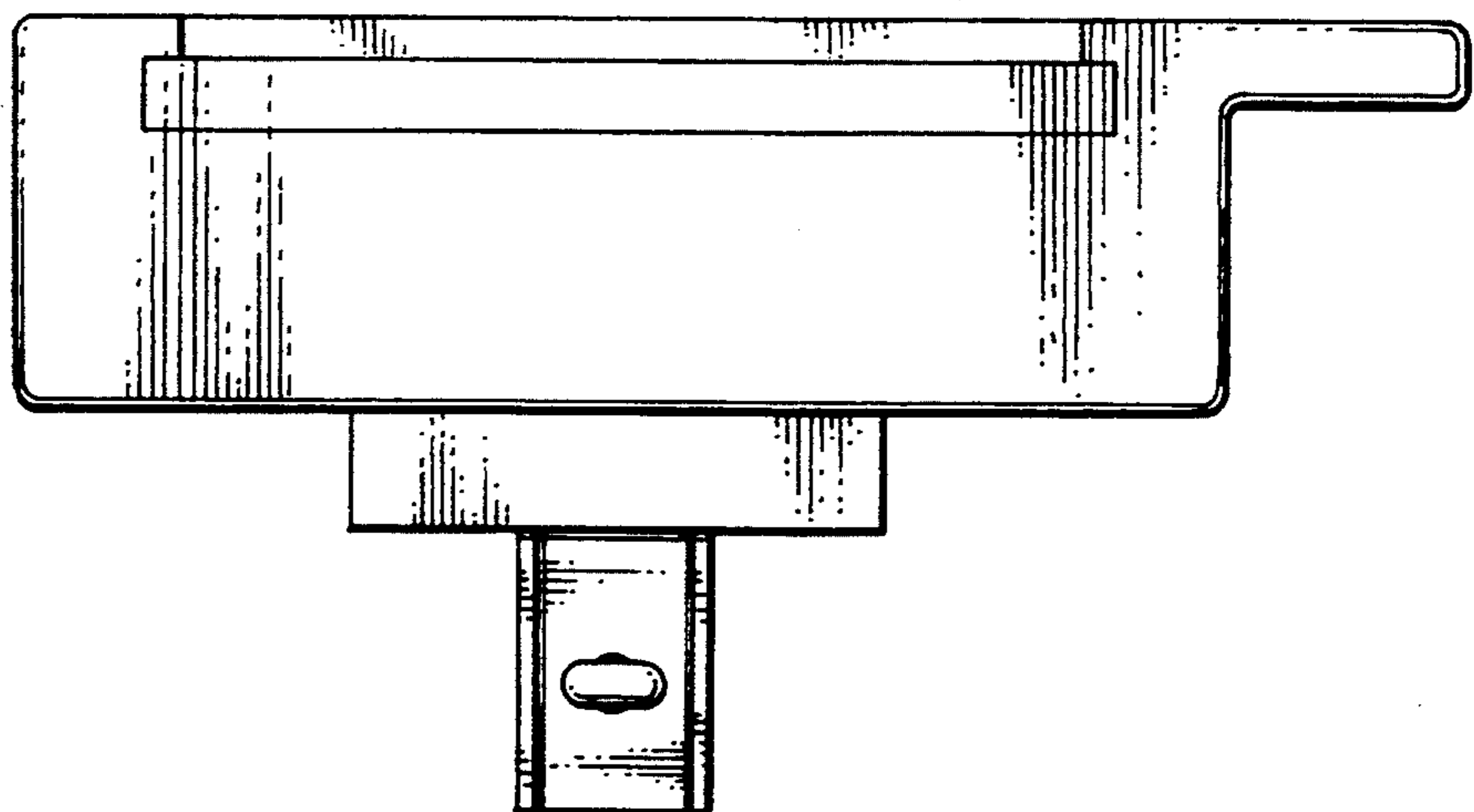

Fig. 4

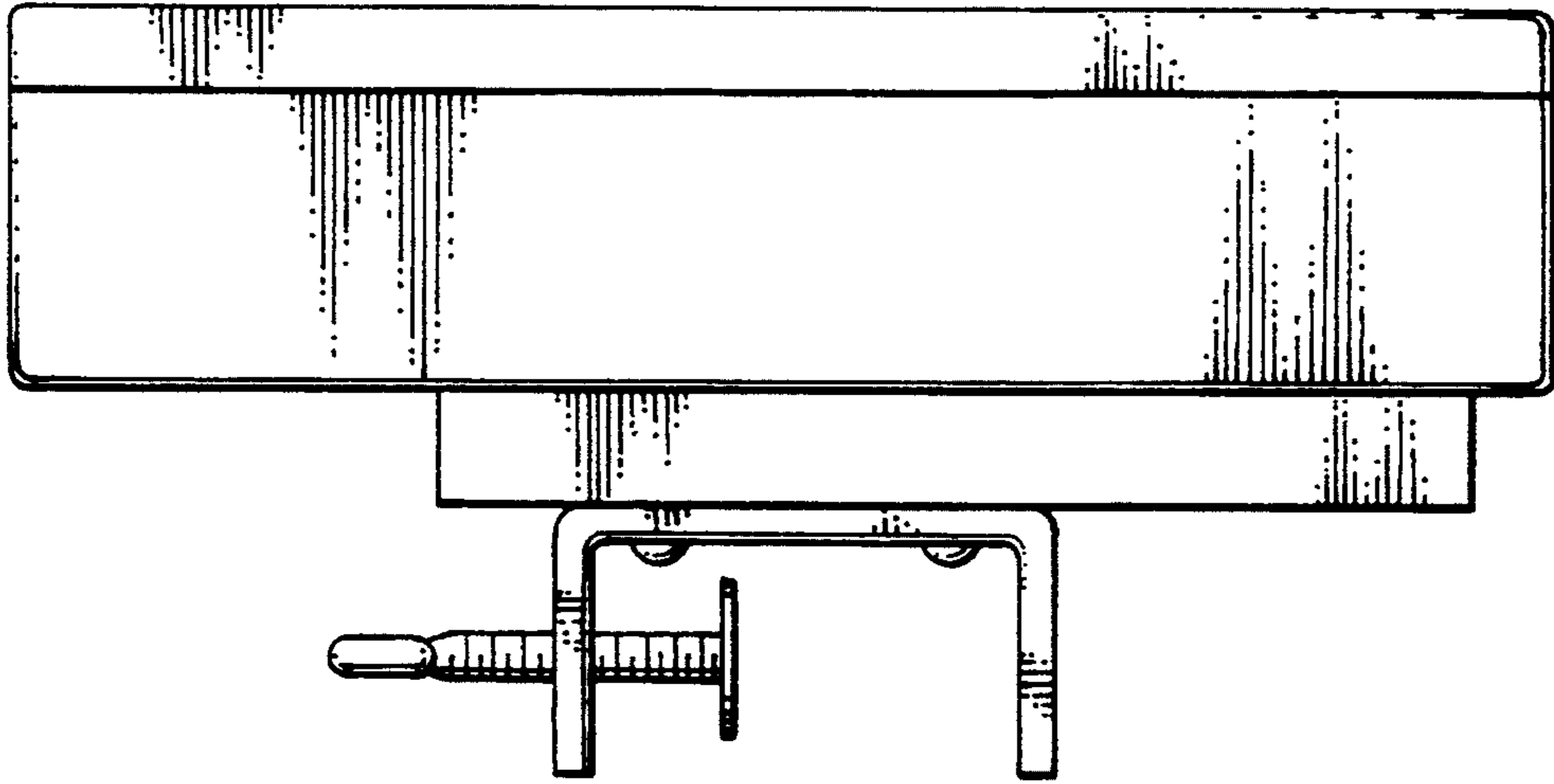

Fig. 5

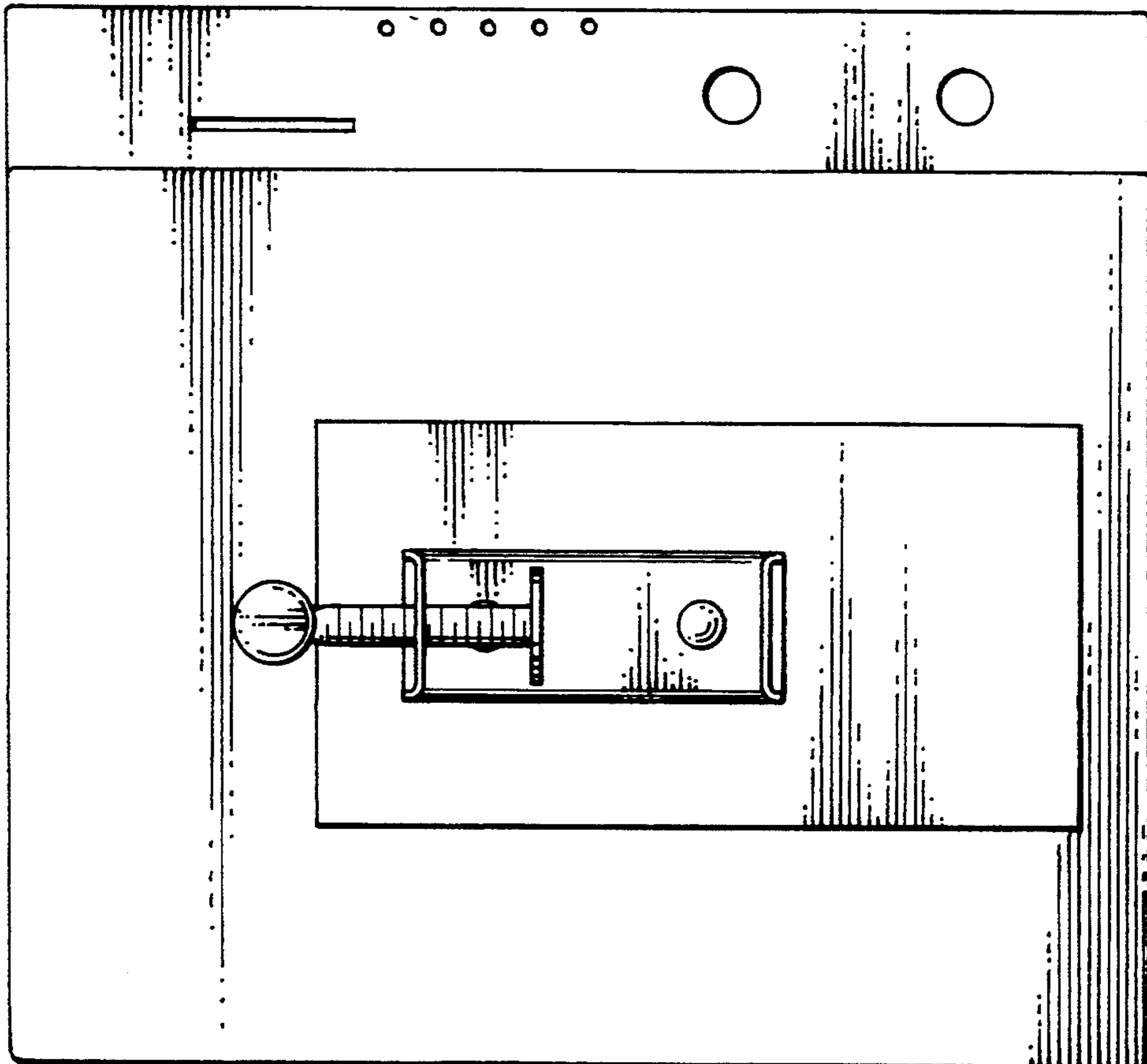

Fig. 6

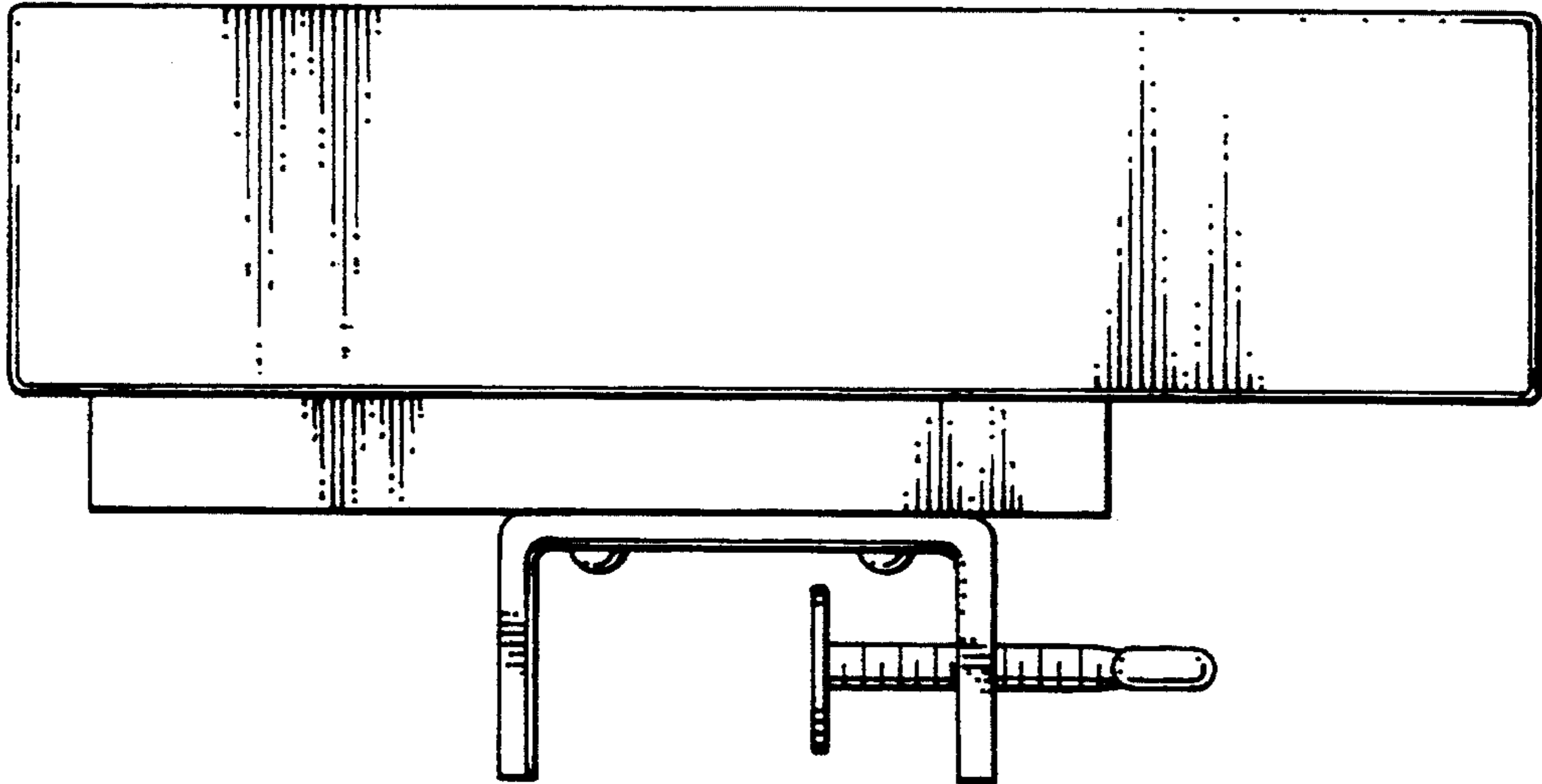

Fig. 7

