



US00D355735S

# United States Patent [19]

[11] Patent Number: **Des. 355,735**

Shaffer et al.

[45] Date of Patent: **\*\* Feb. 21, 1995**

## [54] COMBINED BUCKET WITH NESTED CONTAINERS AND LID THEREFOR

[76] Inventors: **David G. Shaffer**, 307 First St., Woodland, Calif. 95695; **Andrew A. Kephart**, 21 Buckeye St., Woodland, Calif. 95965

[\*\*] Term: **14 Years**

[21] Appl. No.: **754,687**

[22] Filed: **Sep. 4, 1991**

[52] U.S. Cl. .... **D32/53; D9/347; D9/503**

[58] Field of Search ..... **D9/341, 347, 428, 425, D9/503-504, 431; D32/53, 53.1, 54; 220/23.2, 23.4, 23.8, 23.83, 23.86, 426-427, 553-555; 206/499, 503, 505, 372-373**

## [56] References Cited

### U.S. PATENT DOCUMENTS

D. 317,120	5/1991	Schwartzburg	.....	D9/503
420,335	1/1890	Craig	.....	220/23.2 X
2,623,633	12/1952	Badlow	.....	206/509 X
3,751,845	8/1973	van Leeuwen	.....	43/56
4,162,875	7/1979	Lux et al.	.....	366/273
4,589,546	5/1986	Sunderland	.....	206/315.11
4,618,069	10/1986	Quong	.....	220/23.4
4,759,148	7/1988	Love	.....	43/54.1
4,834,262	5/1989	Reed	.....	220/404
4,845,881	7/1989	Ward	.....	43/21.1
4,911,295	3/1990	Venagoni	.....	206/372
4,999,943	3/1991	Crabtree	.....	43/54.1
5,154,303	10/1992	Jordan	.....	220/23.86

*Primary Examiner*—James M. Gandy  
*Assistant Examiner*—Lavone D. Tabor  
*Attorney, Agent, or Firm*—Bernhard Kreten

## [57] CLAIM

The ornamental design for a combined bucket with

nested containers and lid therefor, as shown and described.

## DESCRIPTION

FIG. 1 is an exploded perspective view of a combined bucket with nested containers and lid therefor showing our new design;

FIG. 2 is a perspective view thereof in its assembled condition.

FIG. 3 is a top view thereof;

FIG. 4 is a bottom view of the lid;

FIG. 5 is a side view thereof, the opposite side, front and rear being the same in appearance as the side shown;

FIG. 6 is a top view of the first container;

FIG. 7 is a bottom view thereof;

FIG. 8 is a side view thereof, the opposite side, front and rear being the same in appearance as the side shown;

FIG. 9 is a top view of the second container;

FIG. 10 is a bottom view thereof;

FIG. 11 is a side view thereof, the opposite side, front and rear being the same in appearance as the side shown;

FIG. 12 is top view of the third container;

FIG. 13 is bottom view thereof;

FIG. 14 is a side view thereof, the opposite side, front, and rear being the same in appearance as the side shown;

FIG. 15 is a top view of the bucket;

FIG. 16 is a bottom view thereof; and,

FIG. 17 is a side view thereof, the opposite side, front, and rear being the same in appearance as the side shown.

The portions of the claimed design shown in FIGS. 4-17 are shown separately for clarity of illustration only.

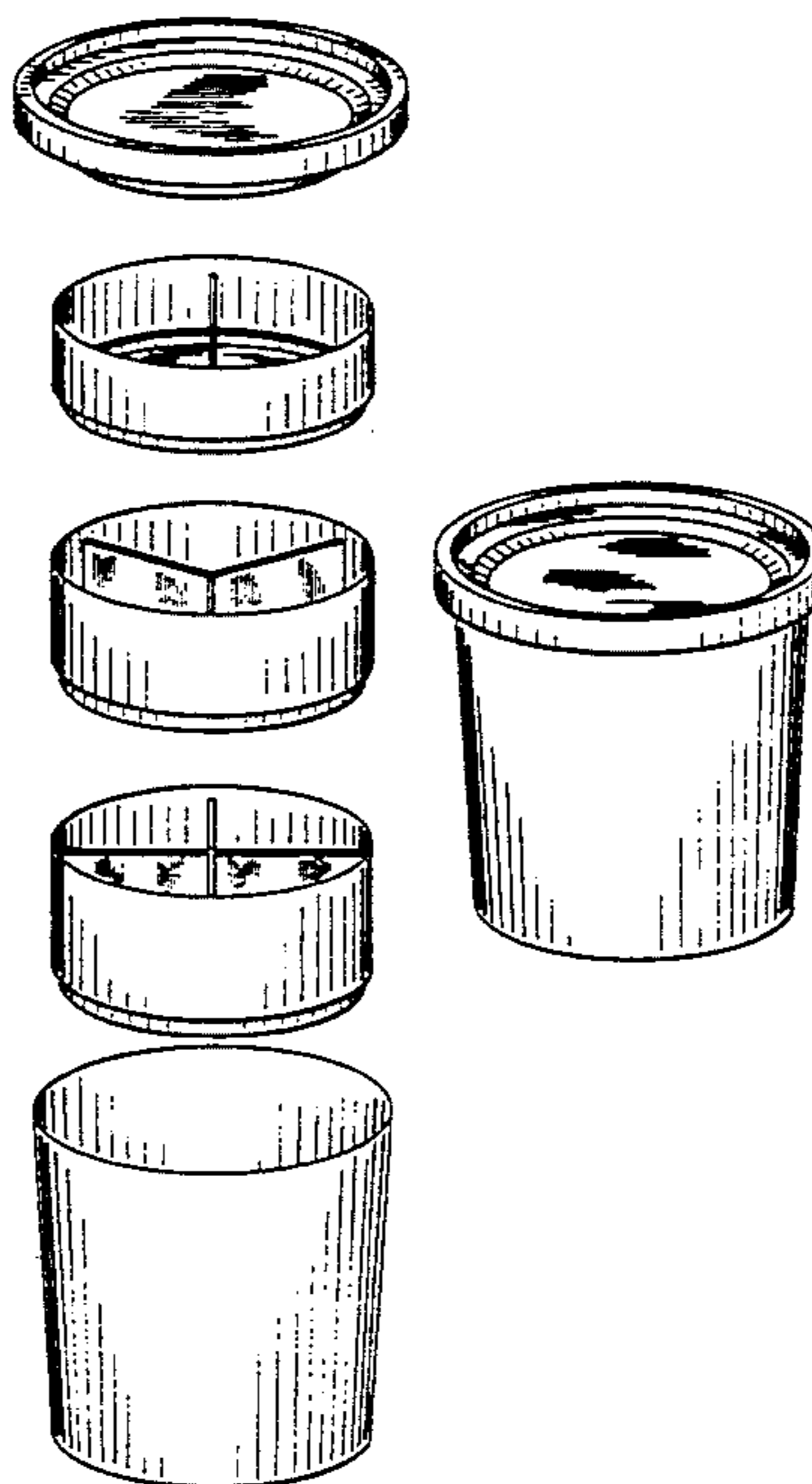

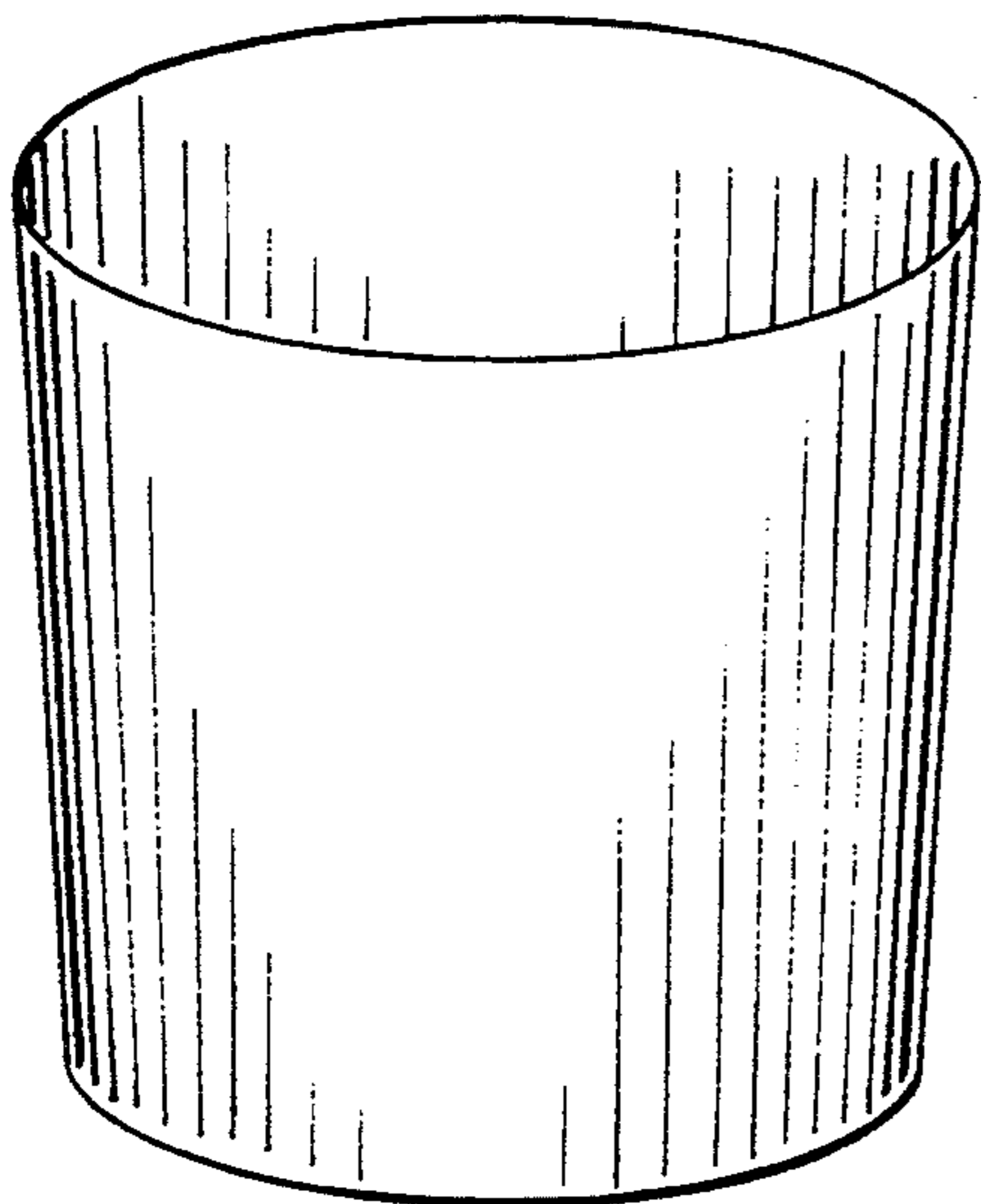
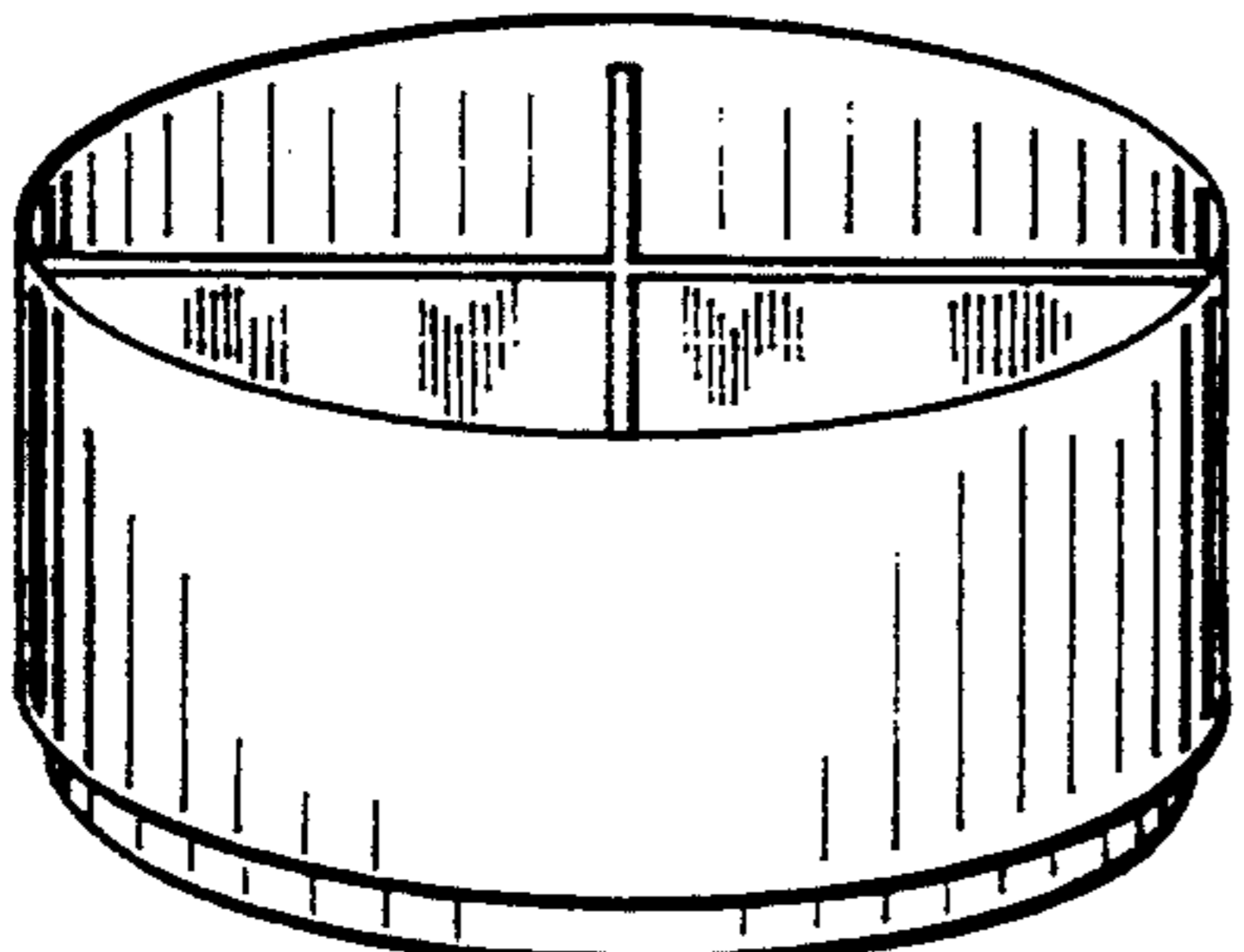
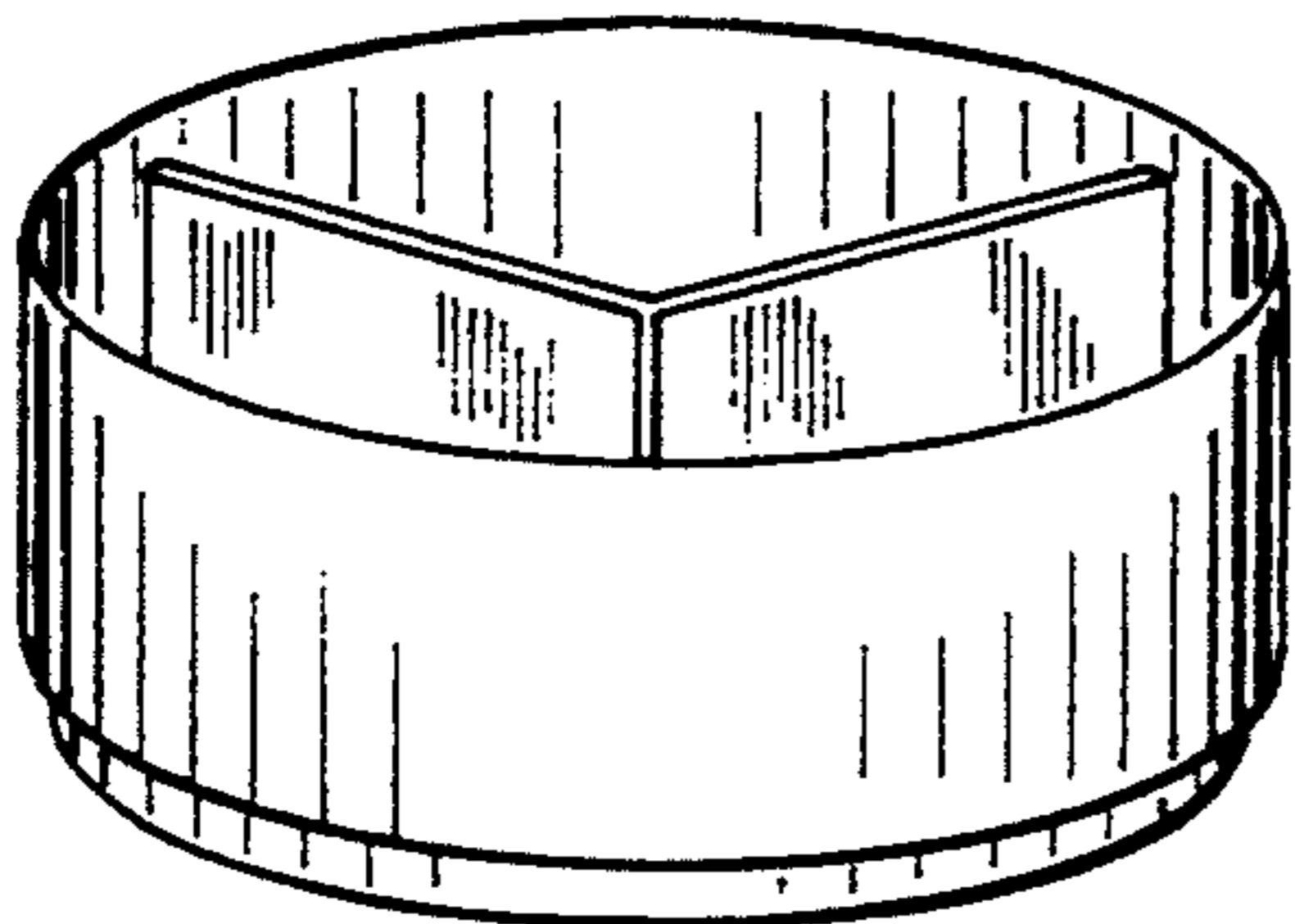
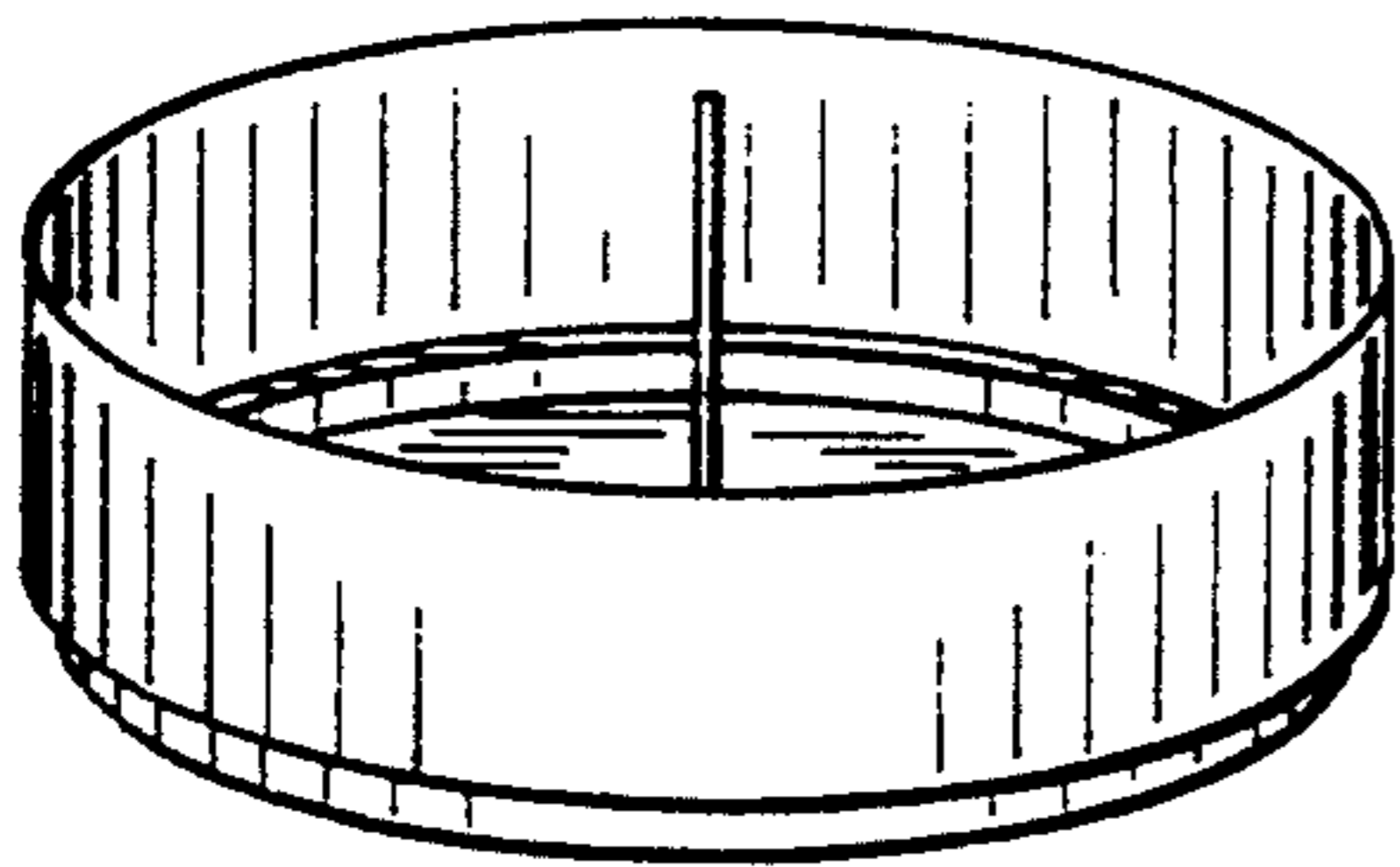
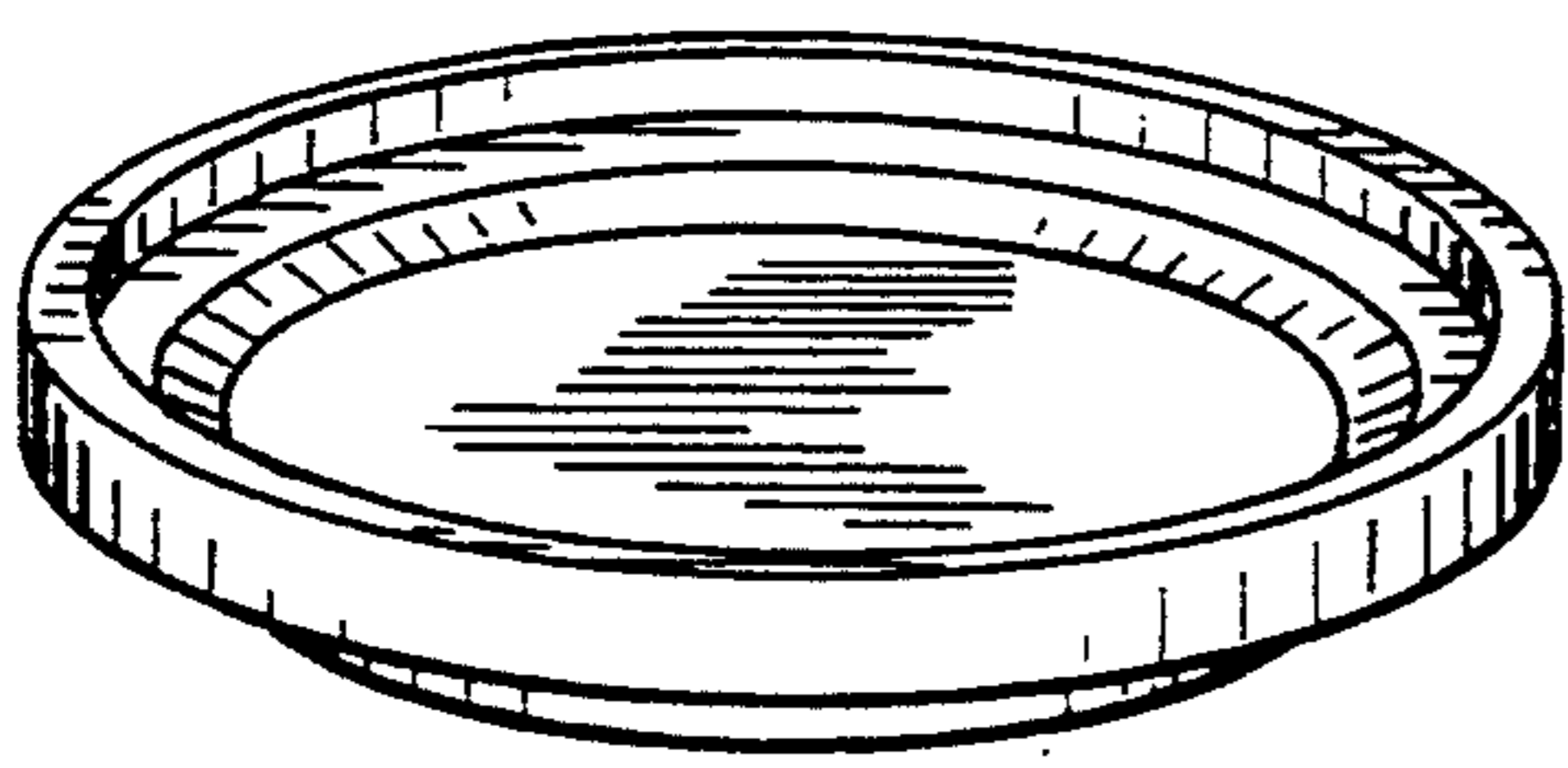

FIG. 1

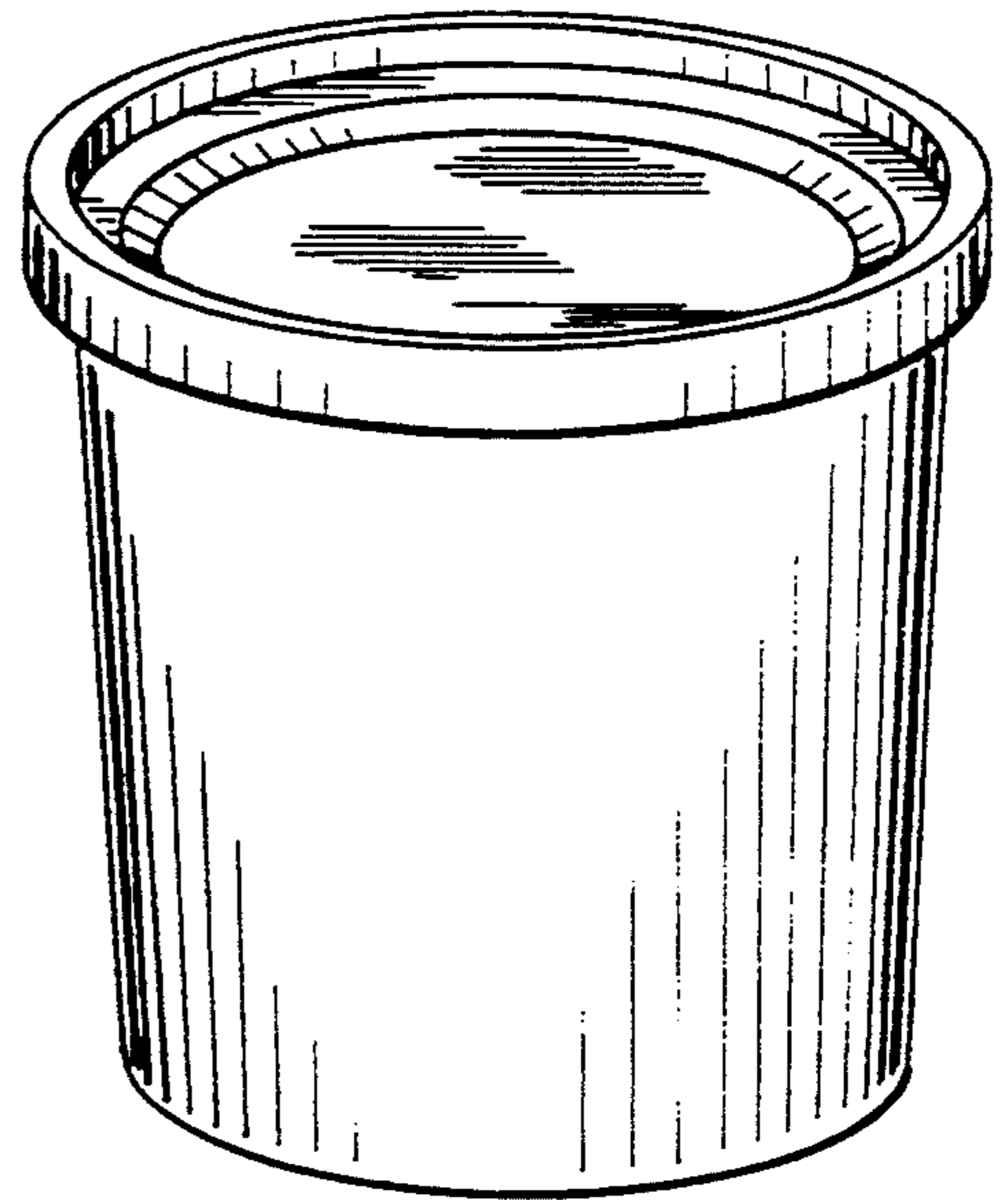

FIG. 2

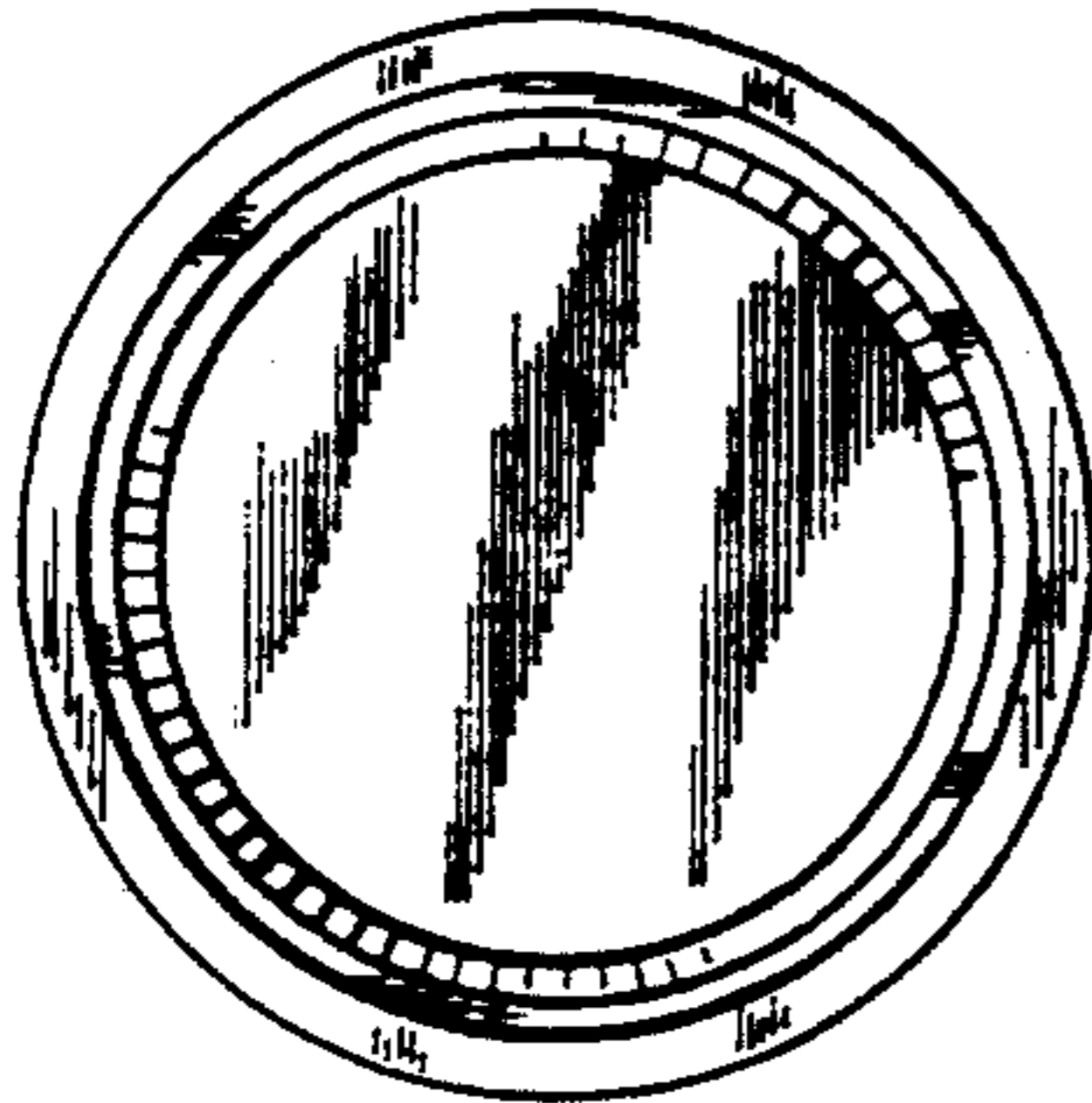

FIG. 3

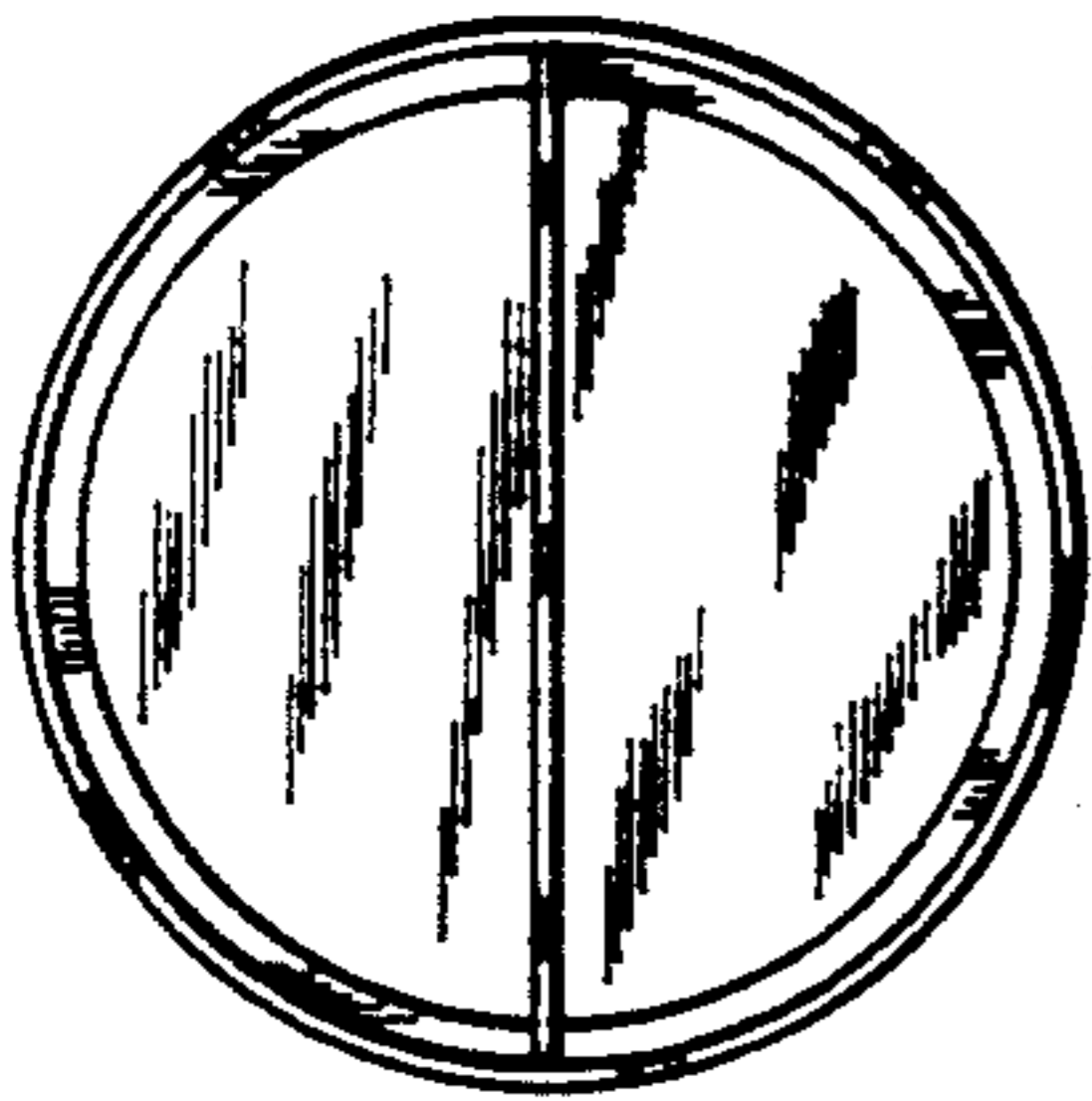

FIG. 6

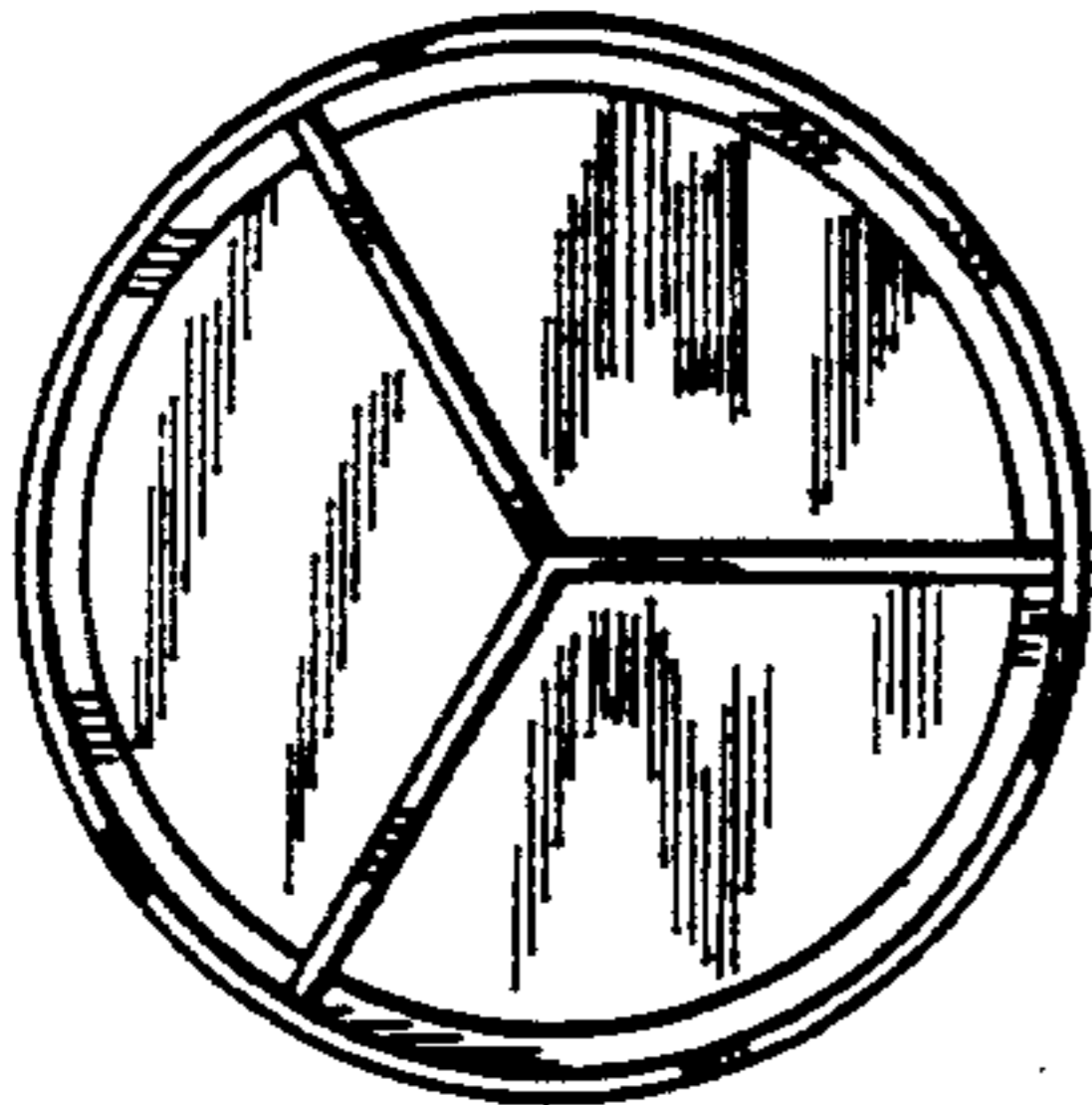

FIG. 9

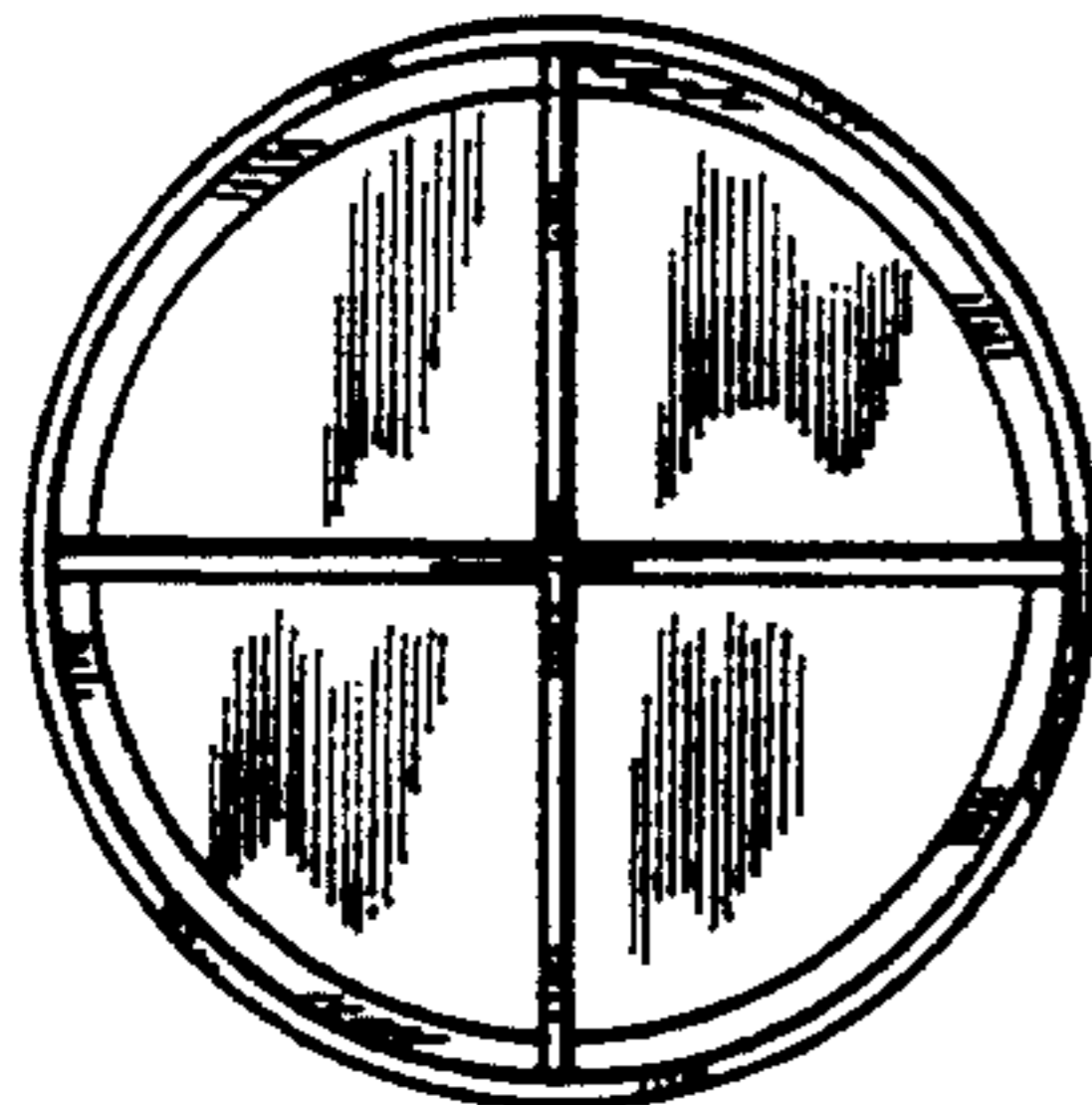

FIG. 12

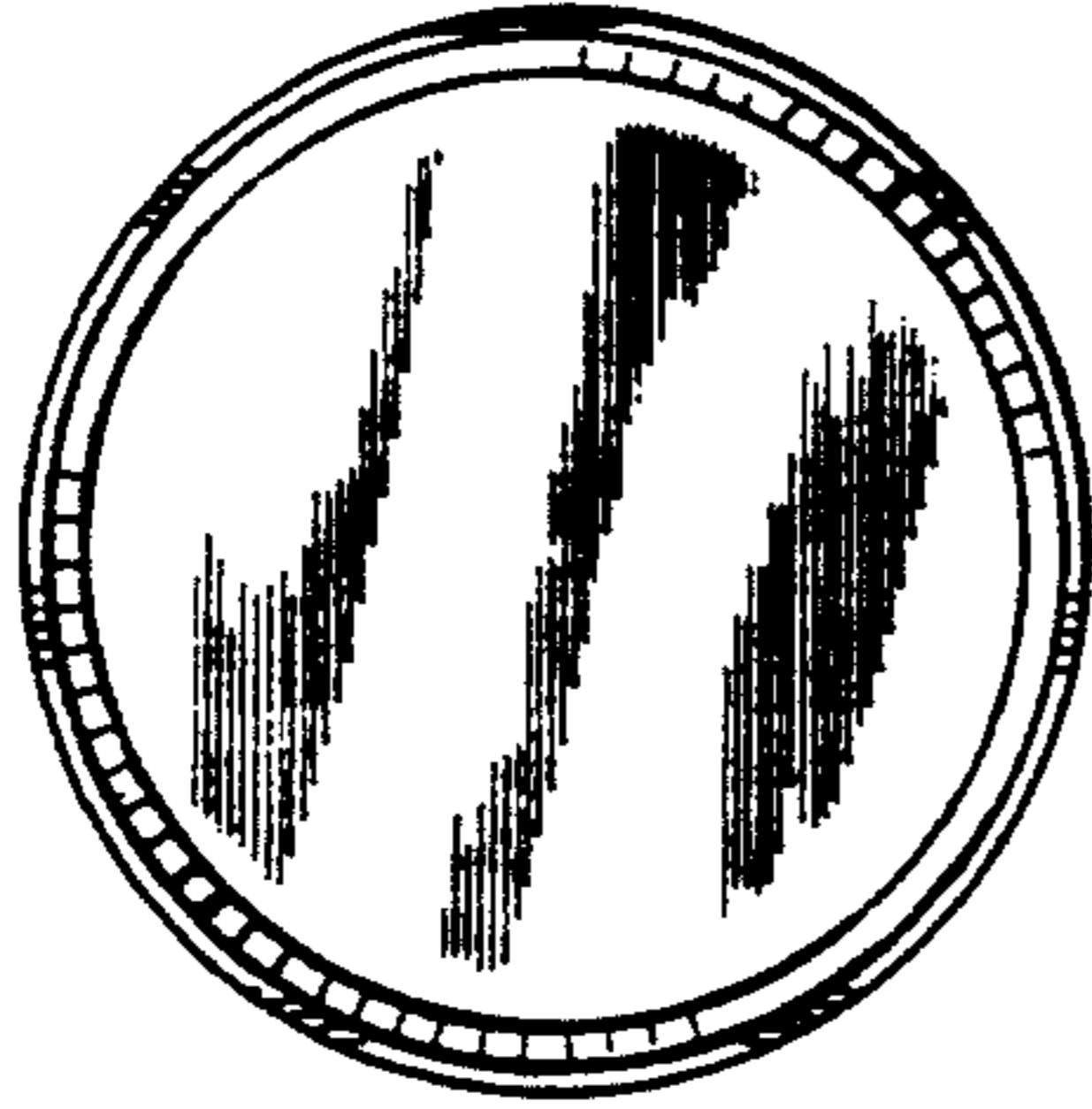

FIG. 15

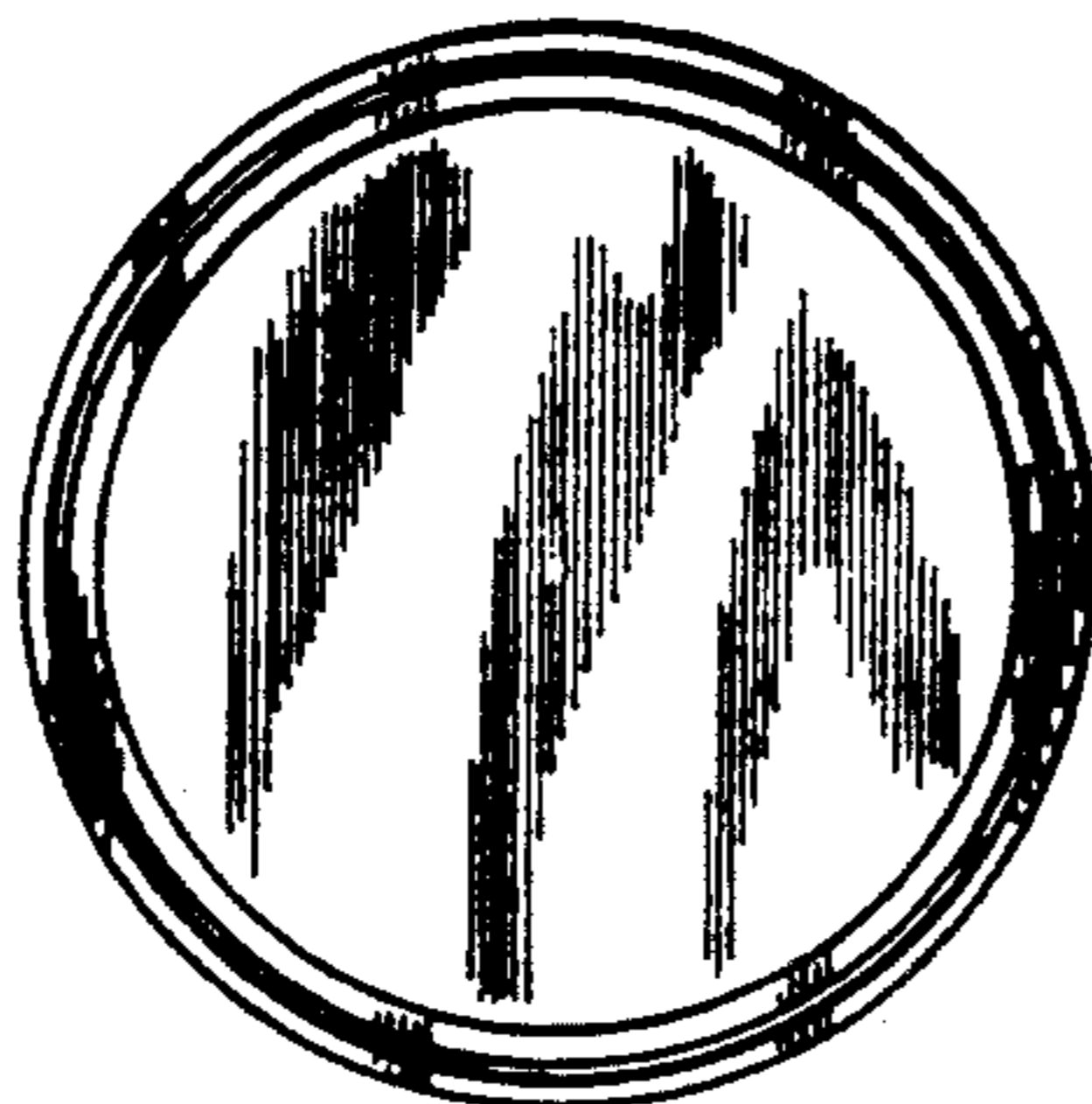

FIG. 4

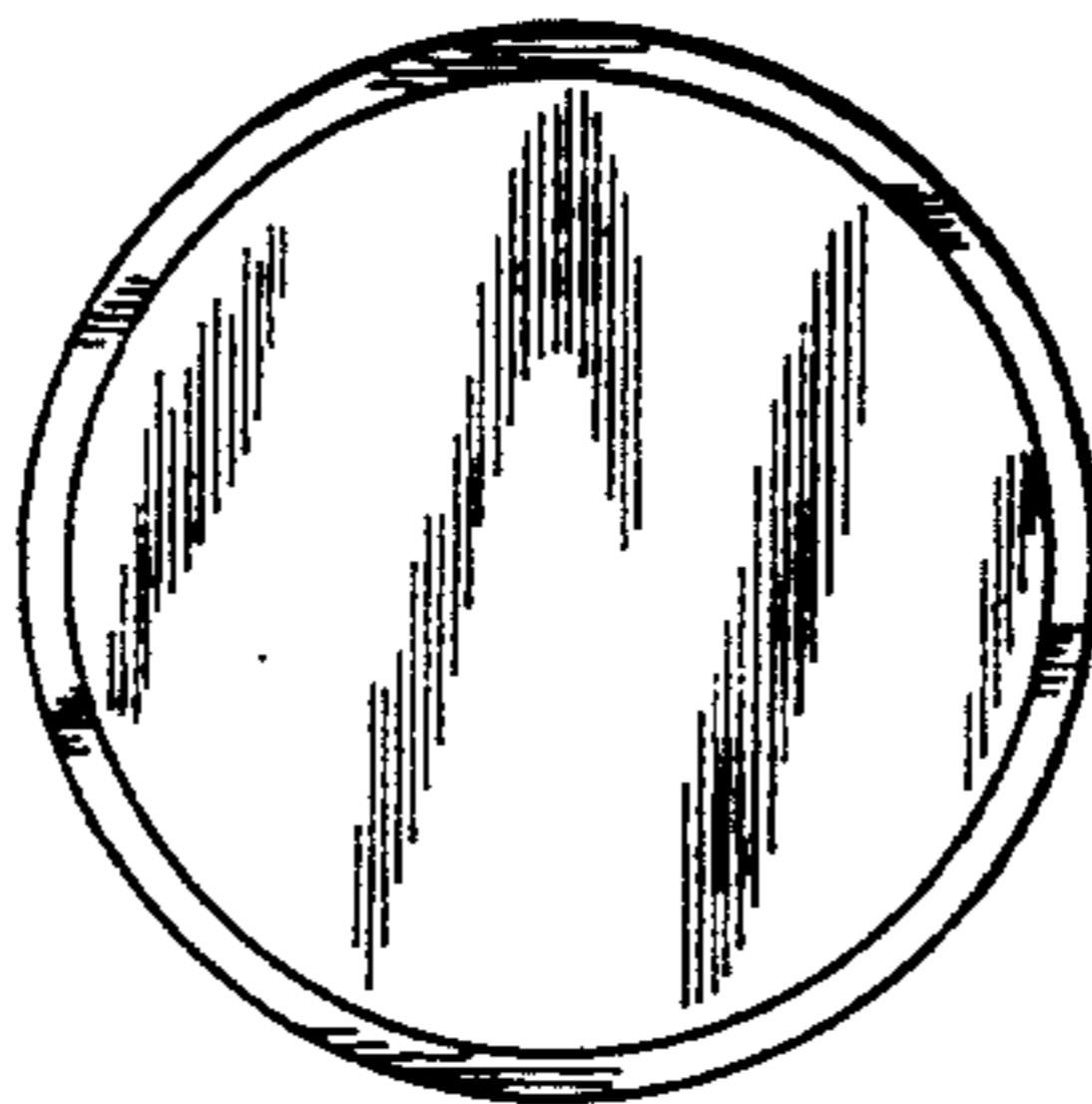

FIG. 7

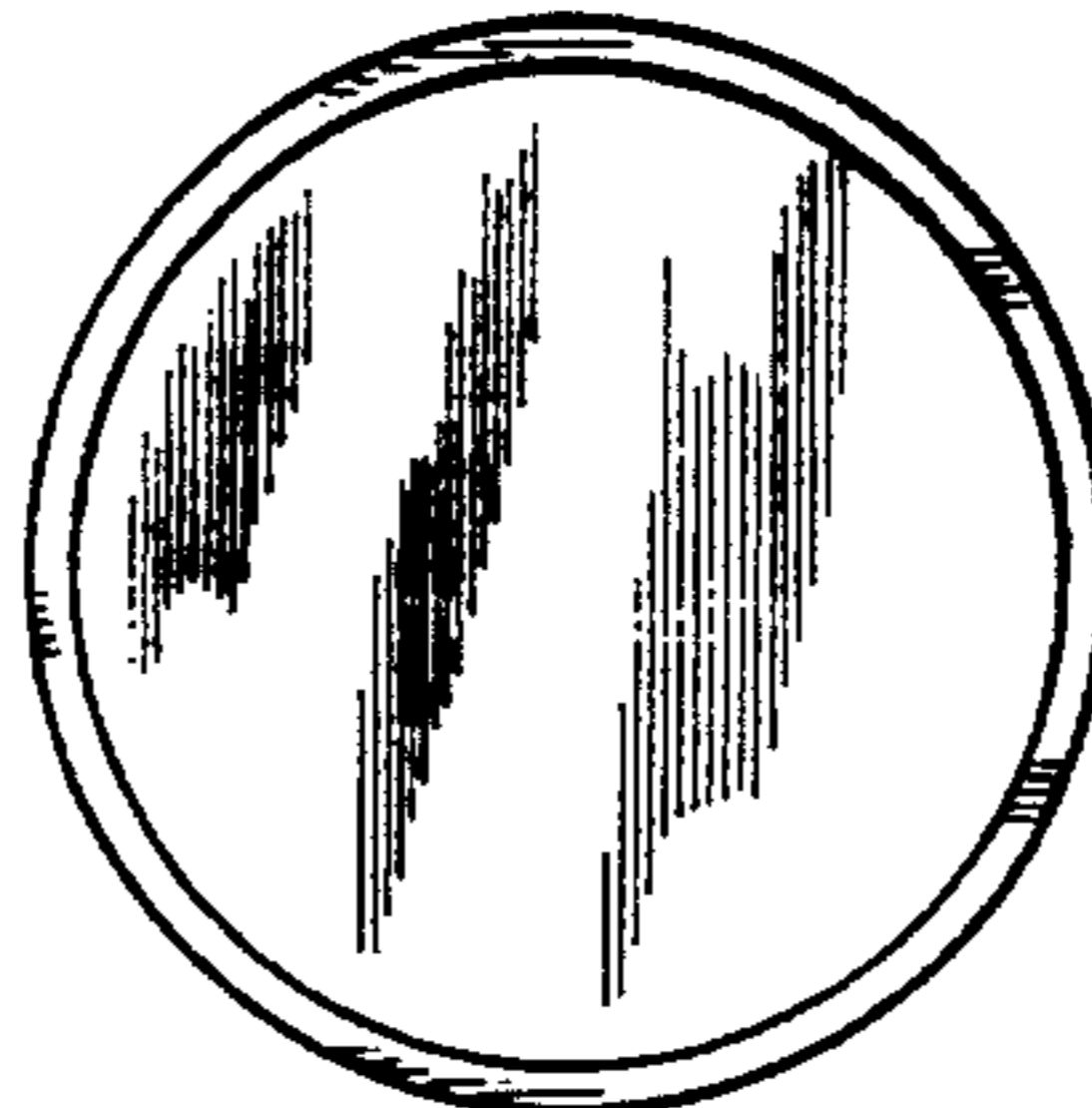

FIG. 10

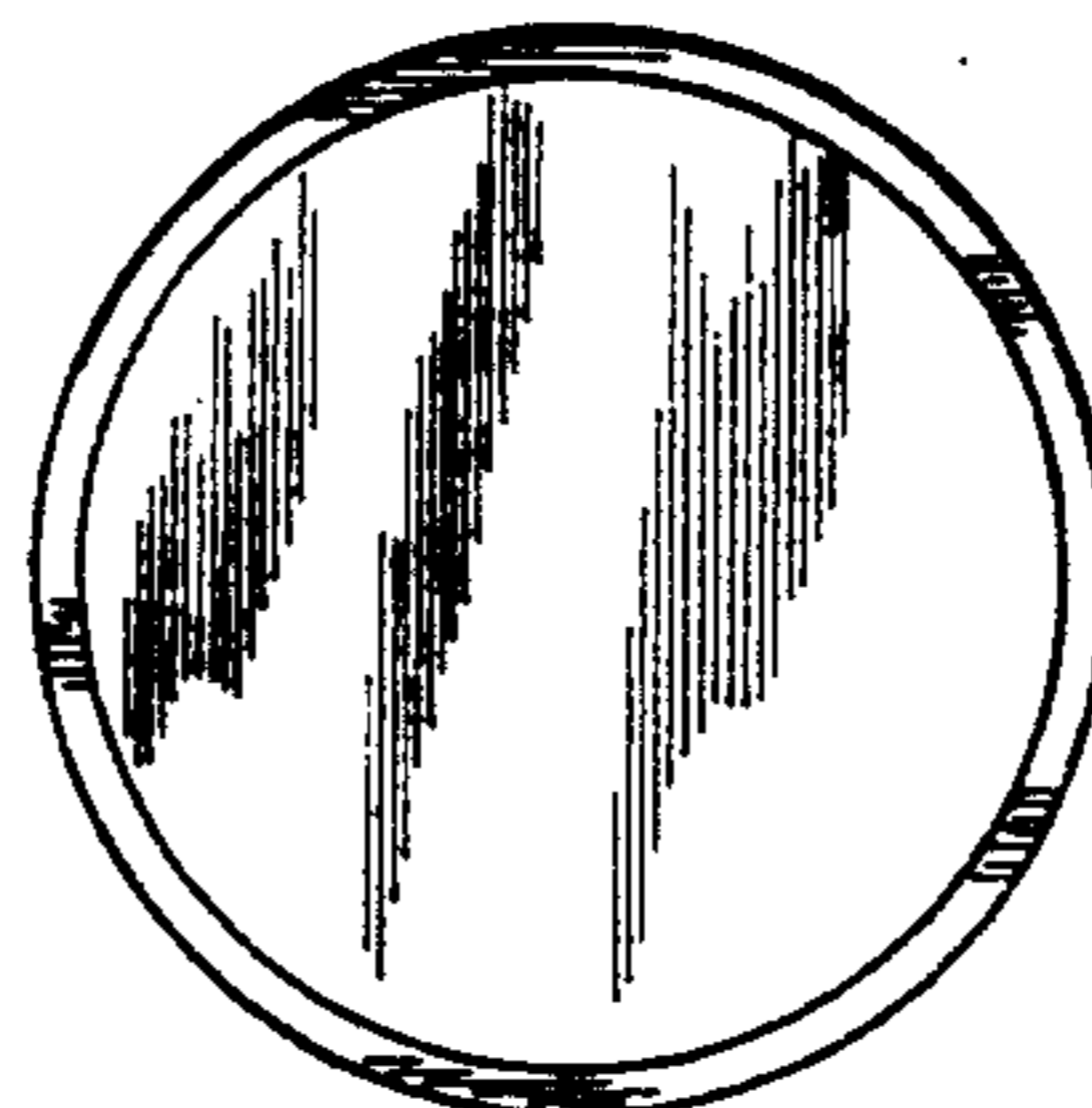

FIG. 13

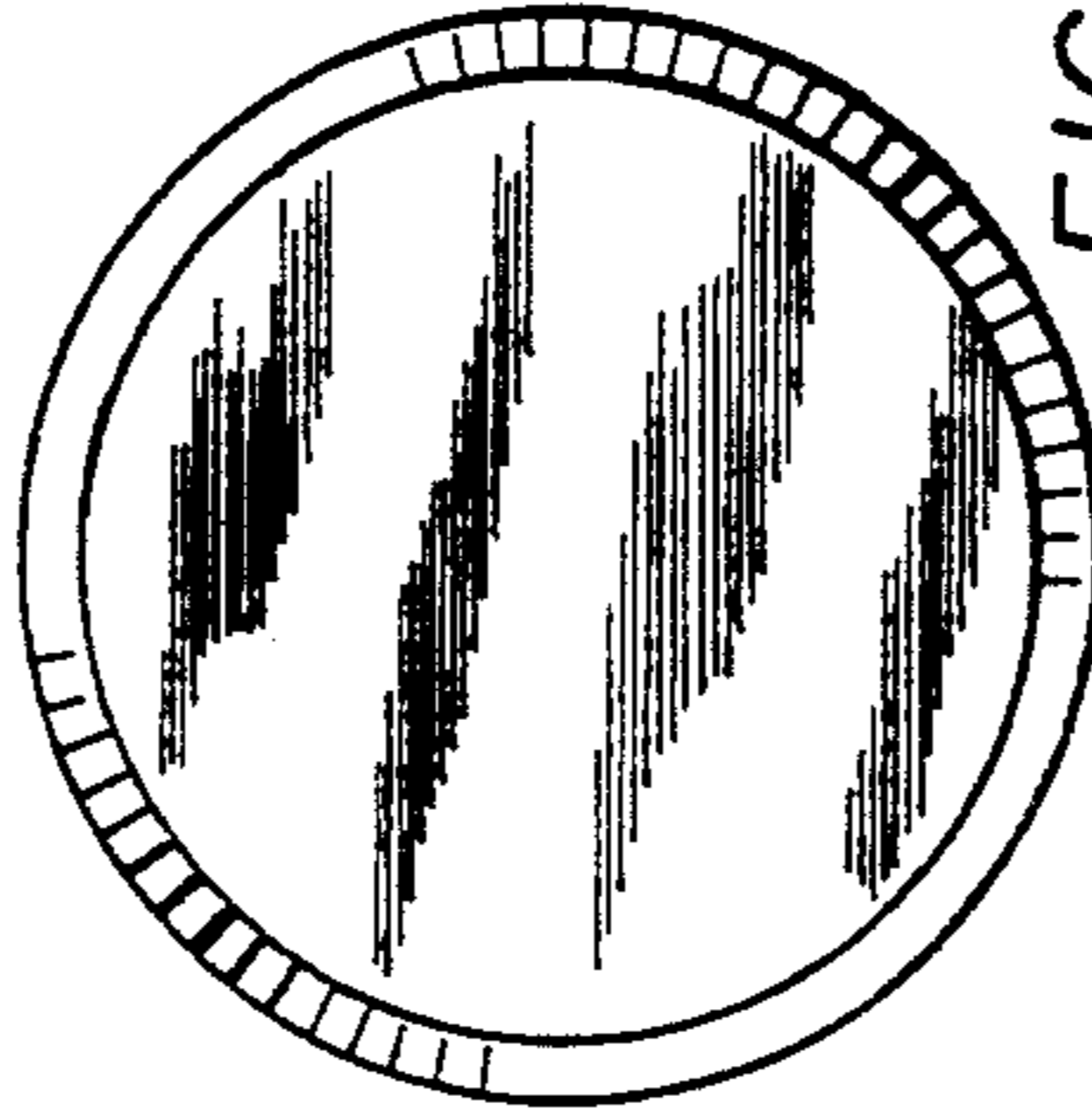

FIG. 16



FIG. 5



FIG. 8

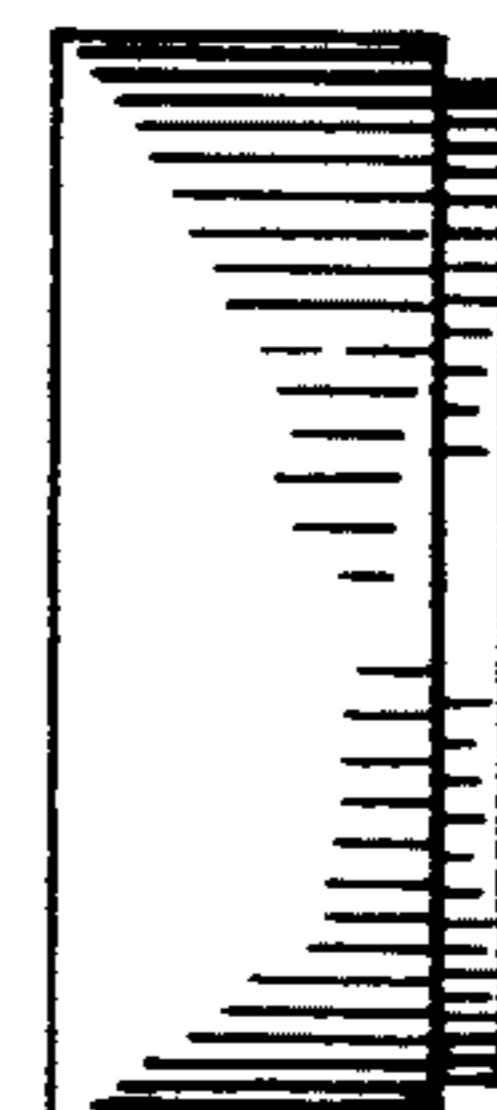

FIG. 11

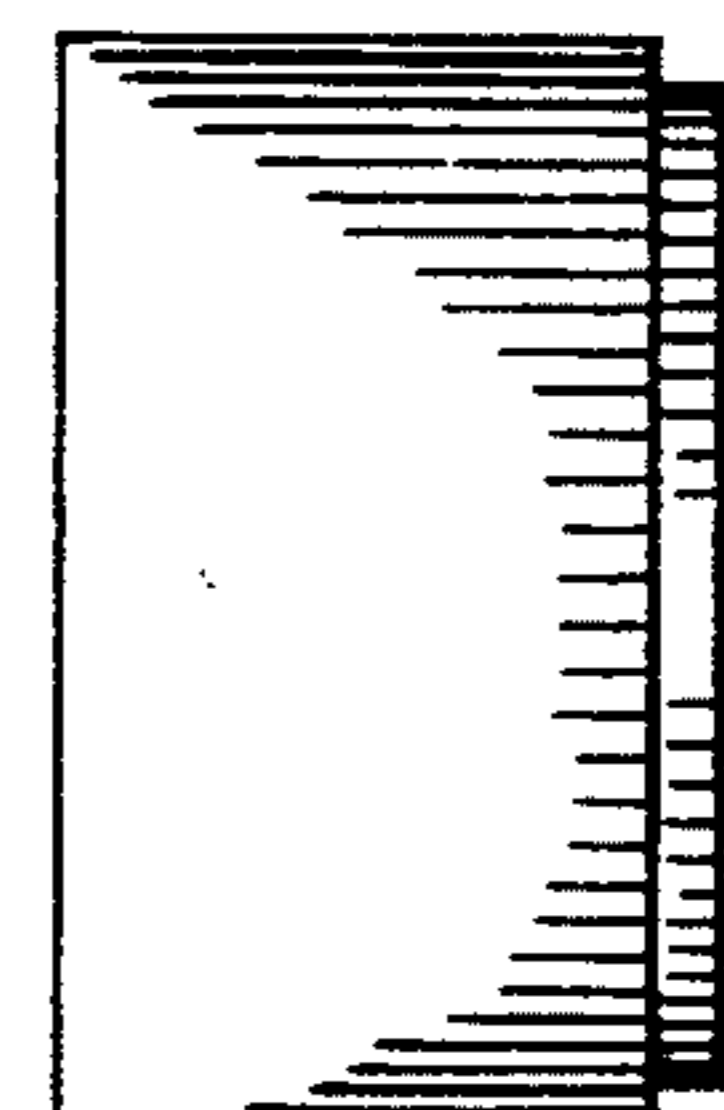

FIG. 14

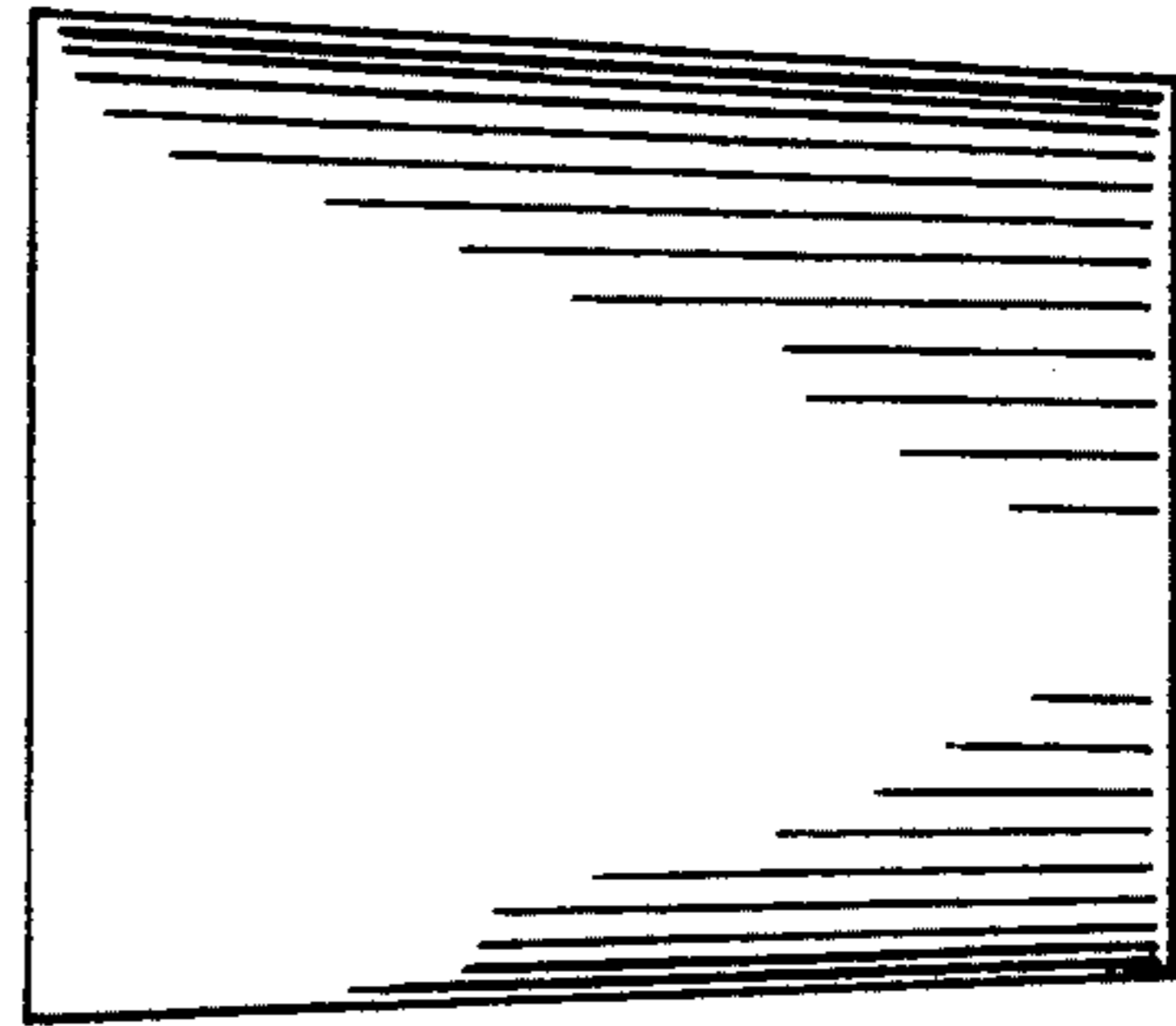

FIG. 17