



US00D355665S

# United States Patent [19]

[11] Patent Number: **Des. 355,665**

Omi

[45] Date of Patent: **\*\* Feb. 21, 1995**

[54] CAMERA SUPPORT FOR ATTACHMENT TO A MICROSCOPE

[75] Inventor: **Shoichi Omi**, Tokyo, Japan

[73] Assignee: **Lunax Company Limited**, Ibaraki, Japan

[\*\*] Term: **14 Years**

[21] Appl. No.: **16,108**

[22] Filed: **Dec. 7, 1993**

[30] **Foreign Application Priority Data**

Jun. 7, 1993 [JP] Japan ..... 5-16943

[52] U.S. Cl. .... **D16/242; D16/237**

[58] Field of Search ..... **D3/219, 267, 268; D16/131, 136, 237, 242; 224/229; 248/179; 354/293, 81, 79**

[56] **References Cited**

**U.S. PATENT DOCUMENTS**

D. 203,705	2/1966	Armbruster .....	D16/131
D. 209,635	12/1967	Korte .....	D16/242
D. 283,821	5/1986	Lemmey .....	D16/242
D. 310,677	9/1990	Stidham, Jr. et al. ....	D16/242
D. 313,030	12/1990	Morton .....	D16/242
D. 344,967	3/1994	Webster .....	D16/136
2,624,252	1/1953	Judd .....	D16/242
2,922,609	1/1960	Collier .....	248/179
2,933,992	4/1960	Bushnell et al. ....	354/293
2,967,456	1/1961	Maier .....	354/79
3,798,665	3/1974	Eloranta et al. ....	D16/131
4,341,331	7/1982	McDougall .....	224/229
4,637,535	1/1987	Aleman .....	D16/242

*Primary Examiner*—C. A. Murphy  
*Attorney, Agent, or Firm*—Popham Haik Schnobrich & Kaufman, Ltd.

[57] **CLAIM**

The ornamental design for a camera support for attachment to a microscope, as shown and described.

**DESCRIPTION**

FIG. 1 is a perspective view of a camera support for attachment to a showing my new microscope design, taken from a front, right and upper position thereof; FIG. 2 is a front elevational view thereof, the rear being identical;

FIG. 3 is a top plan view thereof;

FIG. 4 is a bottom plan view thereof;

FIG. 5 is a right side elevational view thereof;

FIG. 6 is a right side elevational view thereof, the tape being extended;

FIG. 7 is a top plan view thereof, the tape being extended;

FIG. 8 is a cross sectional view taken on line 8—8 of FIG. 2;

FIG. 9 is a cross sectional view taken on line 9—9 of FIG. 6;

FIG. 10 is a perspective view thereof shown in use, the broken lines showing a camera in FIG. 10 being for illustrative purposes only and forming no part of the claimed design; and,

FIG. 11 is a perspective view thereof in use, the broken lines showing a camera and a combined projector and microscope being for illustrative purposes only and forming no part of the claimed design.

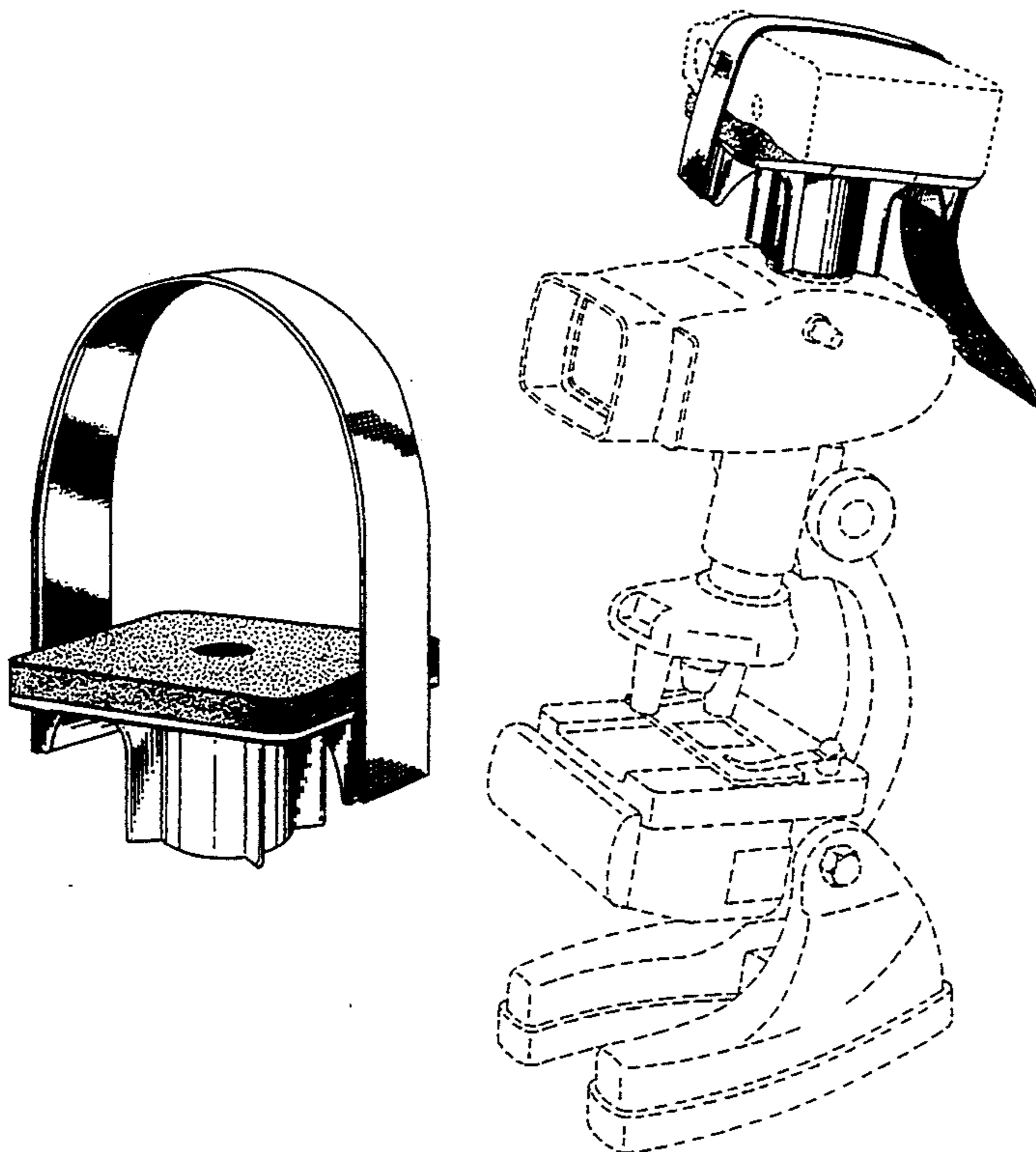

FIG. 1

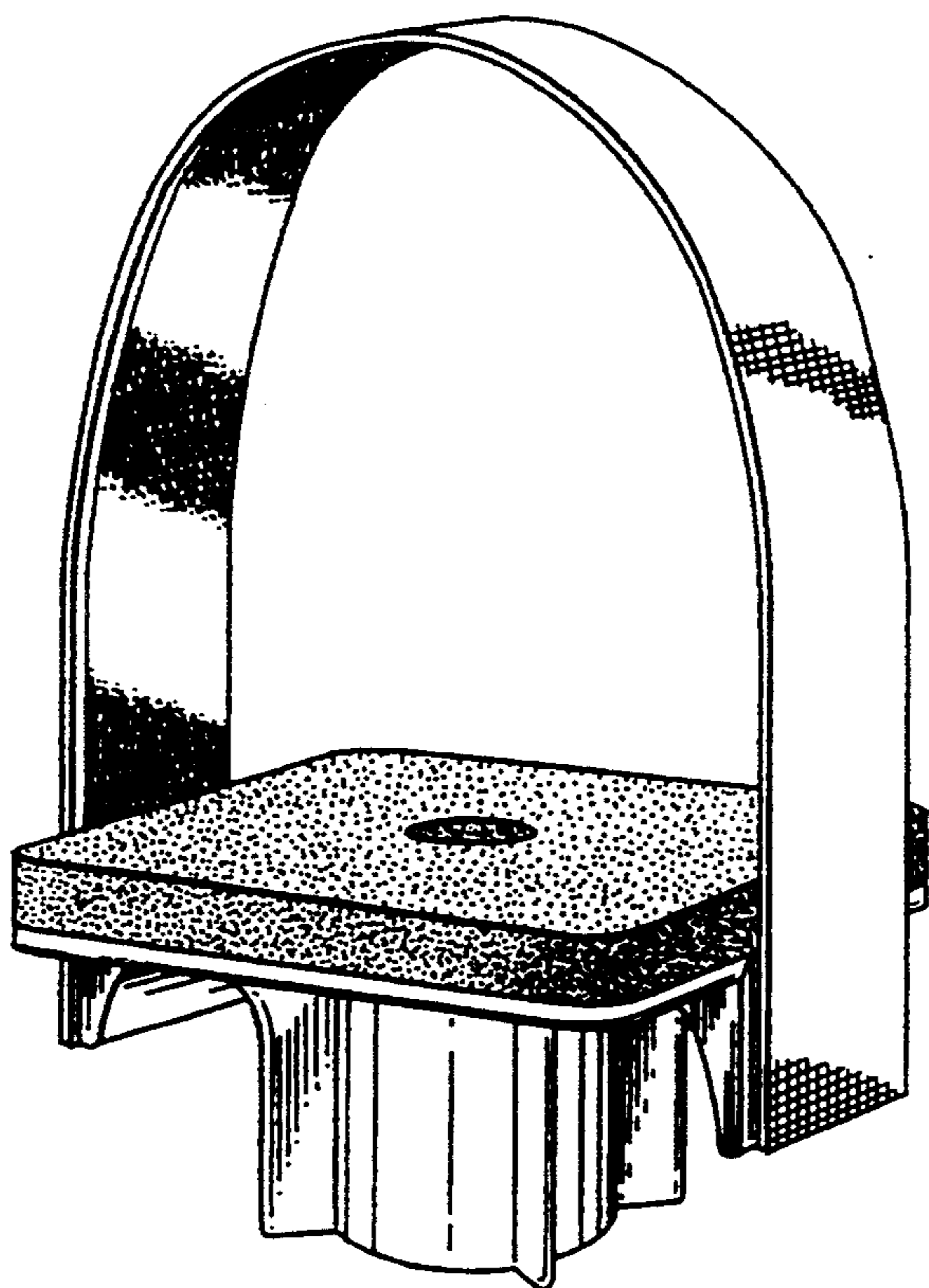

FIG. 2

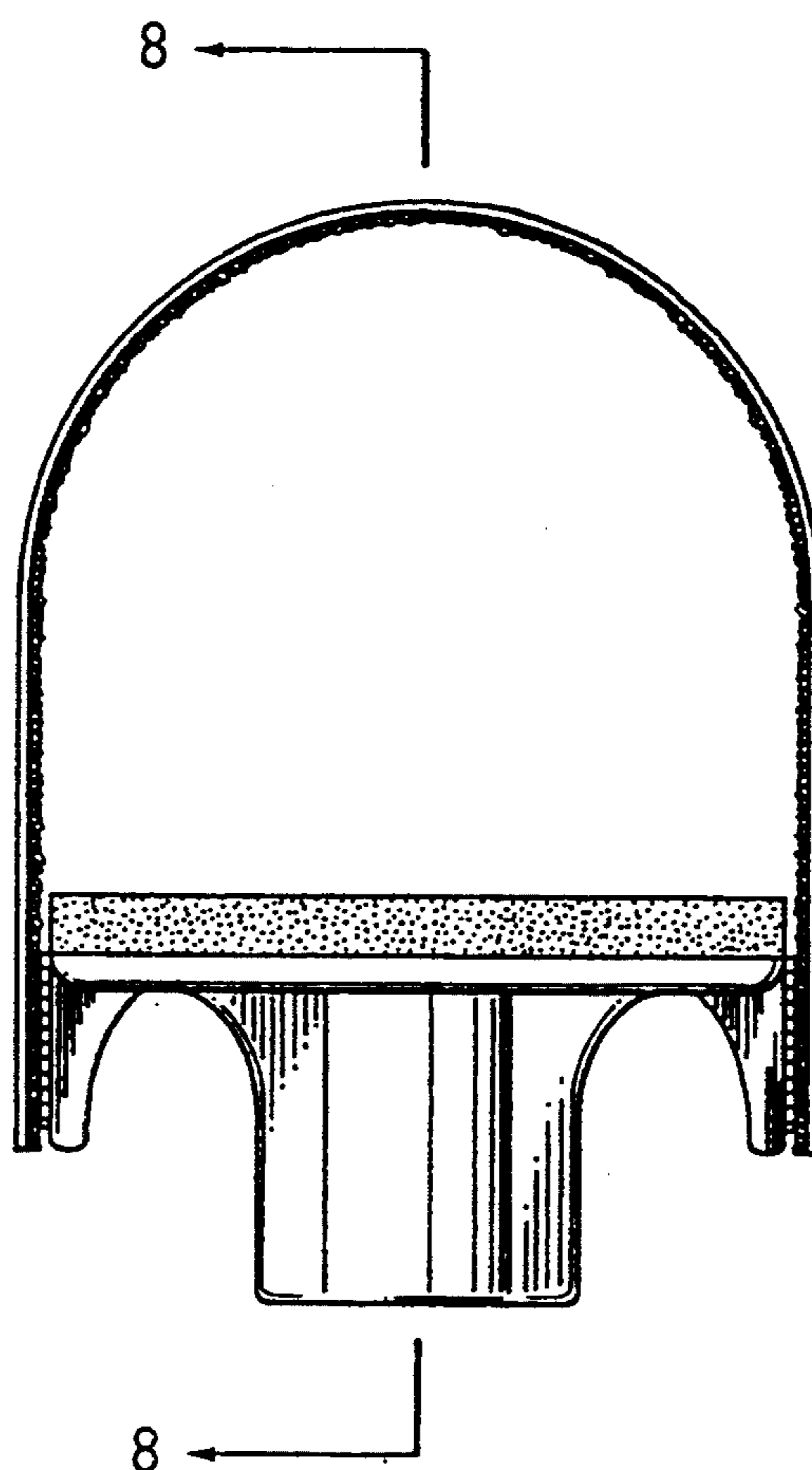

FIG. 3

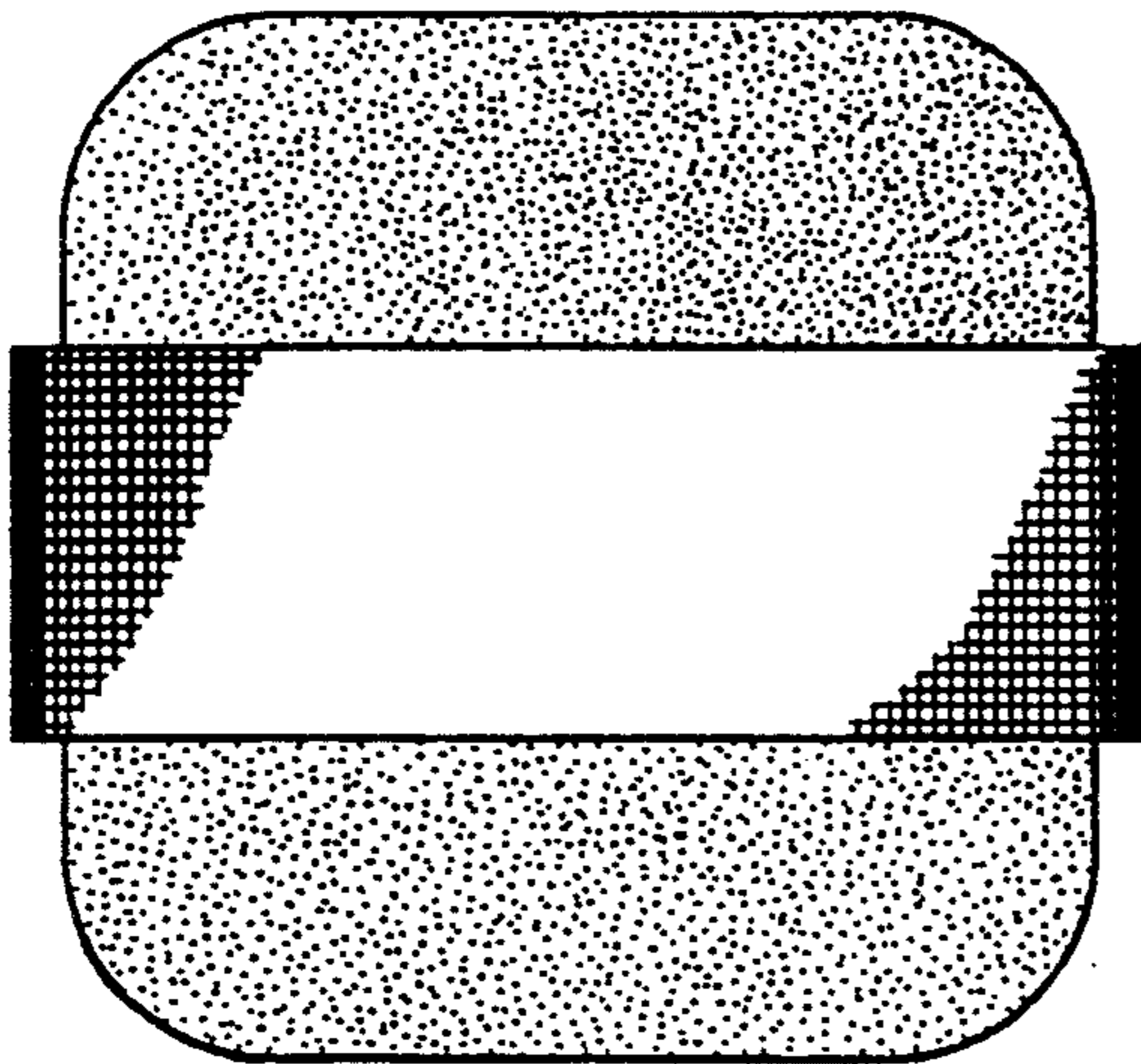

FIG. 4

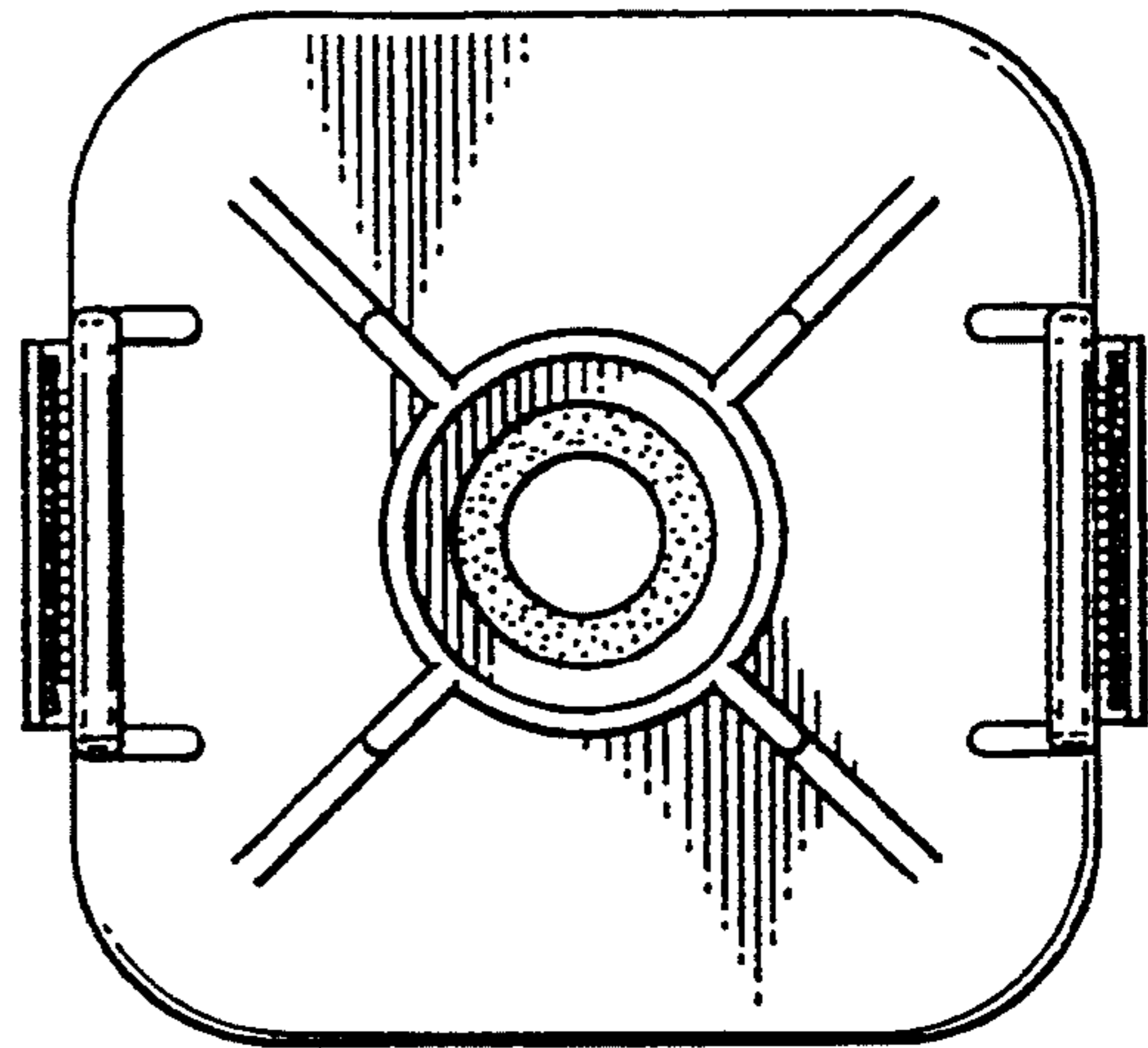

FIG. 5

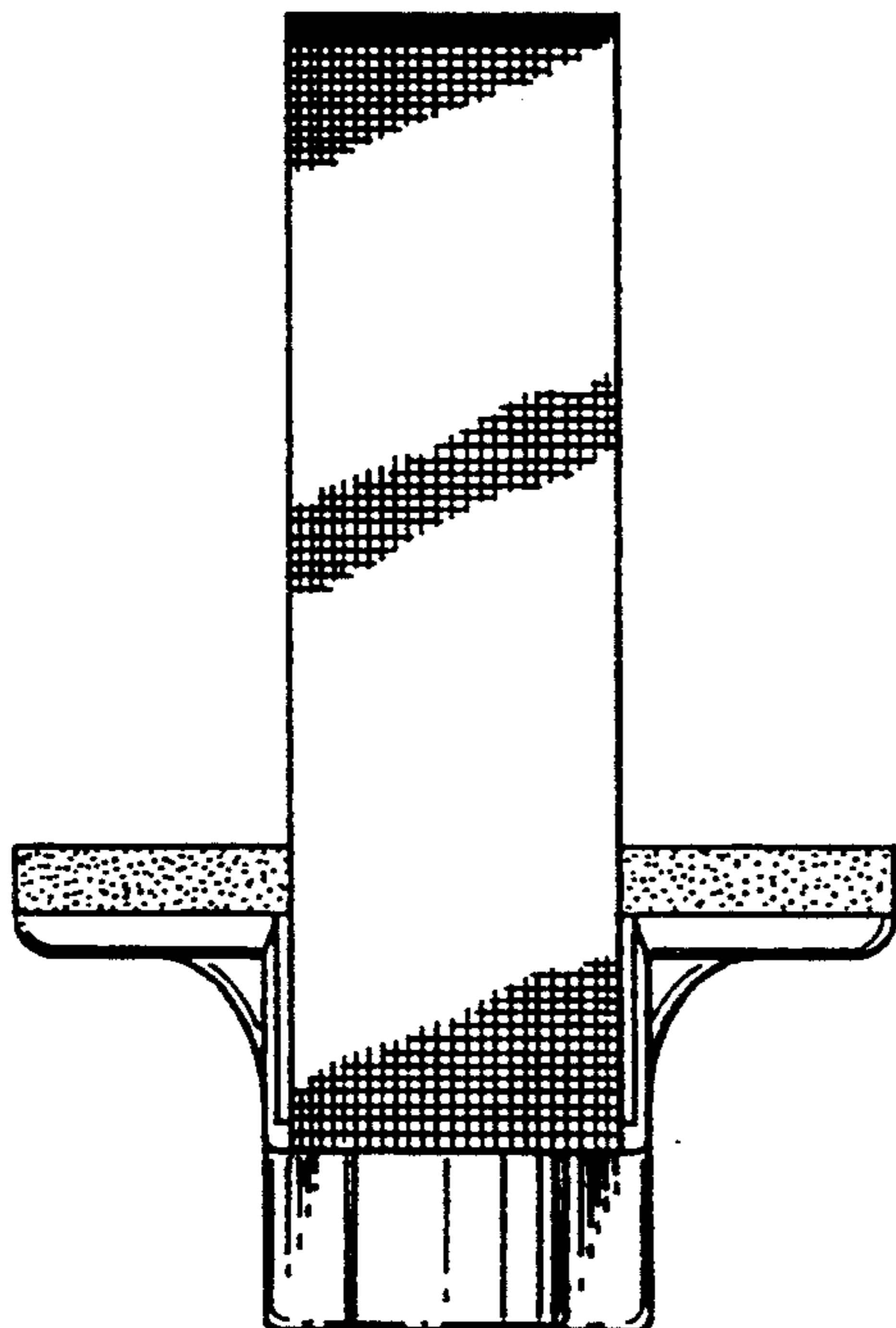

FIG. 8

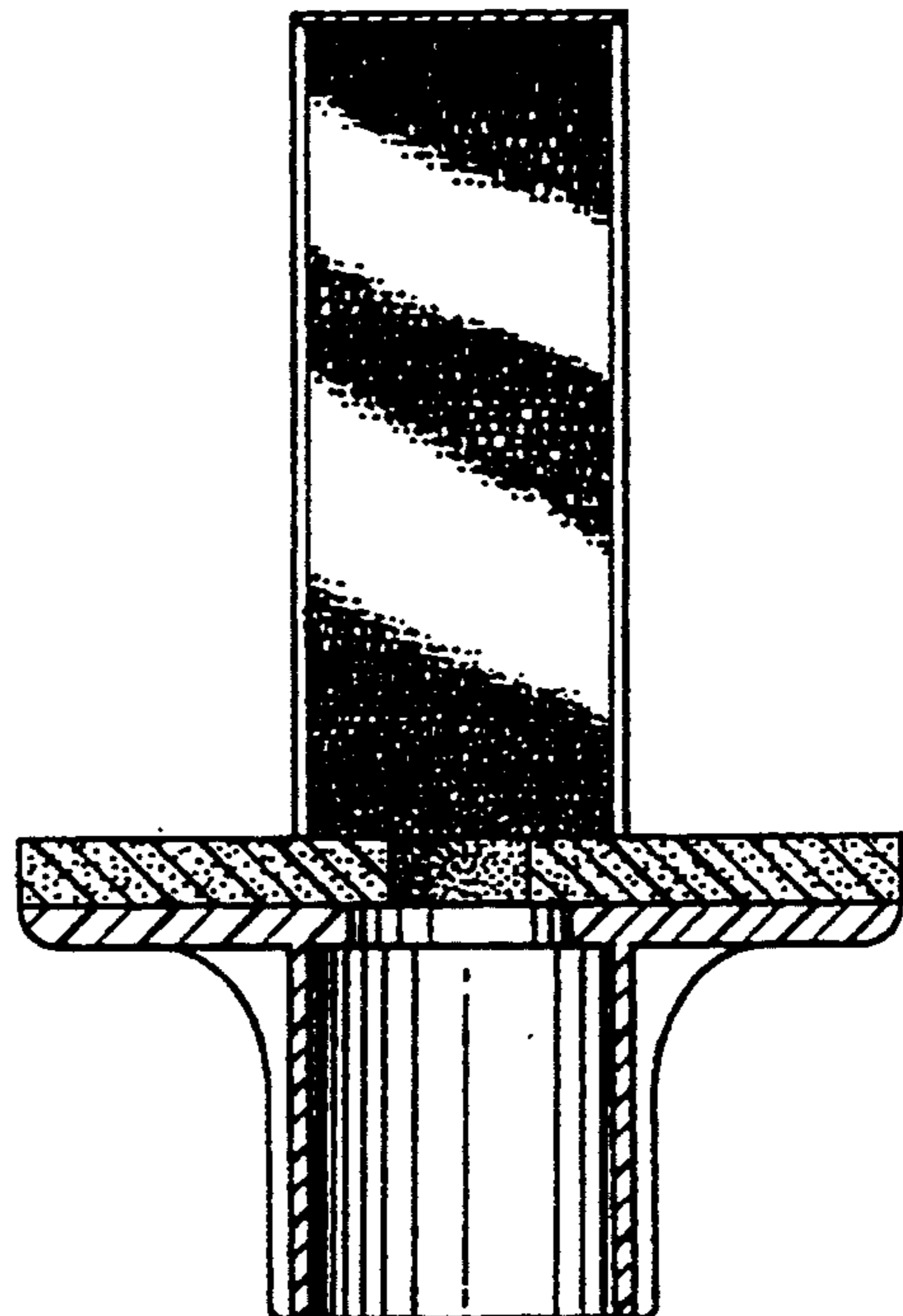

FIG. 6

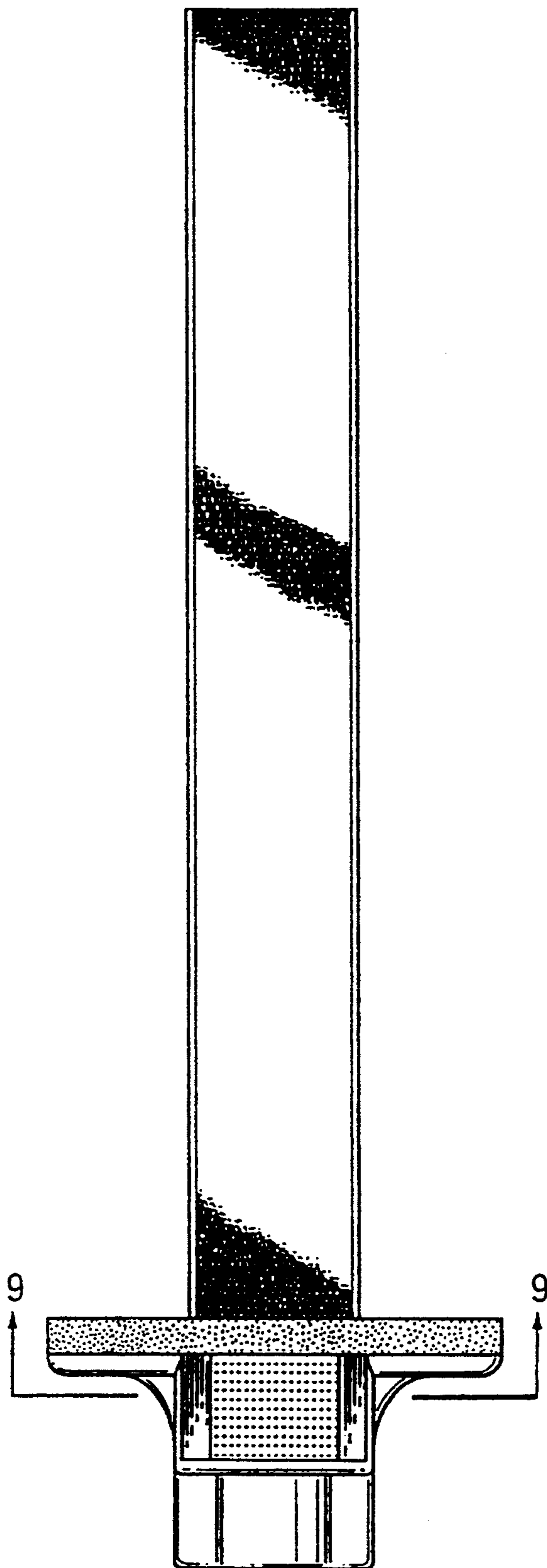

FIG. 7

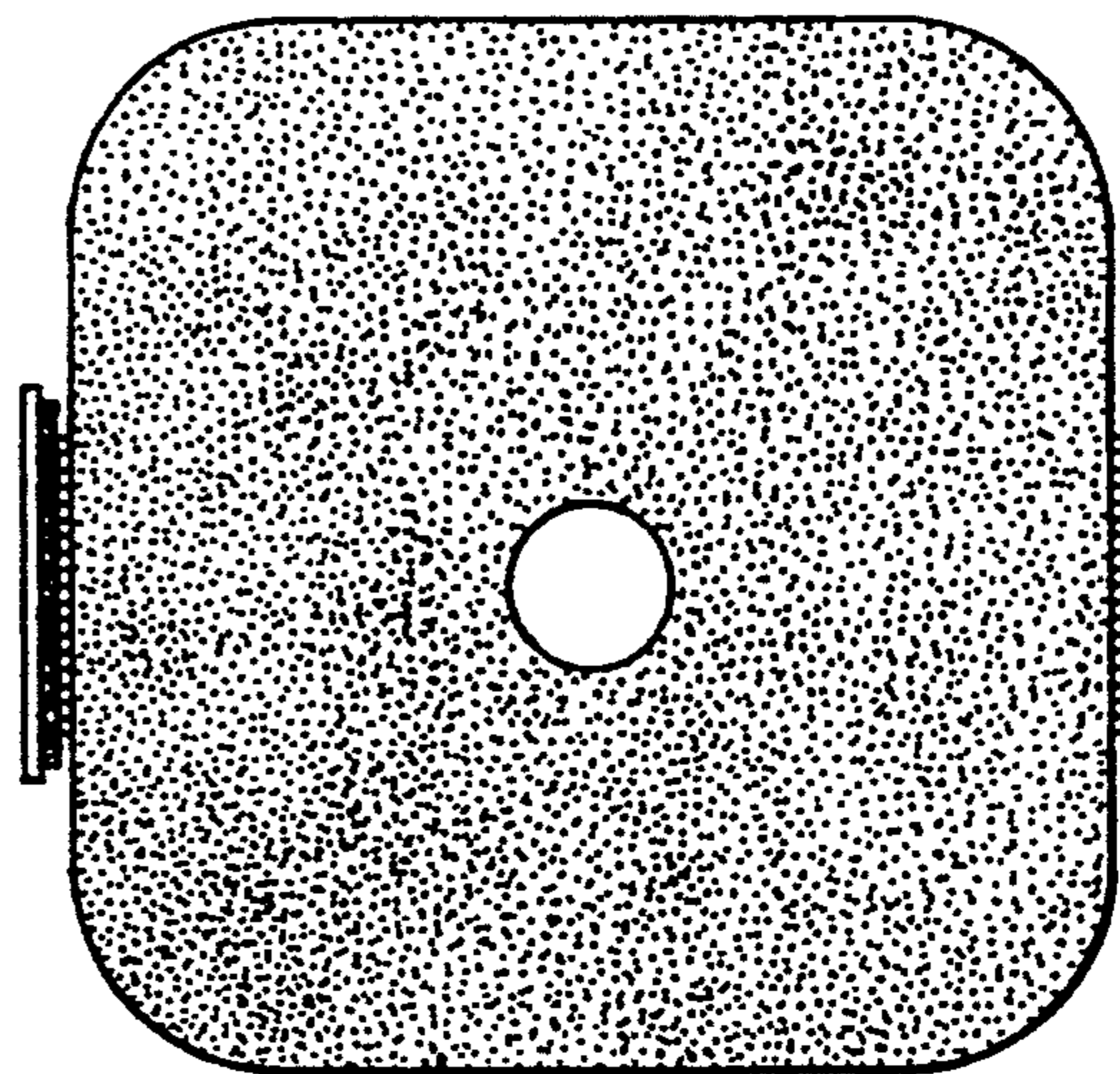

FIG. 9

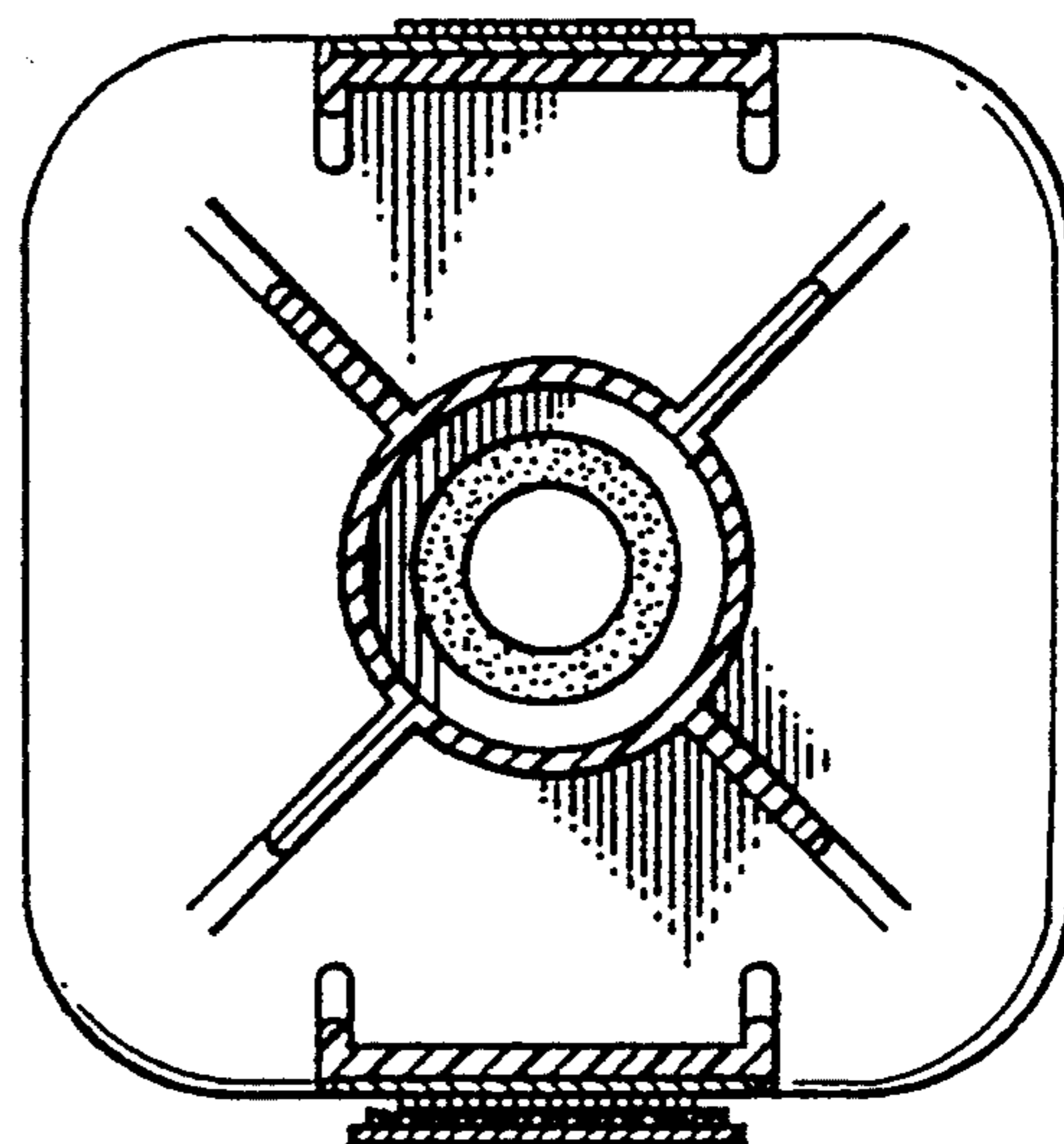

FIG. 10

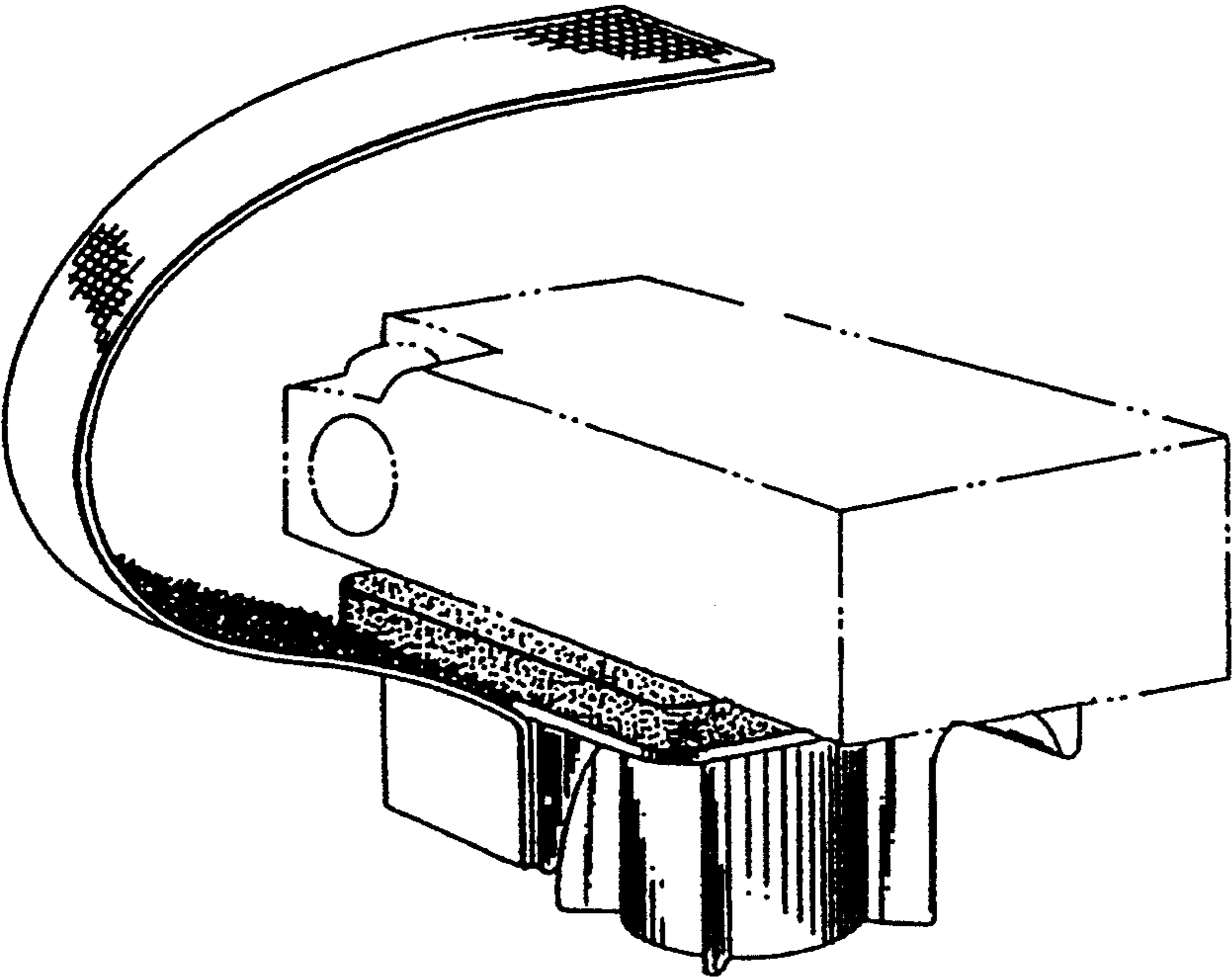

FIG. 11

