



US00D355644S

United States Patent [19] Risko

[11] Patent Number: **Des. 355,644**

[45] Date of Patent: **** Feb. 21, 1995**

[54] **ELECTRONIC DEVICE ENCLOSURE**

[75] Inventor: **John J. Risko**, Stayton, Oreg.

[73] Assignee: **II Morrow Inc.**, Salem, Oreg.

[**] Term: **14 Years**

[21] Appl. No.: **10,996**

[22] Filed: **Jul. 22, 1993**

[52] U.S. Cl. **D14/100; D21/13**

[58] Field of Search **D14/100, 105, 106, 107; D18/1, 7, 11, 12, 4; D21/13, 38; 345/156, 168, 169, 172, 173; 364/708.1**

[56] **References Cited**

U.S. PATENT DOCUMENTS

- D. 262,122 12/1981 Lovejoy D21/13
- D. 263,157 2/1982 Takagi D21/13
- D. 345,548 3/1994 Giebler et al. D14/100

Primary Examiner—Freda S. Nunn

Attorney, Agent, or Firm—William A. Birdwell & Associates

[57] **CLAIM**

The ornamental design for a electronic device enclosure, as shown and described.

DESCRIPTION

FIG. 1 is a reduced top front and right side perspective view of an electronic device enclosure showing my new design;

FIG. 2 is a top plan view of the electronic device enclosure of FIG. 1;

FIG. 3 is a right side view in elevation of the electronic device enclosure the left side view is identical in appearance;

FIG. 4 is a bottom plan view of the electronic device enclosure of FIG. 1;

FIG. 5 is a front view in elevation of the electronic device enclosure of FIG. 1; and,

FIG. 6 is a rear view in elevation of the electronic device enclosure.

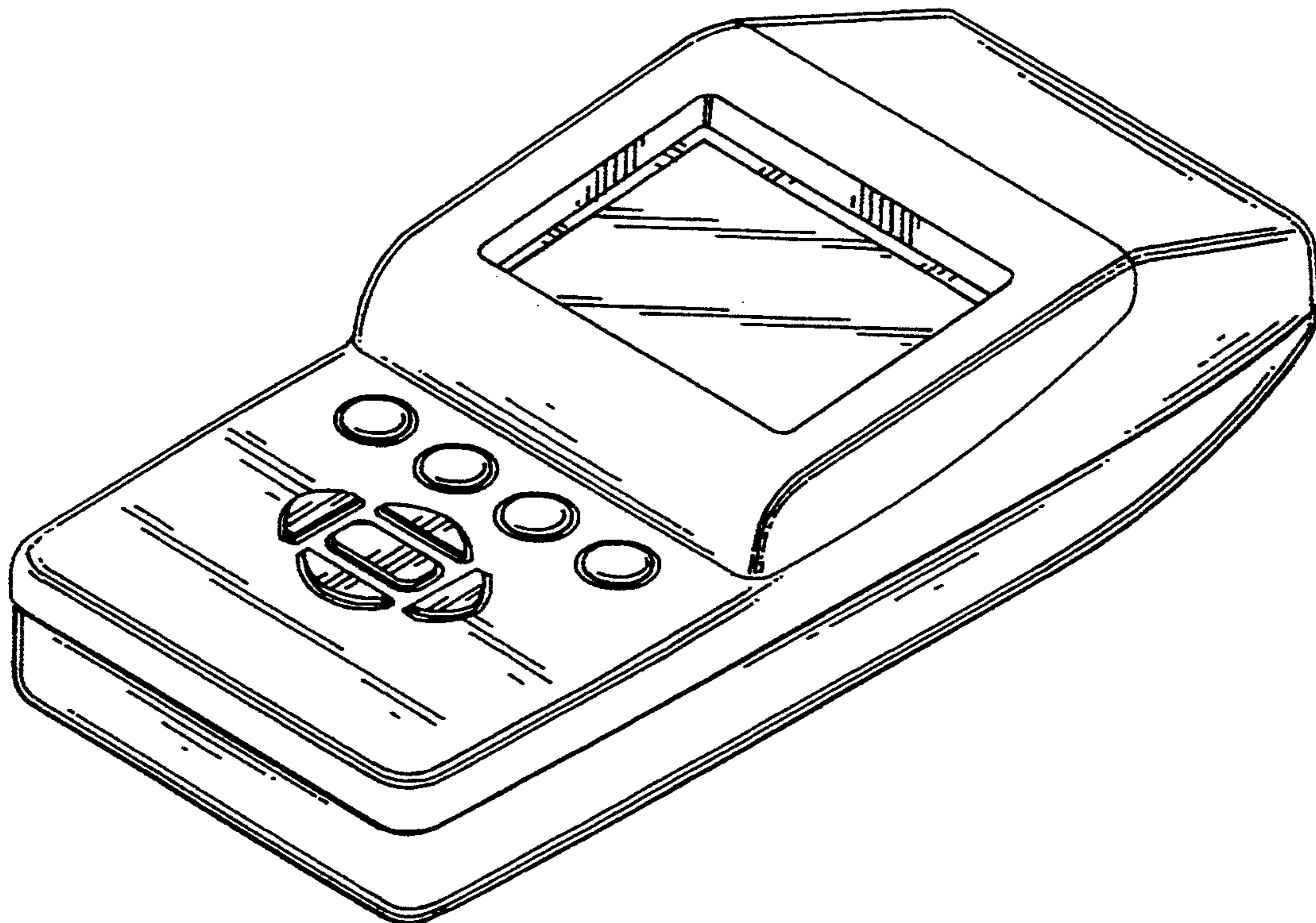

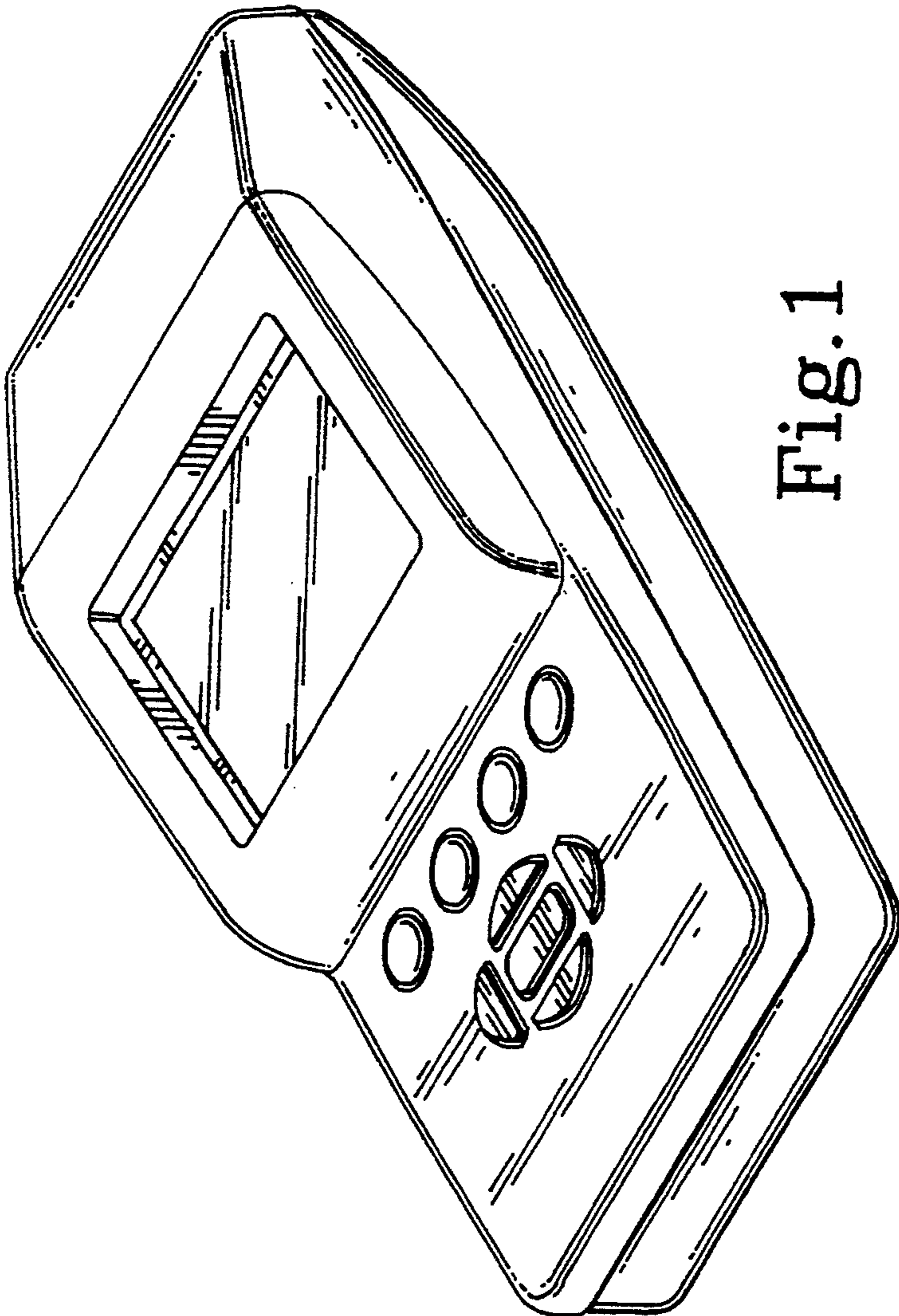

Fig. 1

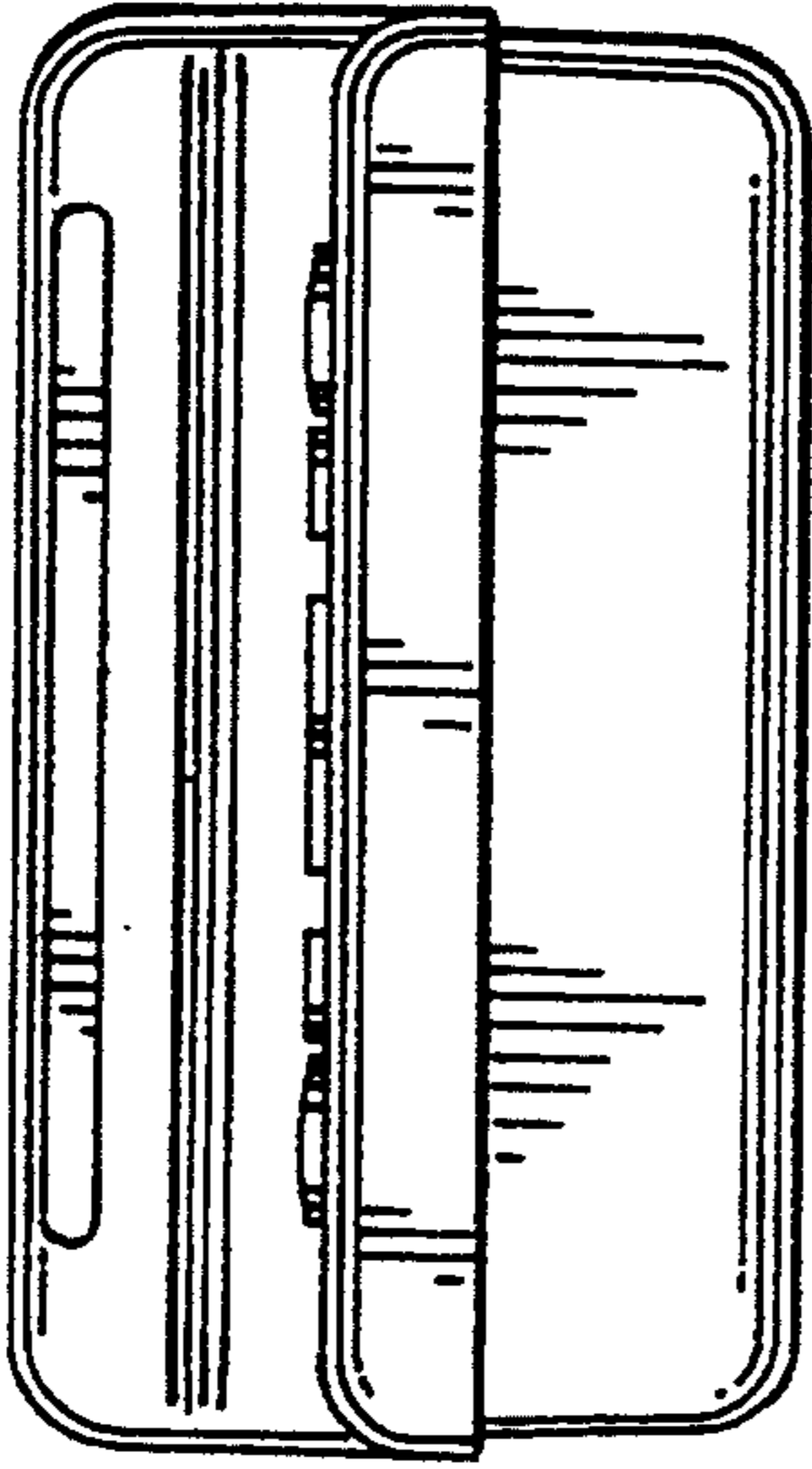

Fig. 5

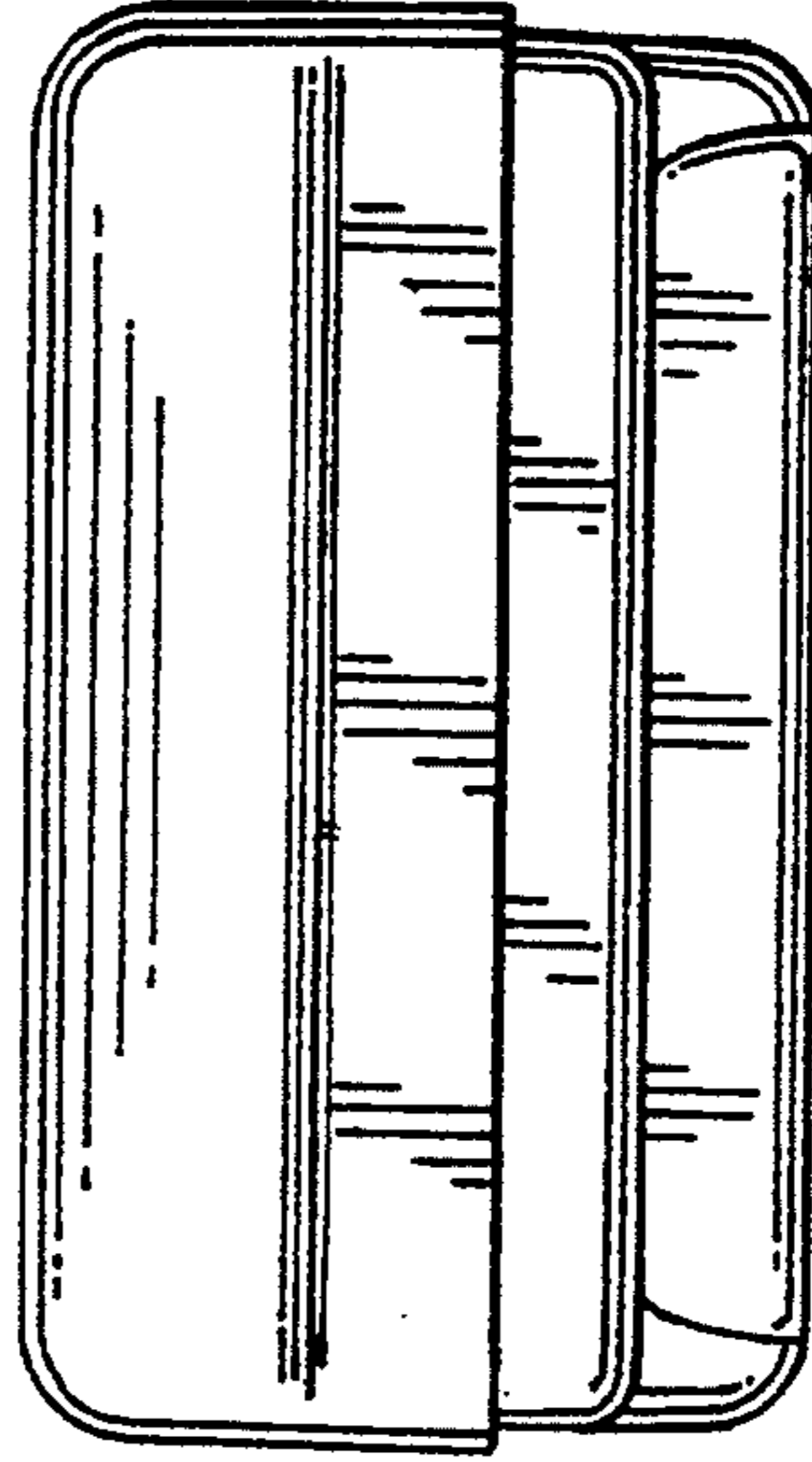

Fig. 6

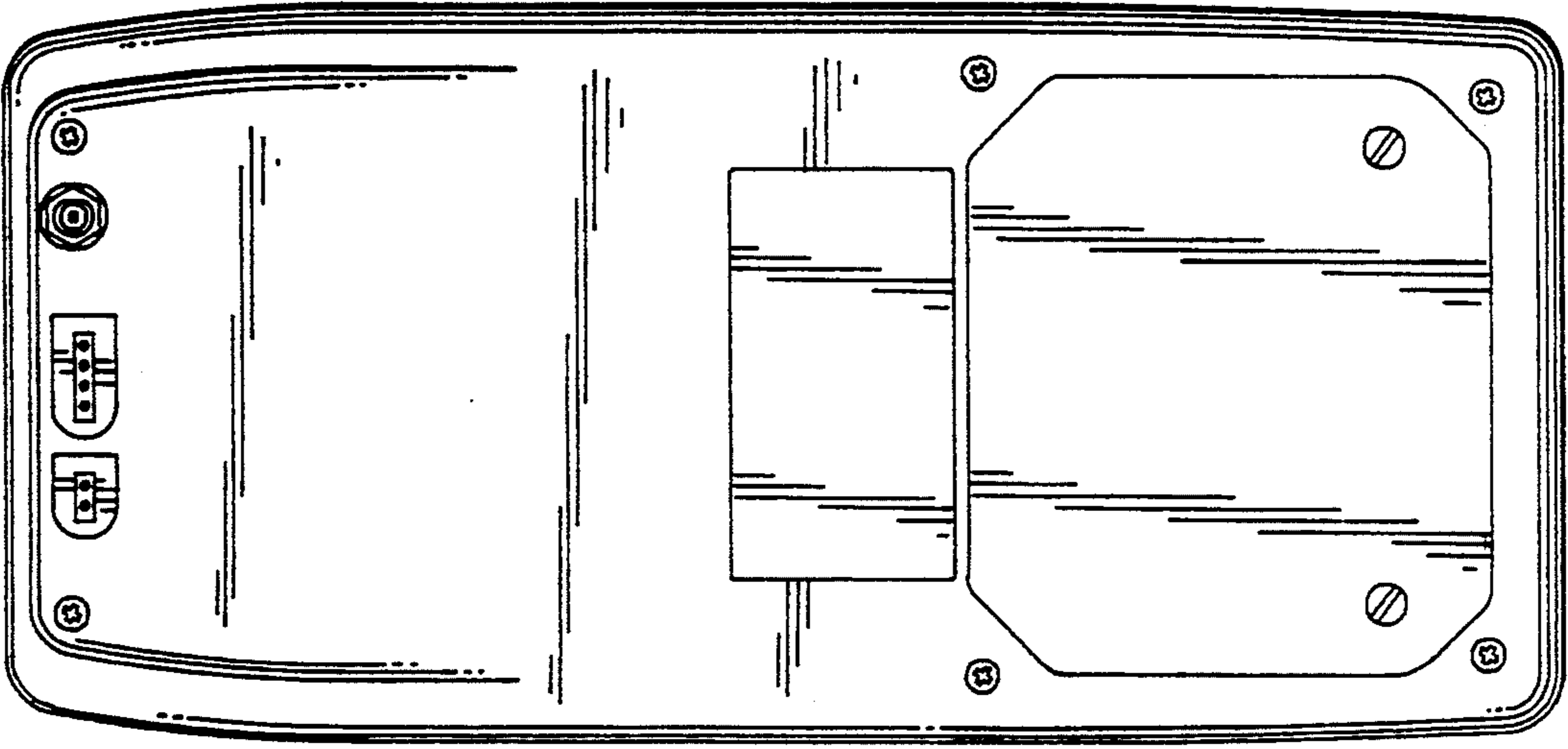

Fig. 4

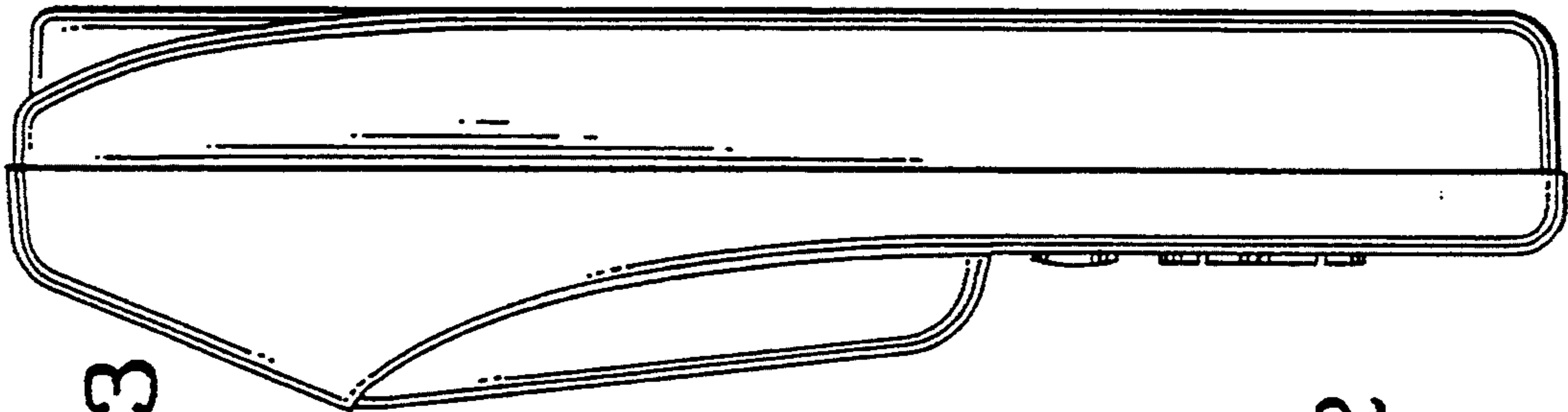

Fig. 3

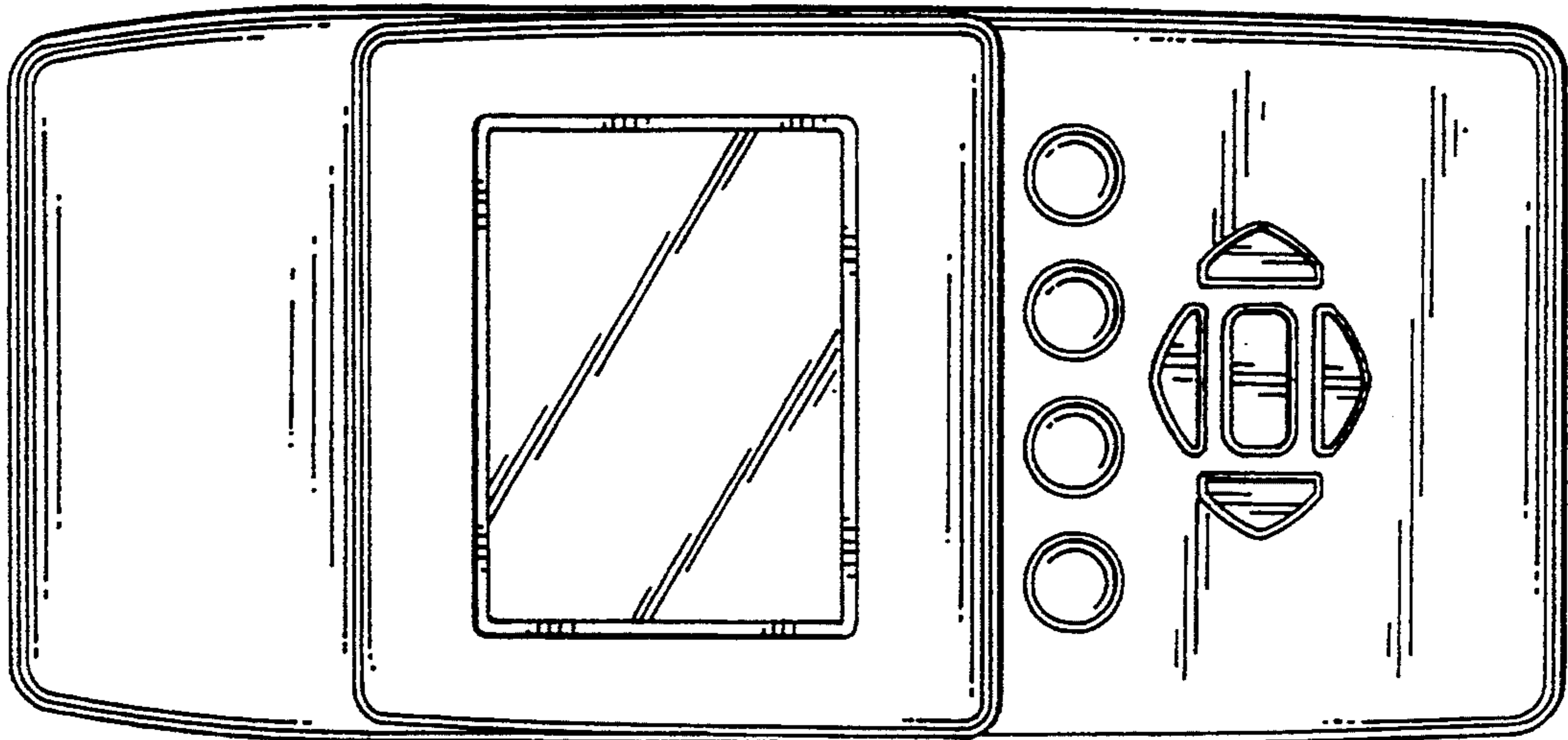

Fig. 2