



US00D355633S

# United States Patent [19]

[11] Patent Number: **Des. 355,633**

Whitney

[45] Date of Patent: **\*\* Feb. 21, 1995**

[54] **PERSONAL PONTOON**

4,856,446 8/1989 Herard ..... 114/61

[76] Inventor: **James M. Whitney**, R.R. 1 Box 110,  
Graettinger, Iowa 51342

*Primary Examiner*—Kay H. Chin  
*Attorney, Agent, or Firm*—Hugh E. Smith

[\*\*] Term: **14 Years**

[57] **CLAIM**

[21] Appl. No.: **16,948**

The ornamental design for a personal pontoon, as shown and described.

[22] Filed: **Dec. 30, 1993**

[52] U.S. Cl. .... **D12/316; D12/304;**  
D21/236

### DESCRIPTION

[58] Field of Search ..... **D12/300, 304, 310, 316;**  
114/61; D21/236

FIG. 1 is a front elevational view of the personal pontoon showing my new design;

[56] **References Cited**

FIG. 2 is a rear elevational view thereof;

### U.S. PATENT DOCUMENTS

FIG. 3 is a left side elevational view thereof;

D. 256,448 8/1980 Upchurch ..... D12/310  
4,295,236 10/1981 Upchurch ..... 114/61

FIG. 4 is a right side elevational view thereof;

FIG. 5 is a top plan view thereof;

FIG. 6 is a bottom plan view thereof; and,

FIG. 7 is an isometric view thereof.

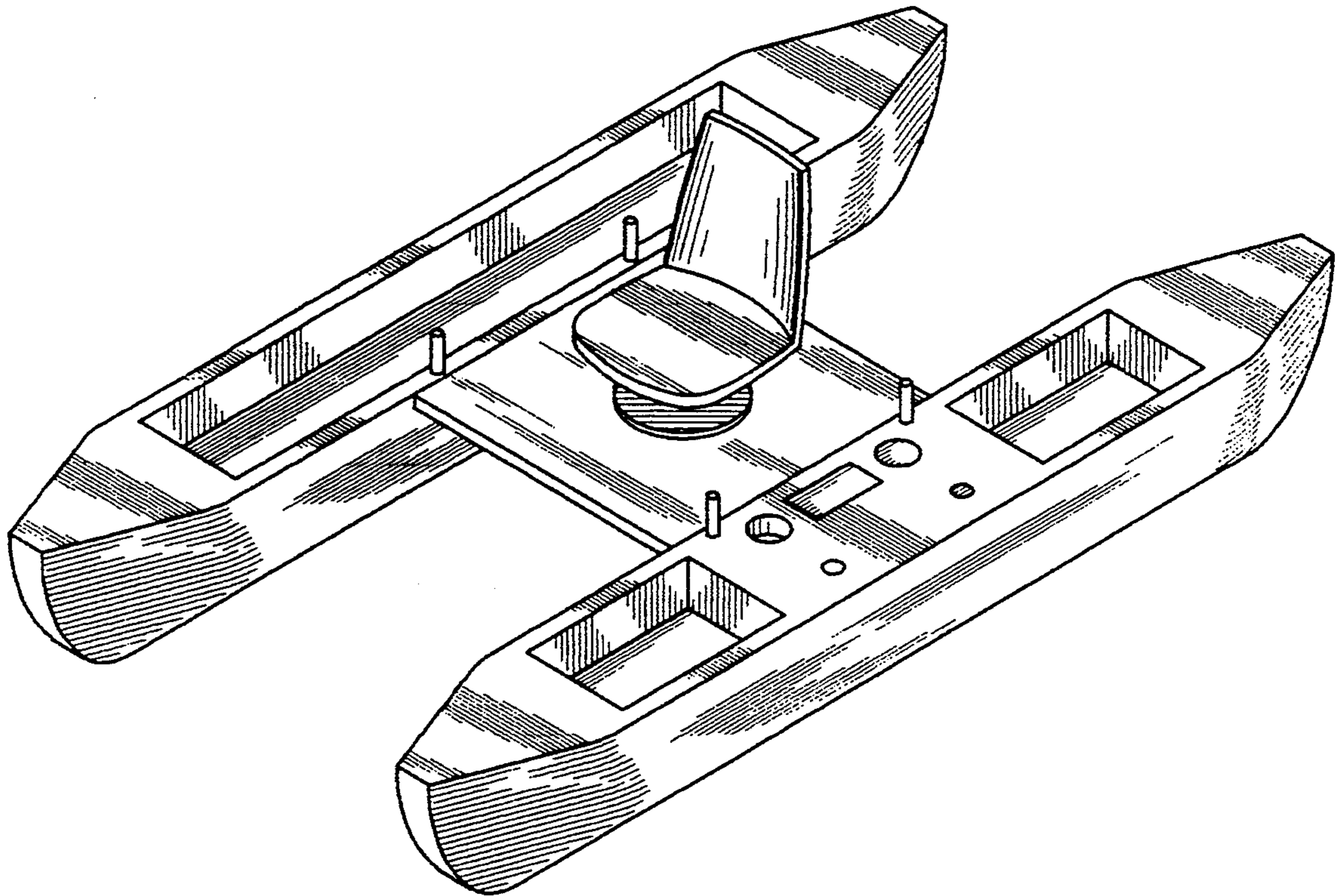

*FIG. 1*

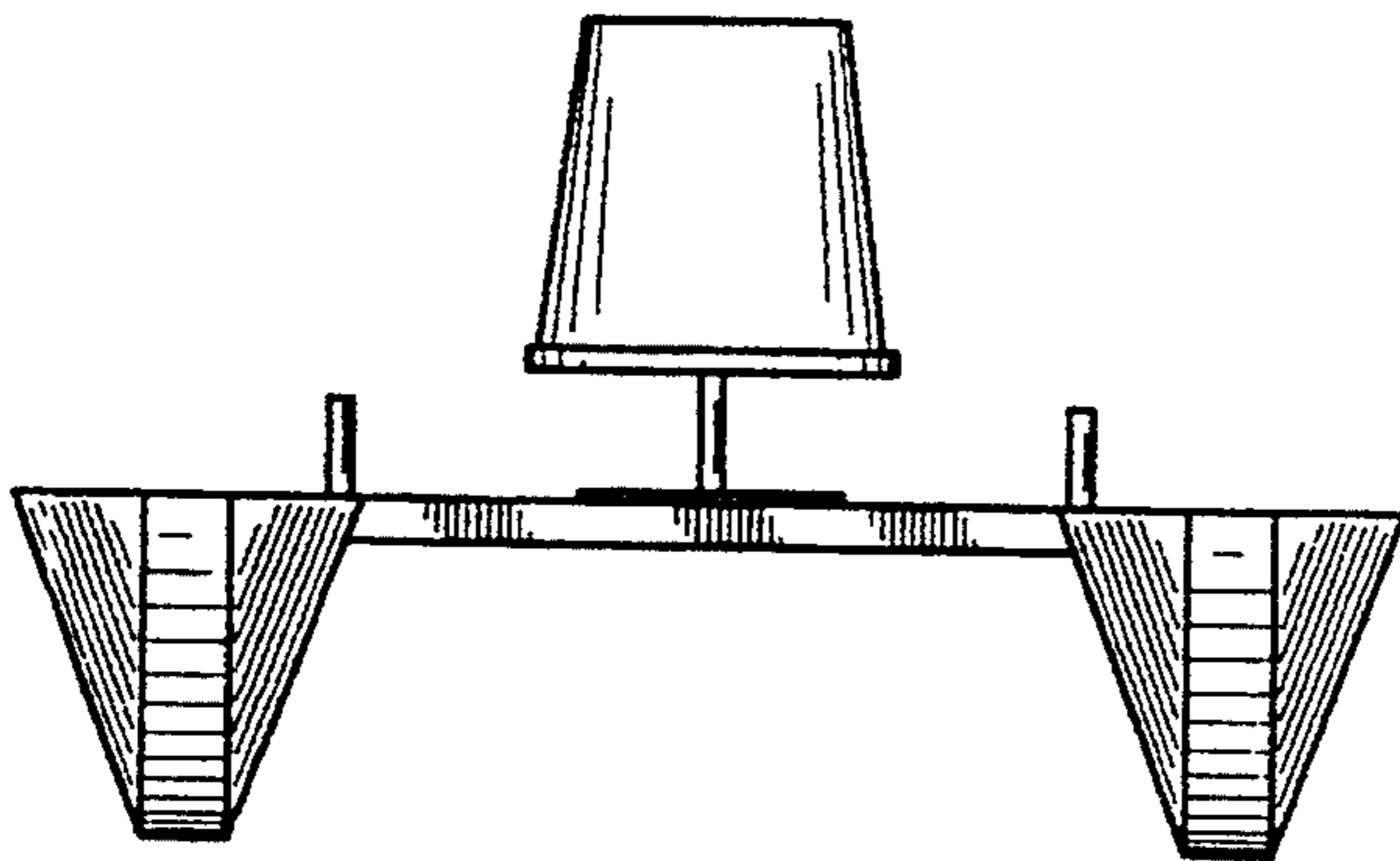

*FIG. 2*

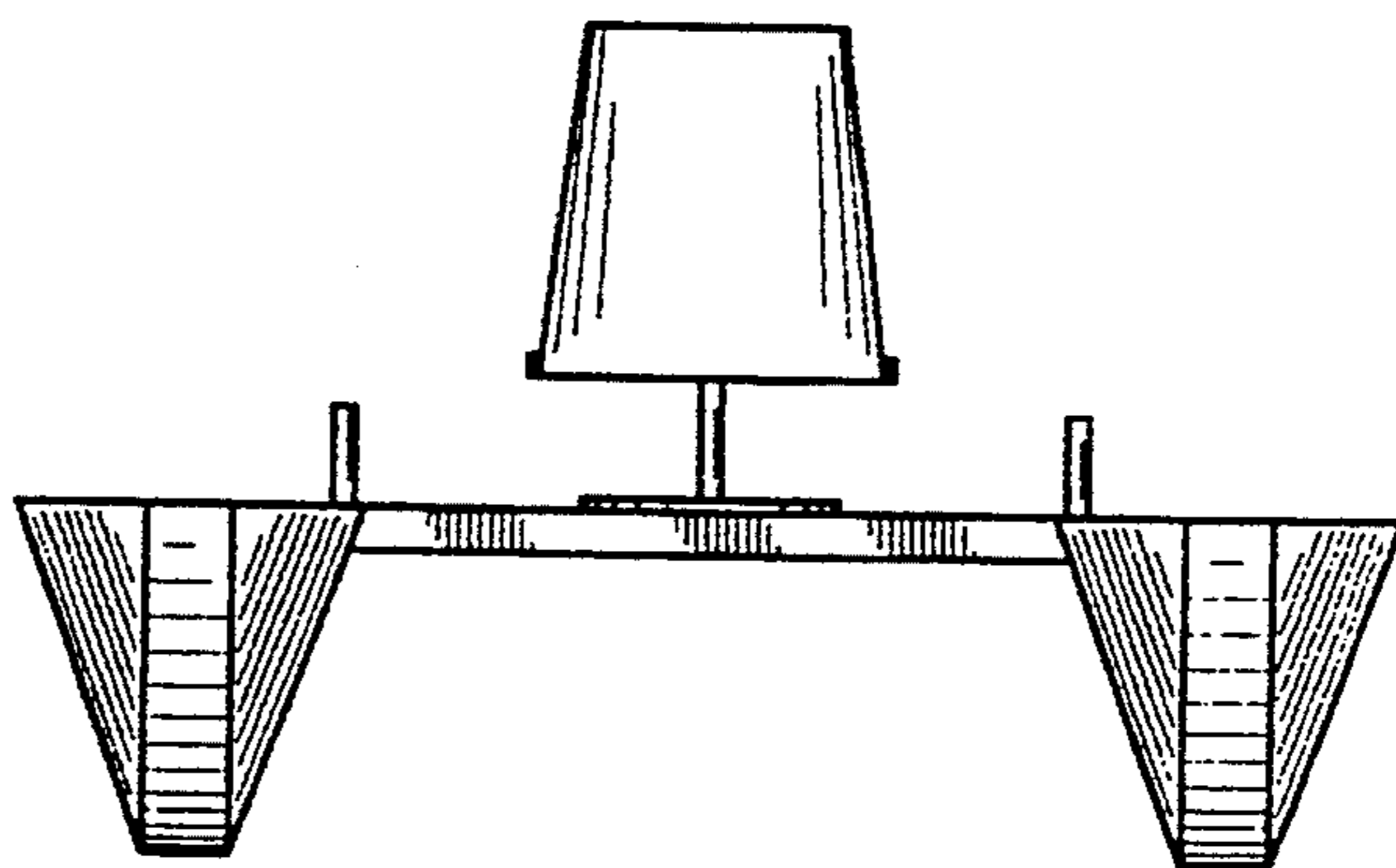

FIG. 3

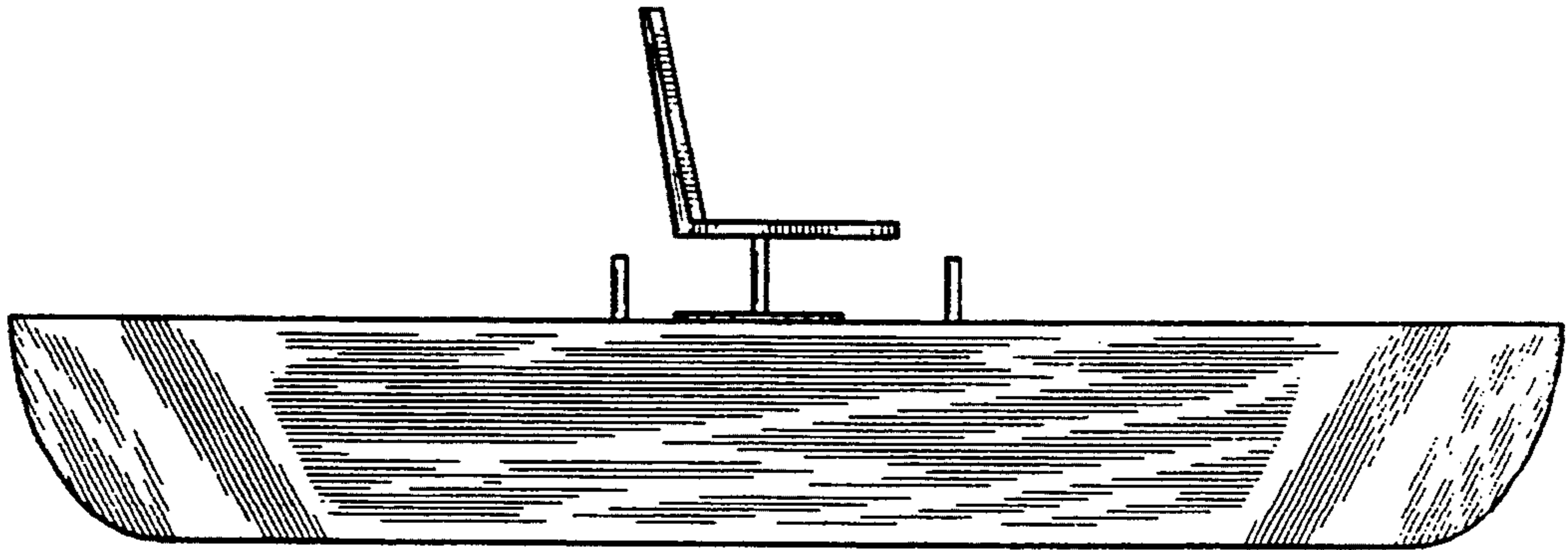

FIG. 4

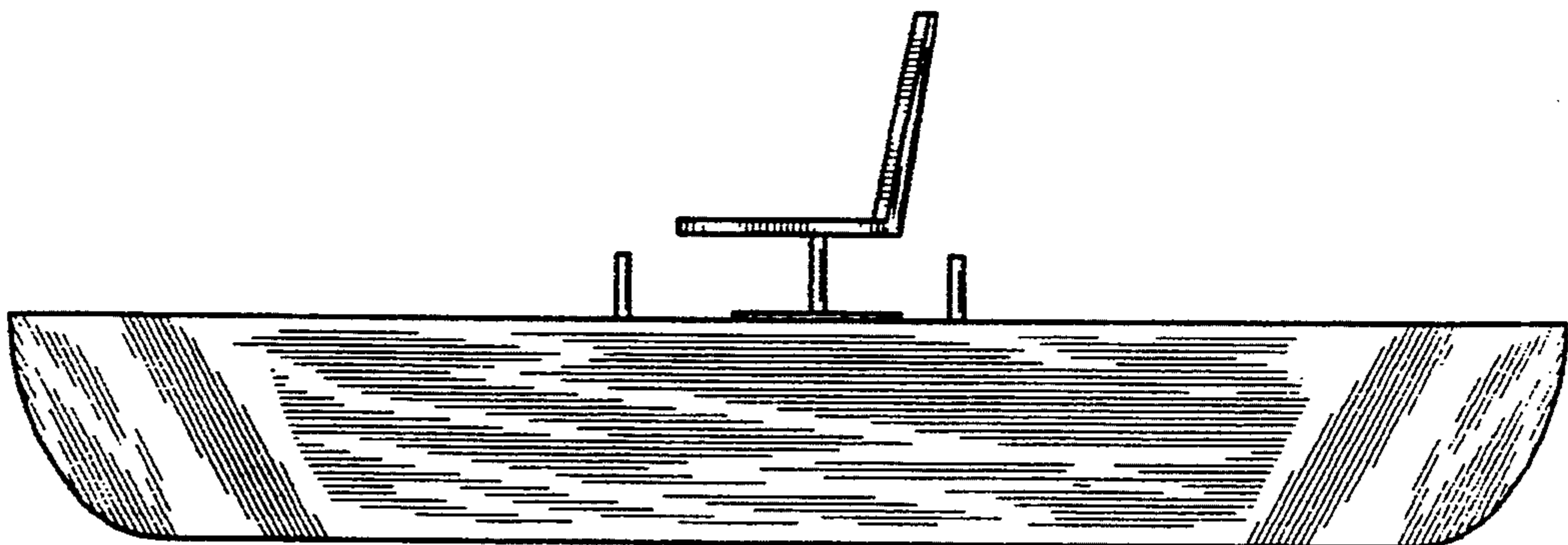

FIG. 5

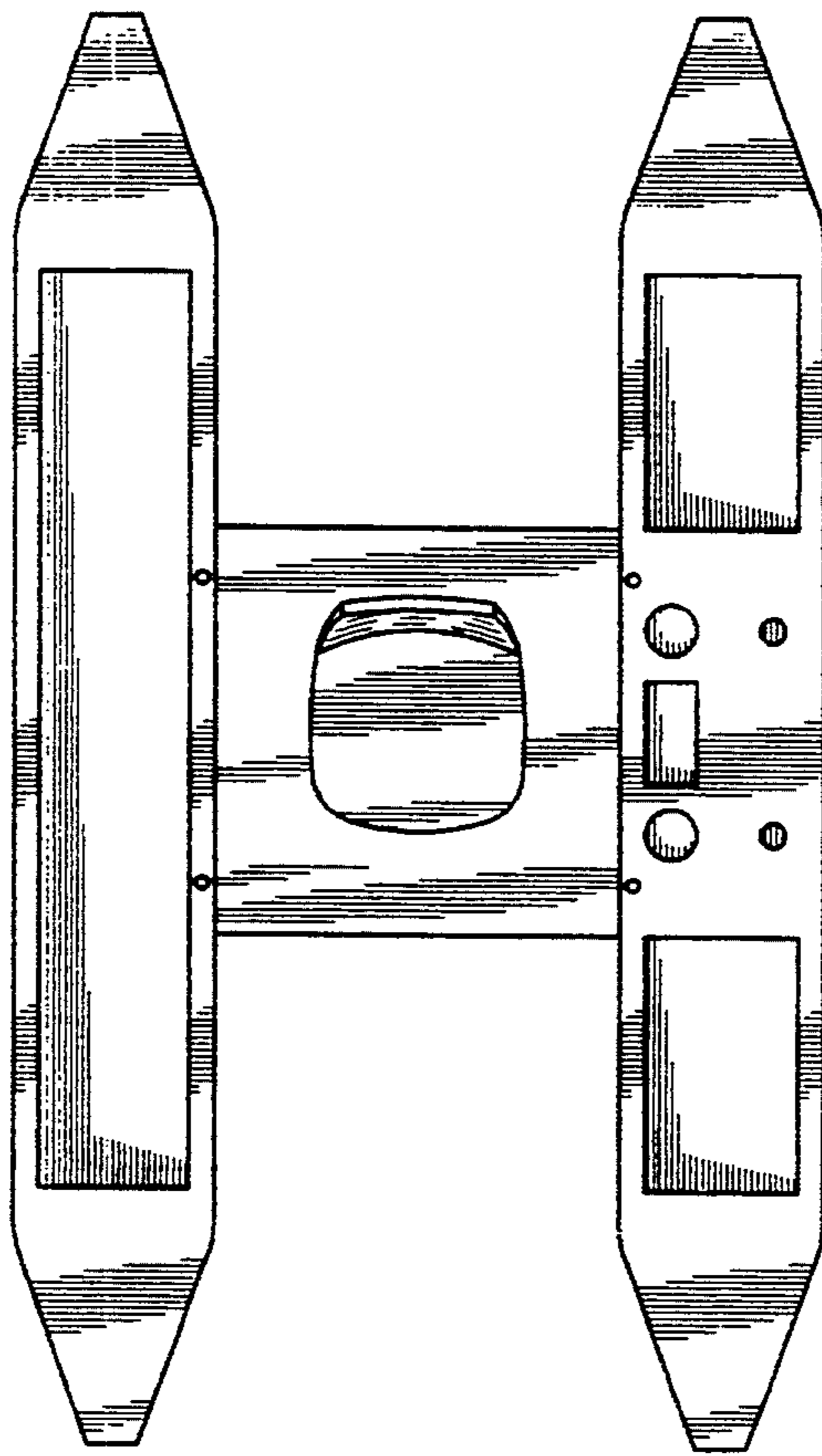

FIG. 6

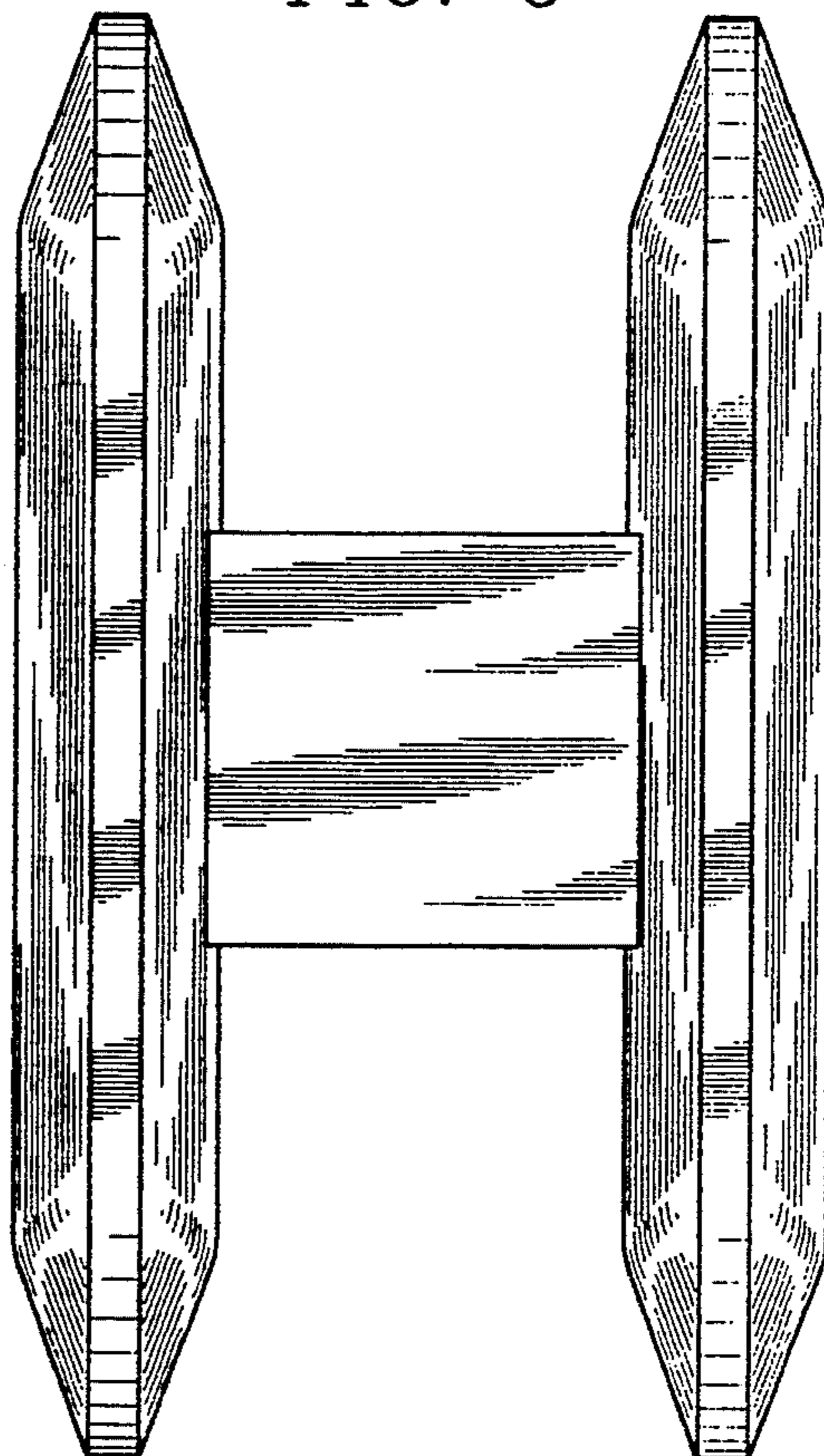



FIG. 7

