



US00D355422S

# United States Patent [19]

[11] Patent Number: Des. 355,422

Kimberlin

[45] Date of Patent: \*\* Feb. 14, 1995

- [54] MUFFLER FOR A JACKHAMMER
- [75] Inventor: Robert R. Kimberlin, Troutville, Va.
- [73] Assignee: Ingersoll-Rand Company, Woodcliff Lake, N.J.
- [\*\*] Term: 14 Years
- [21] Appl. No.: 340
- [22] Filed: Oct. 9, 1992
- [52] U.S. Cl. .... D15/21
- [58] Field of Search ..... D23/249-259;  
D12/194; 181/212, 217, 227, 230, 252, 254;  
D15/122, 123, 128, 138, 99; 175/135; 173/80,  
83.5

Attorney, Agent, or Firm—John J. Selko

## [57] CLAIM

The ornamental design for a muffler for a jackhammer, as shown and described.

## DESCRIPTION

FIG. 1 is a front view of a muffler for a jackhammer, showing my new design;  
 FIG. 2 is a left side view thereof;  
 FIG. 2 is a left side view thereof;  
 FIG. 2 is a also right side view thereof;  
 FIG. 3 is a back view thereof;  
 FIG. 4 is a top view thereof;  
 FIG. 5 is a bottom view thereof;  
 FIG. 6 is a top perspective view showing the top, side and front thereof;  
 FIG. 7 is a side perspective view showing a side and front thereof;  
 FIG. 8 is a top perspective view showing the top, side and front thereof;  
 FIG. 9 is a bottom perspective view showing the bottom and back thereof; and,  
 FIG. 10 is a side perspective view showing the top, side and back thereof.

## [56] References Cited

### U.S. PATENT DOCUMENTS

1,115,704	11/1914	Manes .....	181/230
2,166,218	7/1939	Morrison .....	181/230 X
2,949,975	8/1960	Plummer .....	181/230
3,379,278	4/1968	Skowron .....	181/230
3,815,705	6/1974	Bennett .....	181/230
4,662,474	5/1987	Cheng .....	181/230
5,189,267	2/1993	Ligman .....	181/230

Primary Examiner—A. Hugo Word  
 Assistant Examiner—Eric M. Watterson

Elements shown in dotted are environmental only, and form no part of the claimed design.

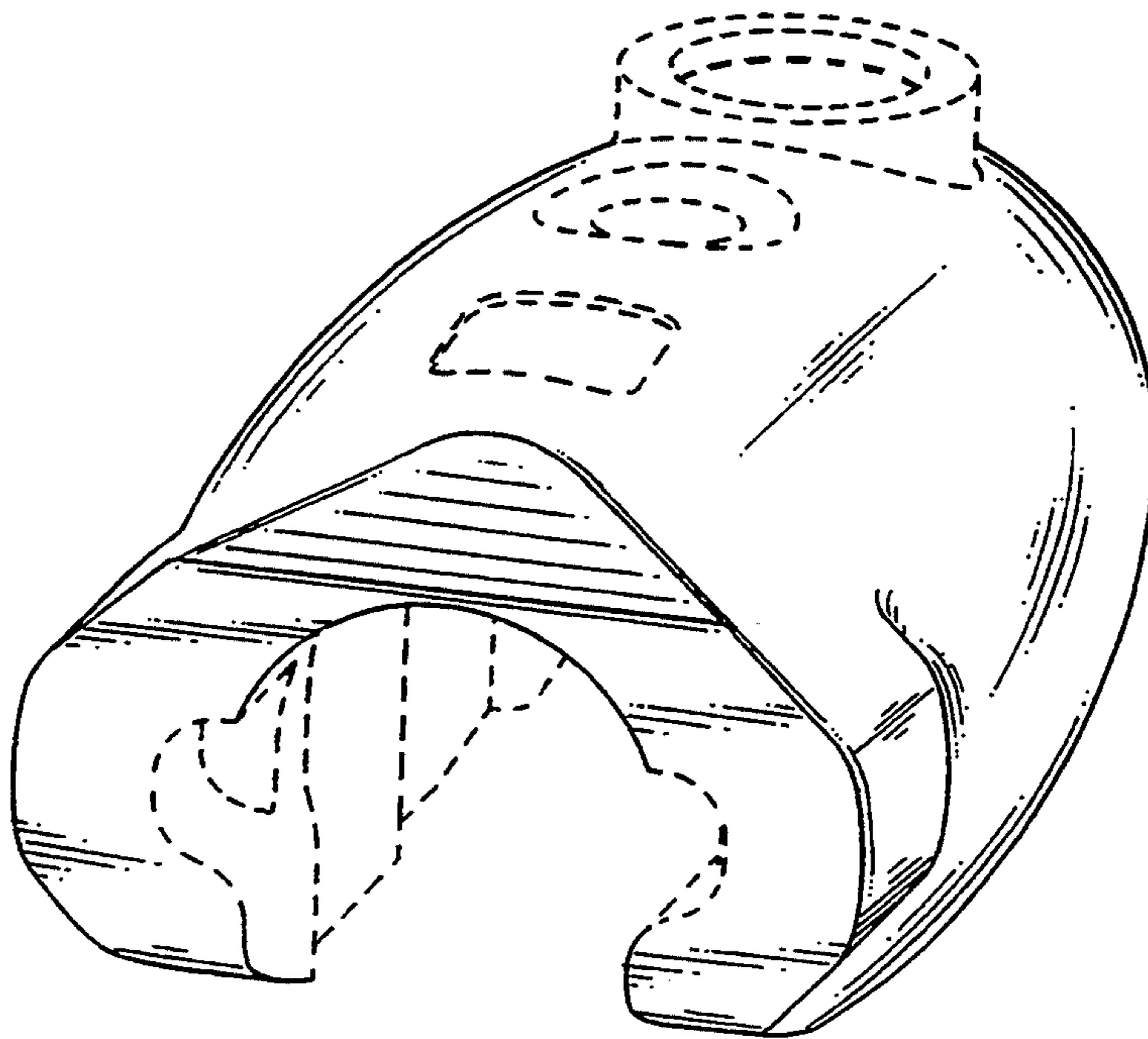

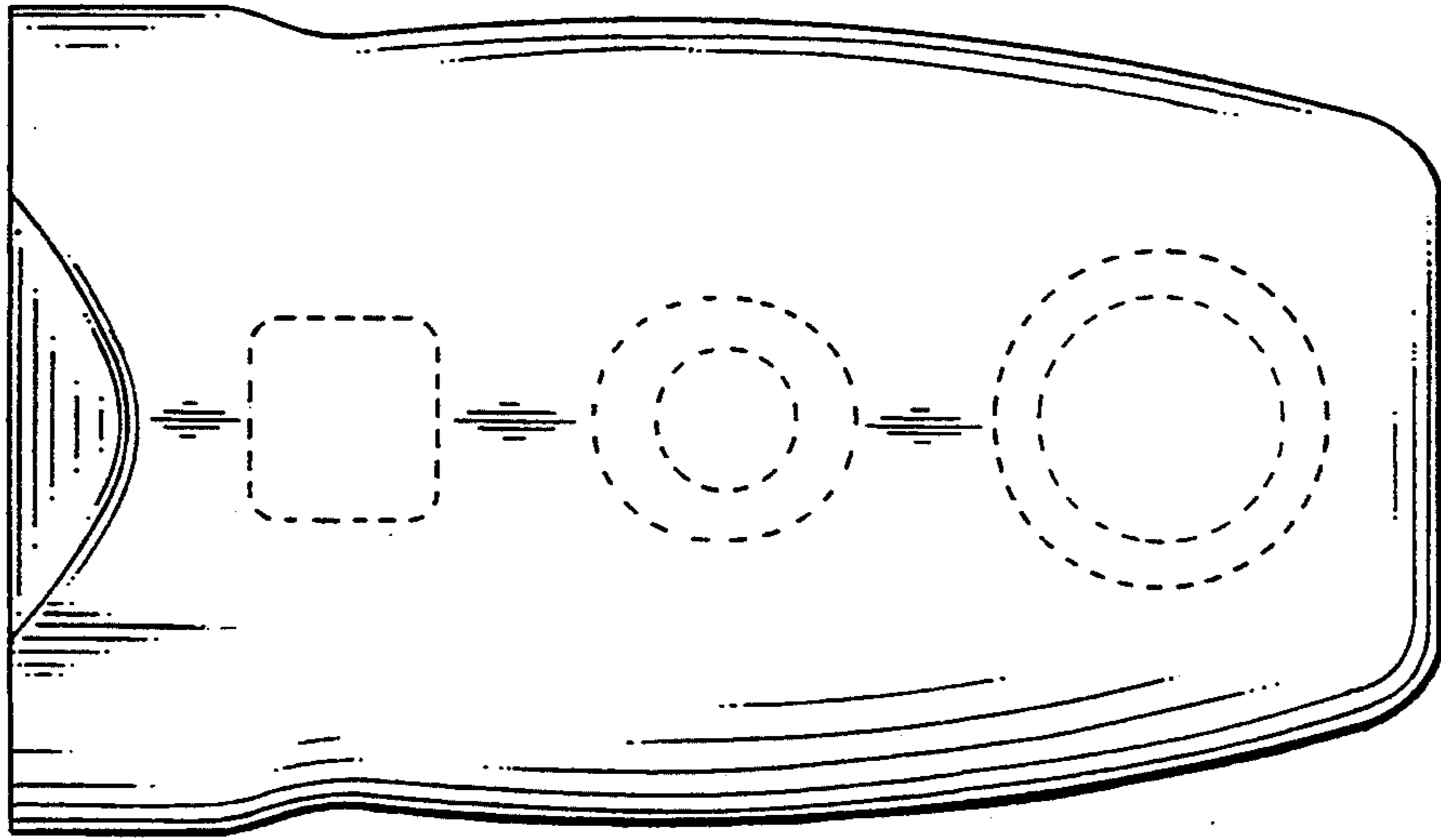

FIG. 1

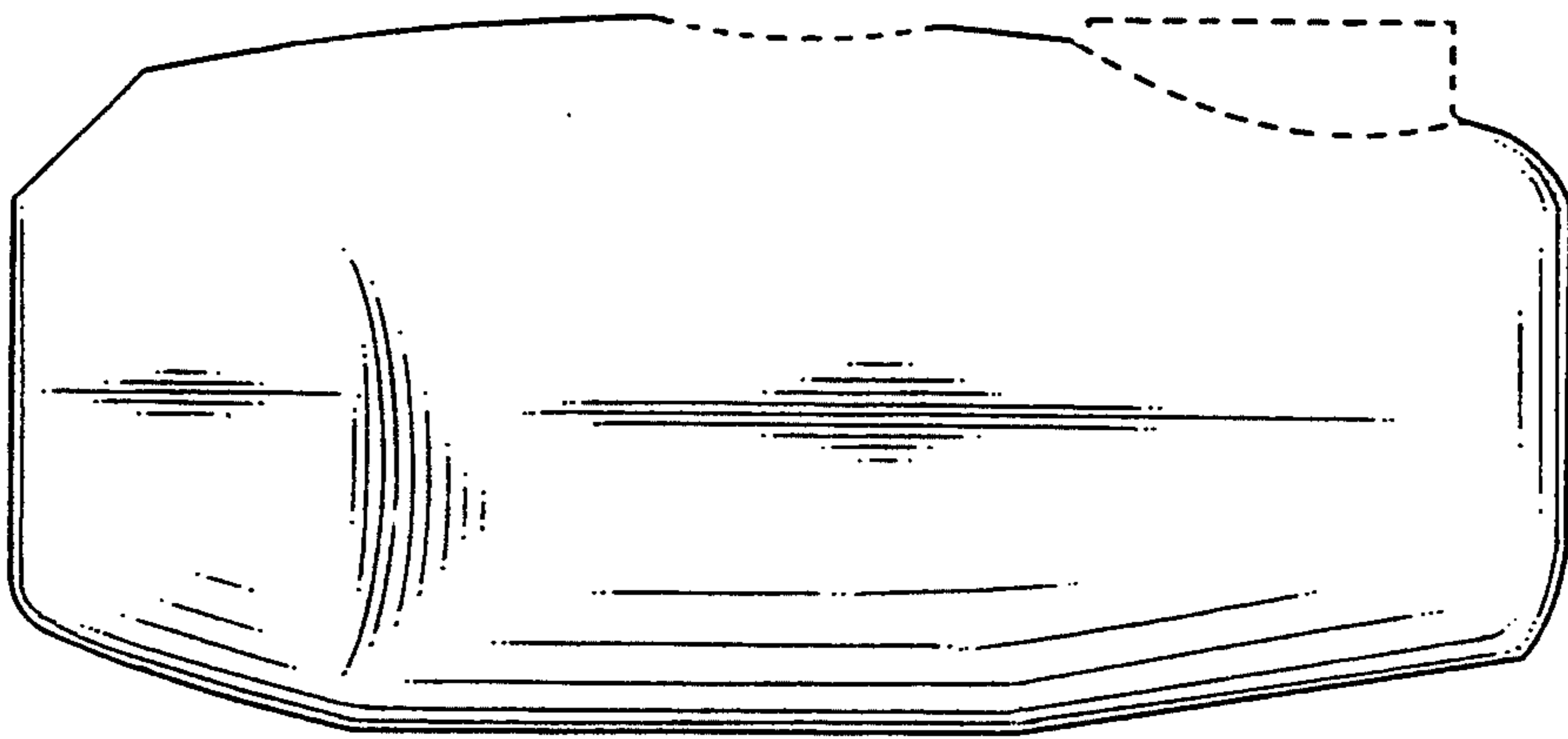

FIG. 2

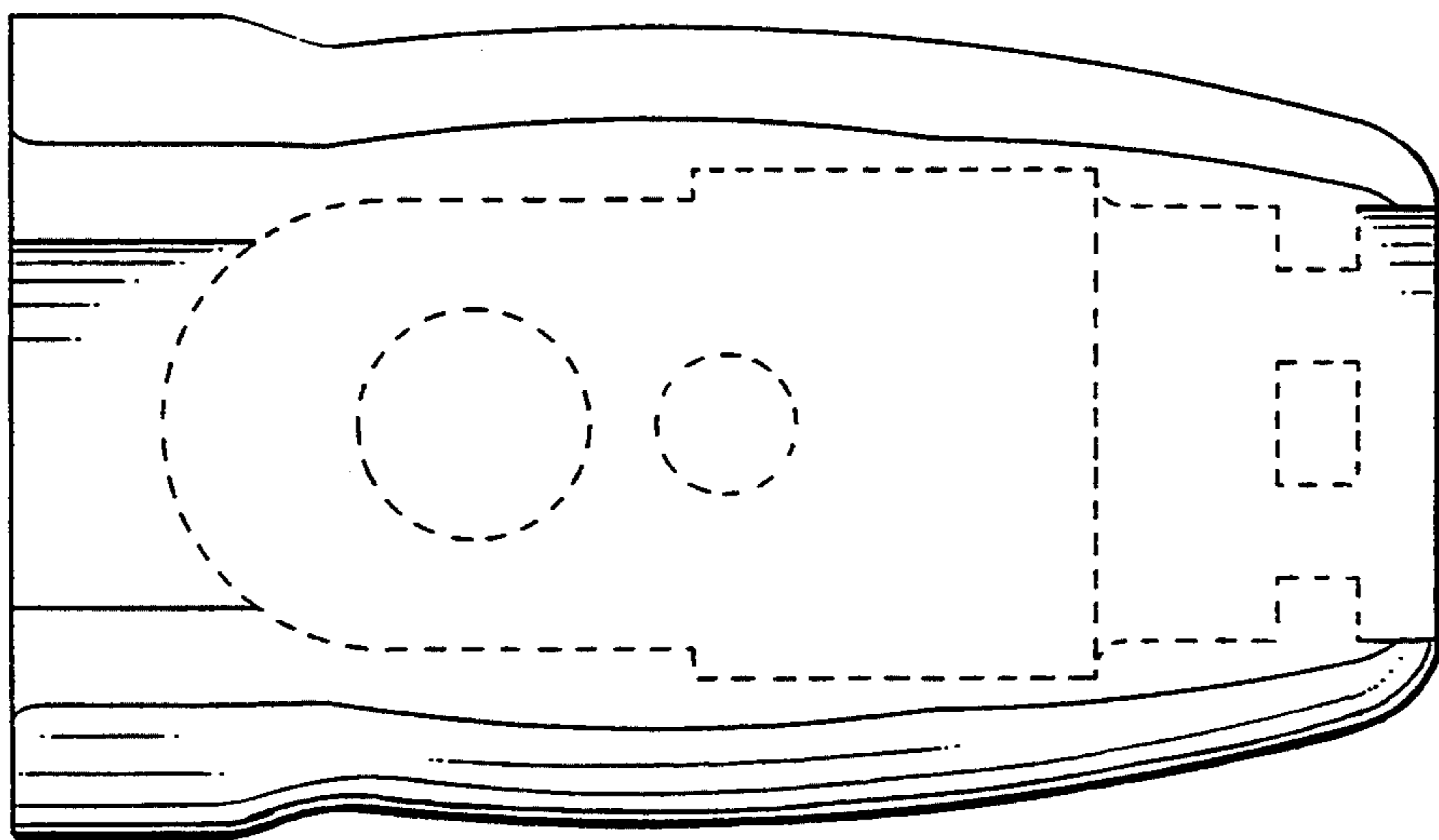

FIG. 3

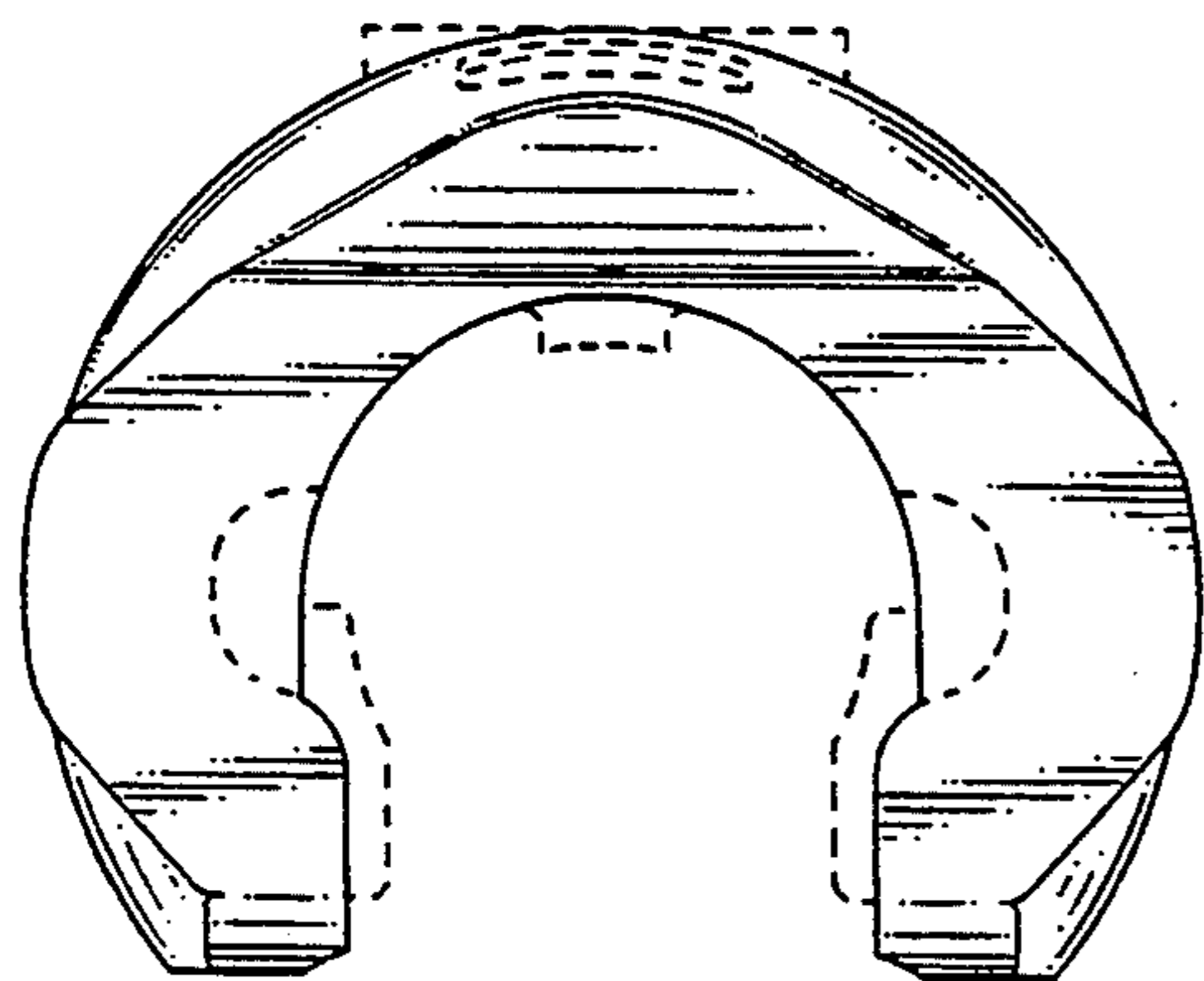

FIG. 4

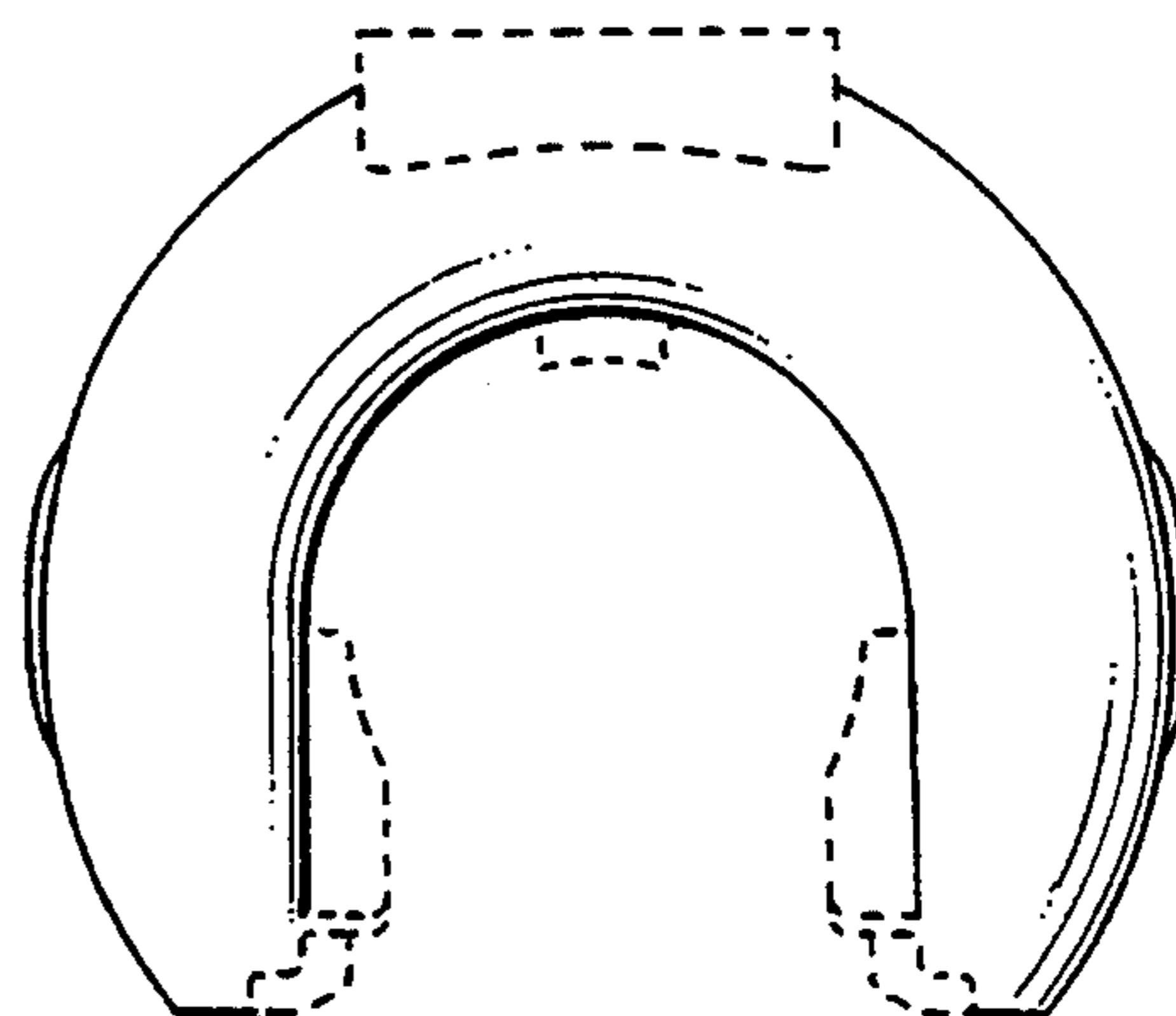

FIG. 5

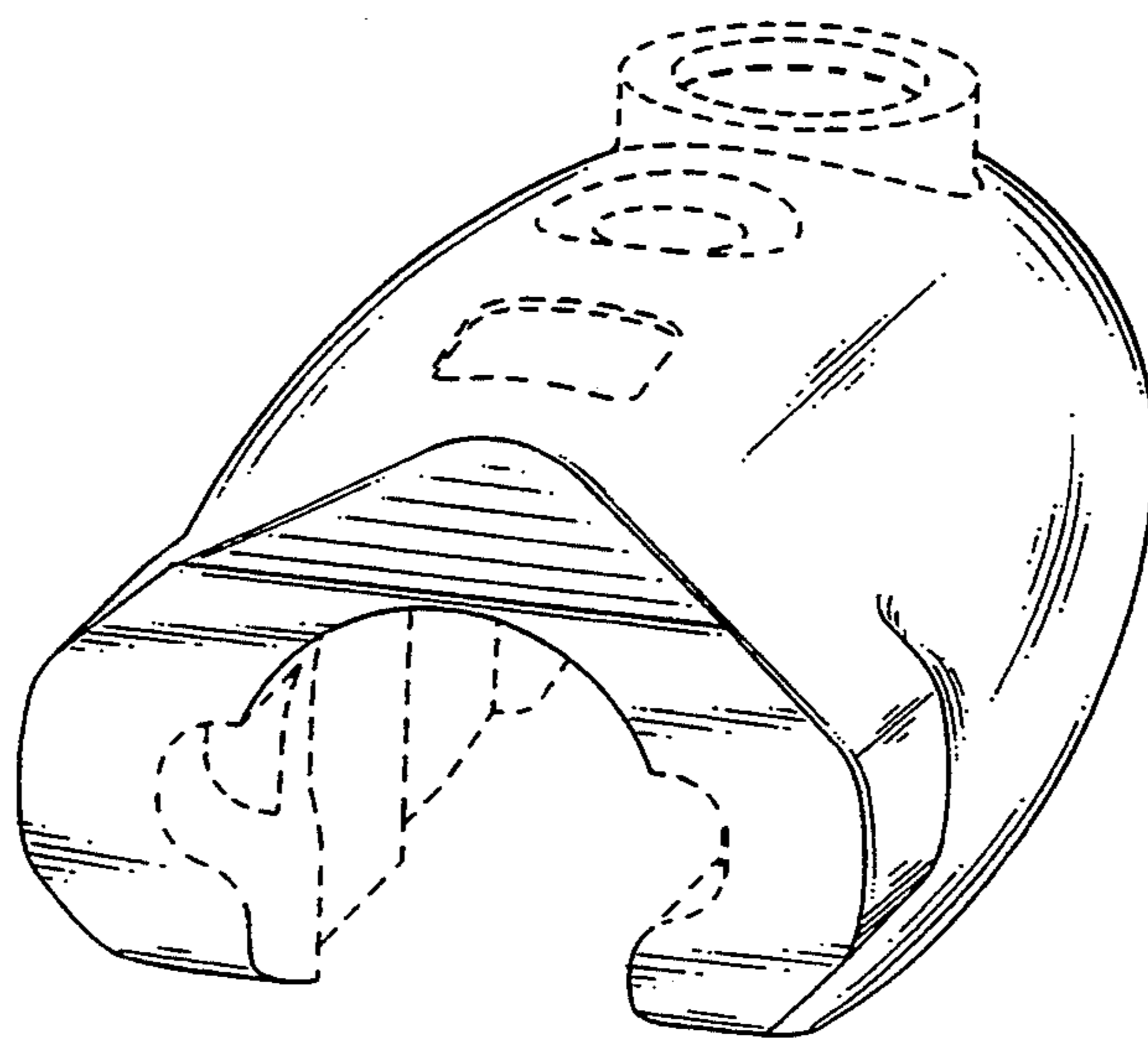

FIG. 6

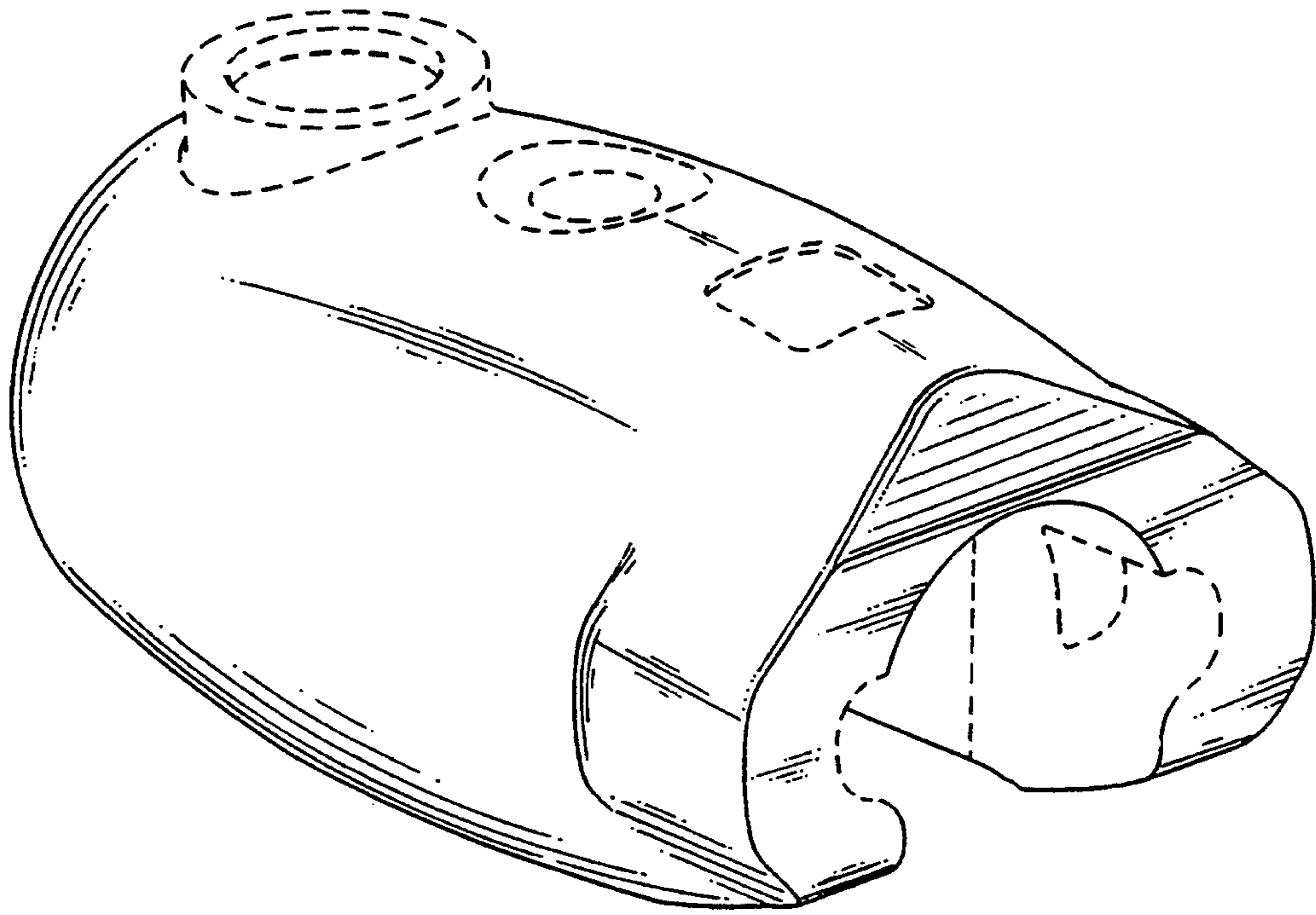

FIG. 7

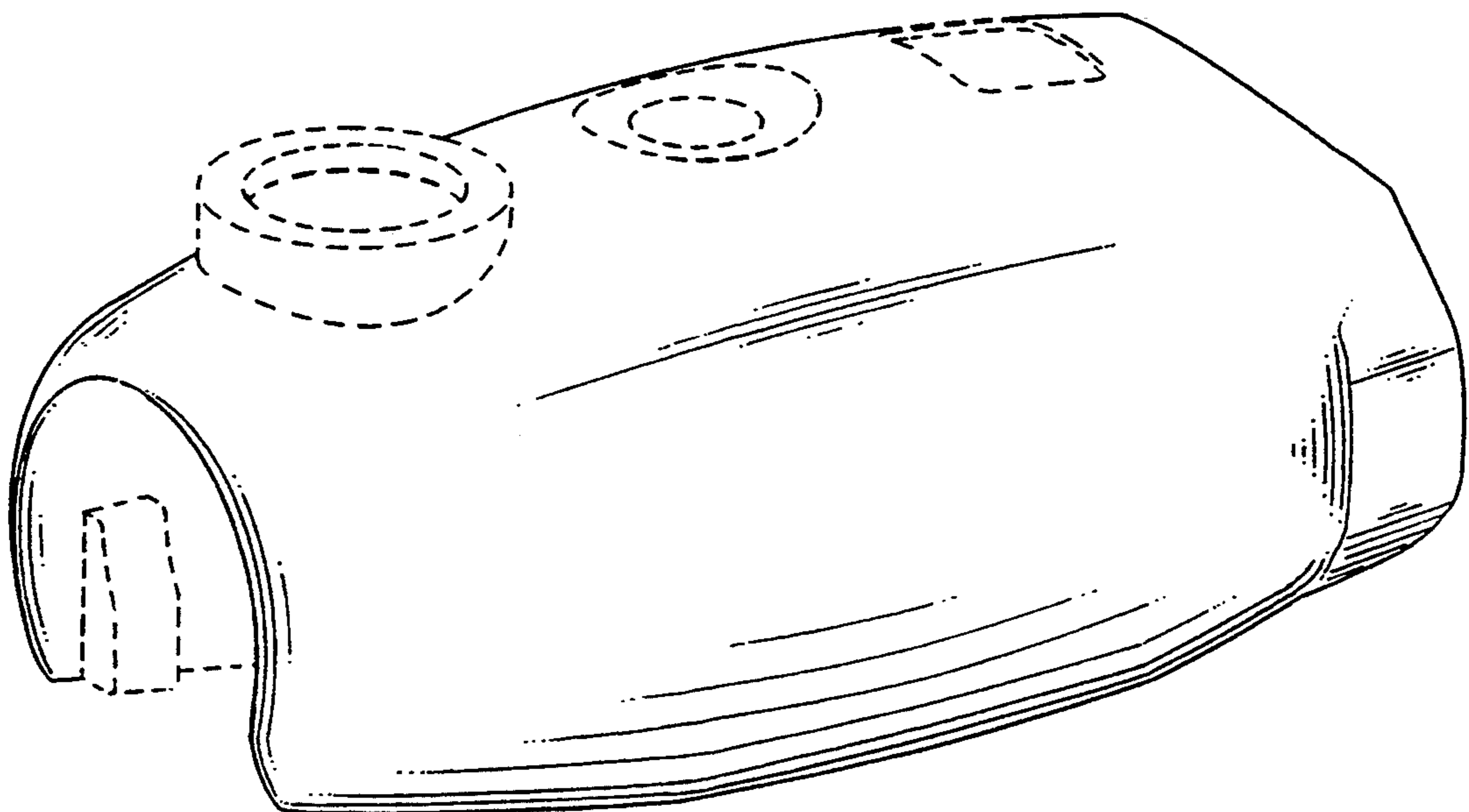
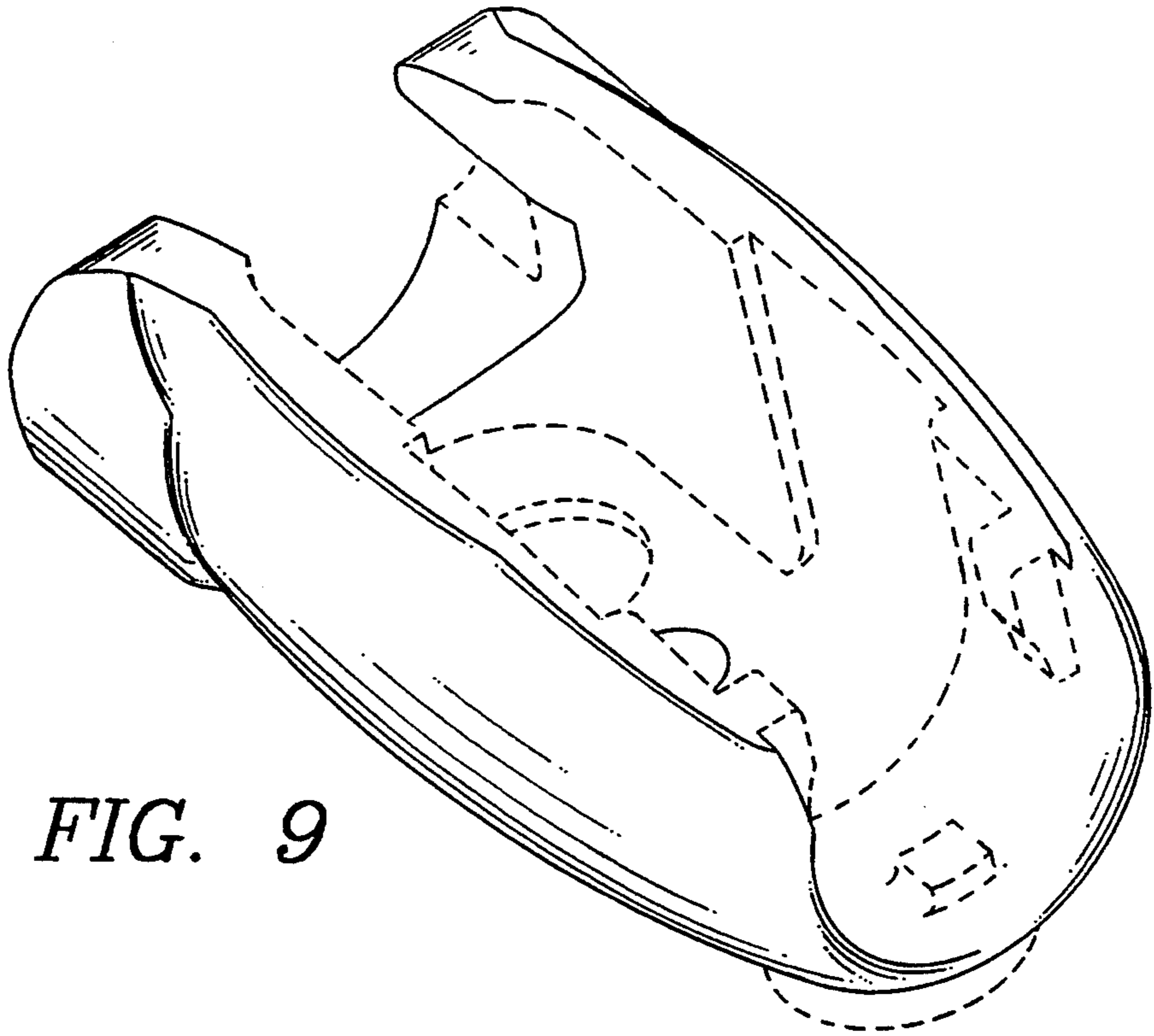
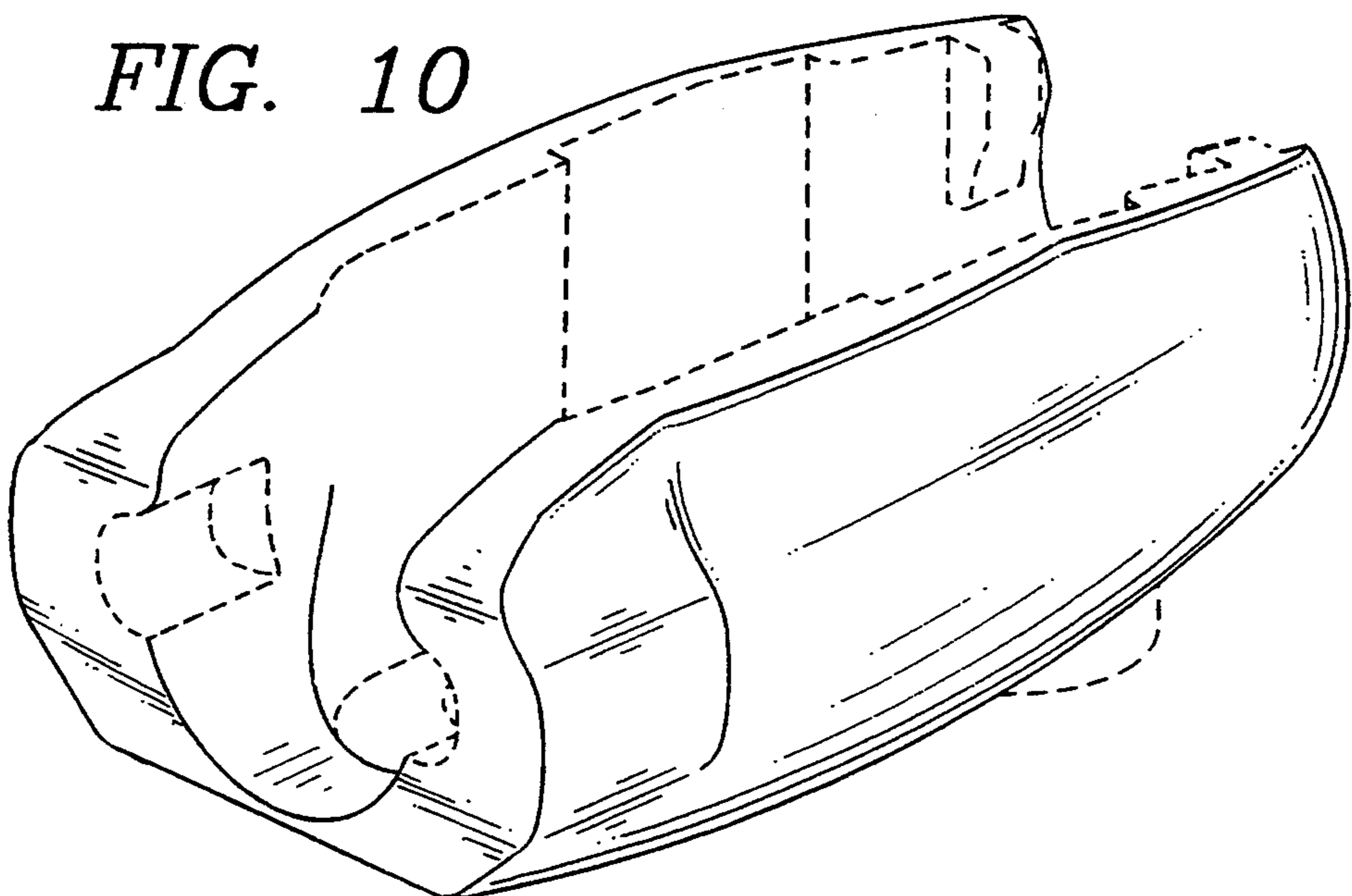

FIG. 8





*FIG. 9*



*FIG. 10*