



US00D355415S

United States Patent [19] Isozaki

[11] Patent Number: **Des. 355,415**
[45] Date of Patent: **** Feb. 14, 1995**

[54] VIDEO IMAGES PLAYBACK UNIT
[75] Inventor: **Makoto Isozaki**, Tokyo, Japan
[73] Assignee: **Fuji Photo Film Co., Ltd.**, Kanagawa, Japan
[**] Term: **14 Years**
[21] Appl. No.: **11,873**
[22] Filed: **Aug. 17, 1993**
[30] Foreign Application Priority Data

Feb. 25, 1993 [JP] Japan 5-5397
[52] U.S. Cl. **D14/135; D16/237**
[58] Field of Search D16/200, 202, 219, 237;
D14/135, 136, 217, 299, 124, 125; 358/906,
909.1; 348/373-376, 207

[56] References Cited

U.S. PATENT DOCUMENTS

D. 263,583 3/1982 Kawai D14/135
D. 346,168 4/1994 Tai D14/217
5,084,775 1/1992 Kodama et al. 358/335
5,146,353 9/1992 Isoguchi et al. 358/909.1

FOREIGN PATENT DOCUMENTS

2-70180 3/1990 Japan H04N 5/225
4-137866 5/1992 Japan H04N 5/225

OTHER PUBLICATIONS

Video Magazine, Jan. 1993 p. 46 (Philips's CD player).

Primary Examiner—Bernard Ansher
Assistant Examiner—Adir Aronovich
Attorney, Agent, or Firm—Young & Thompson

[57] CLAIM

The ornamental design for a video images playback unit, as shown and described.

DESCRIPTION

FIG. 1 is a top, front and side perspective view of a video images playback unit, showing my new design; FIG. 2 is a front elevational view thereof; FIG. 3 is a rear elevational view thereof; FIG. 4 is a top plan view thereof; FIG. 5 is a bottom plan view thereof; FIG. 6 is a side elevational view thereof from the left of FIG. 2; FIG. 7 is a side elevational view thereof from the right of FIG. 2; and, FIG. 8 is a front, top and side perspective view thereof showing a cover thereof raised. The broken line showing of a tape and a remote control unit is for illustrative purposes only and forms no part of the claimed design.

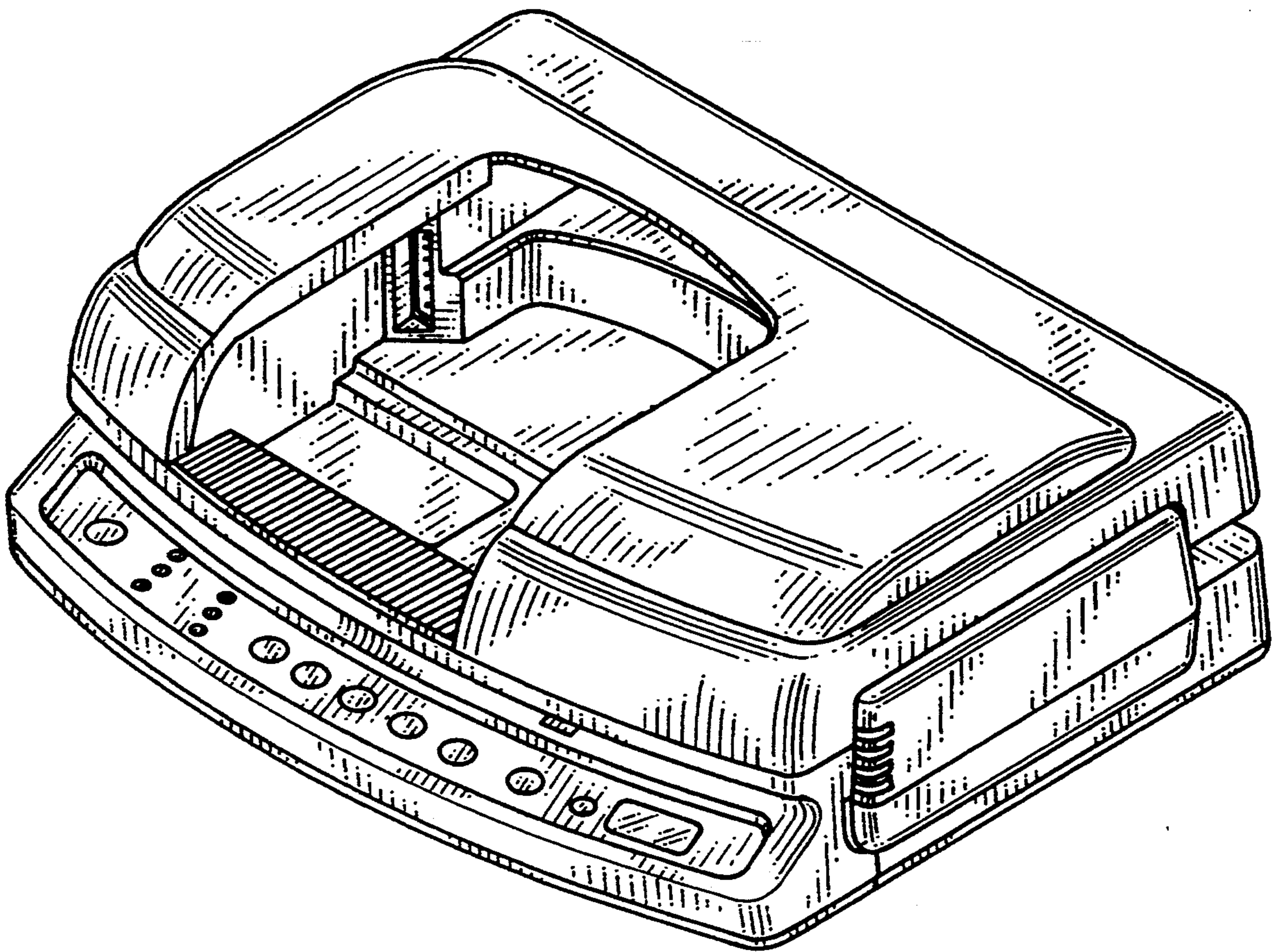

FIG. 1

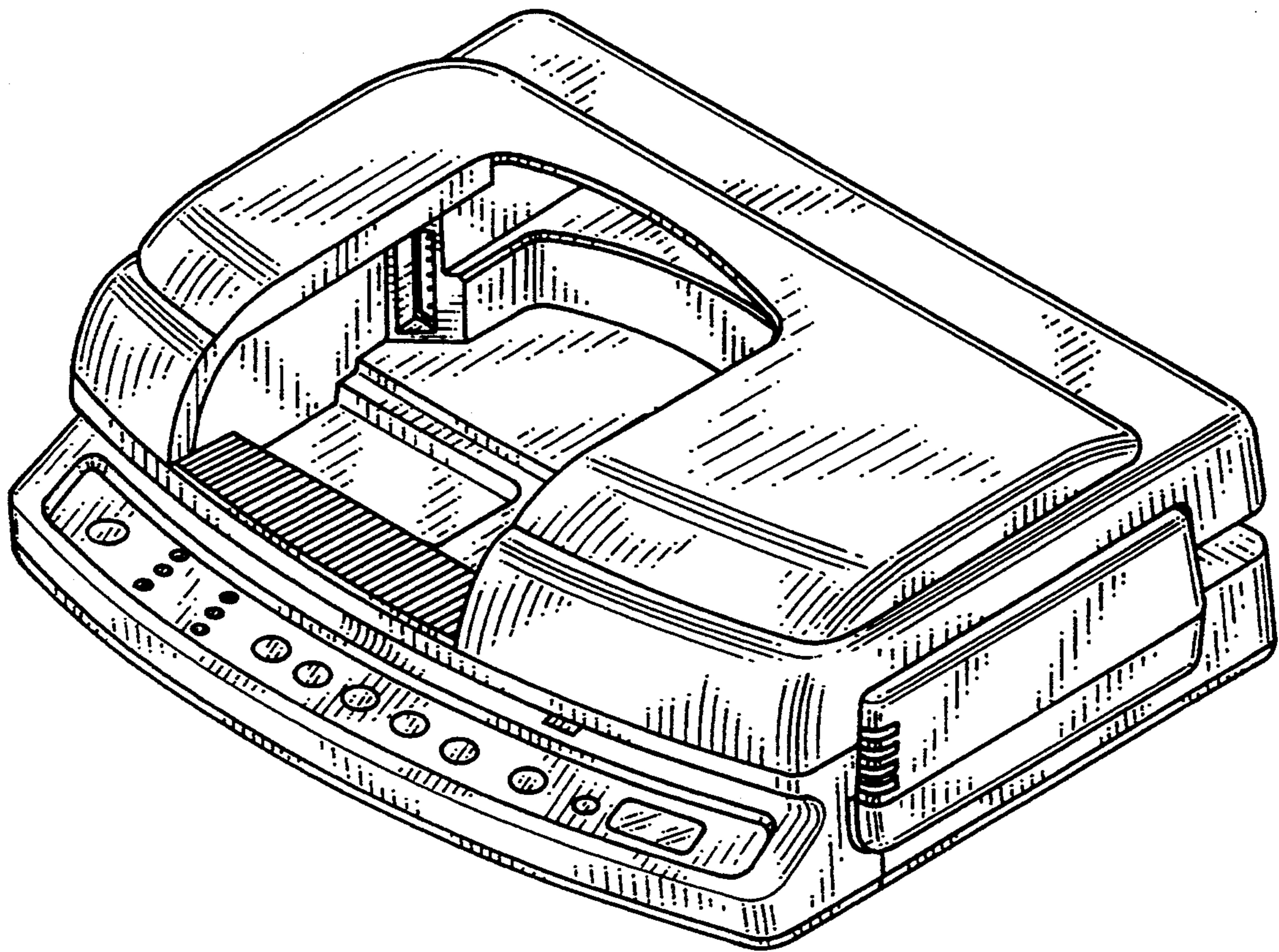

FIG. 2

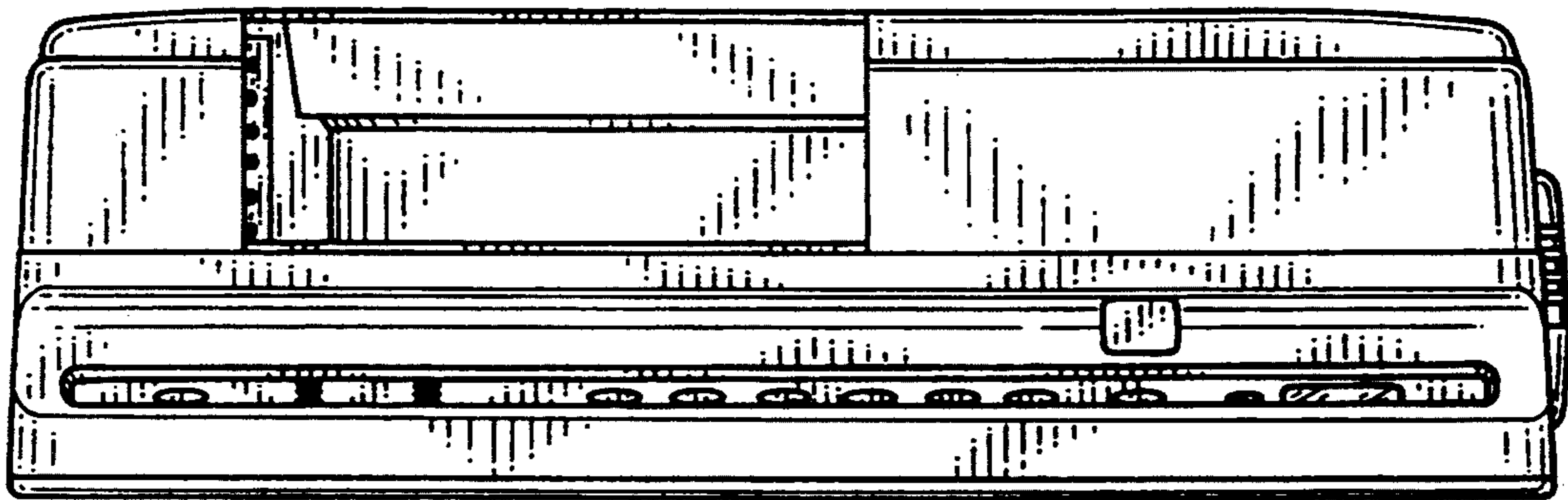

FIG. 3

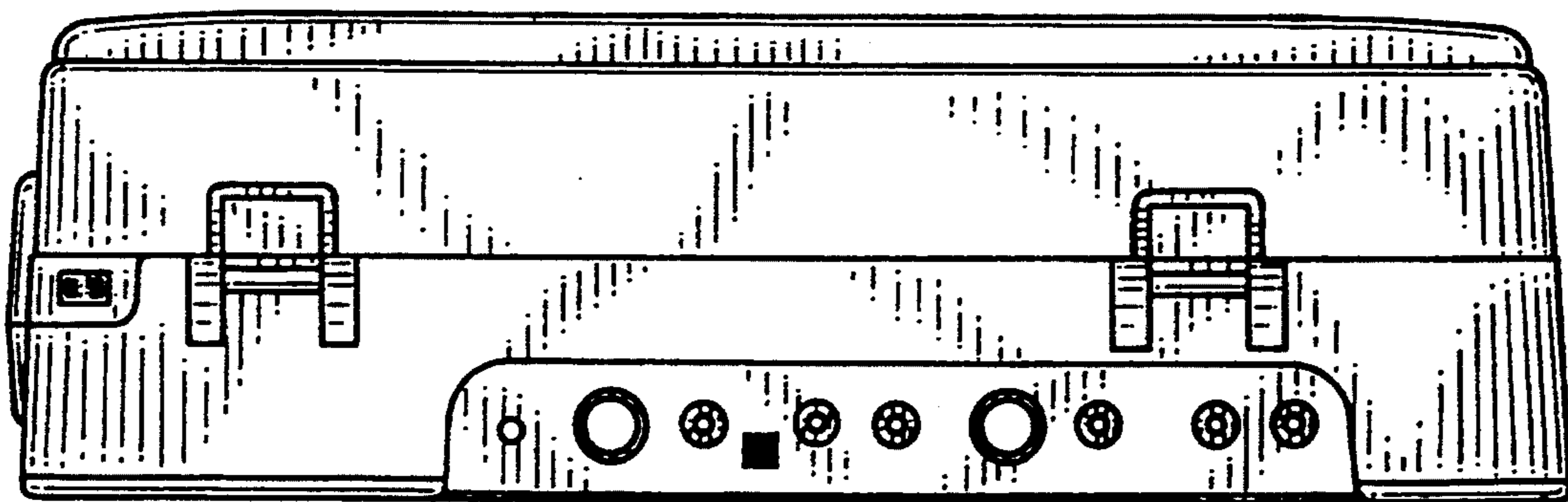

FIG. 4

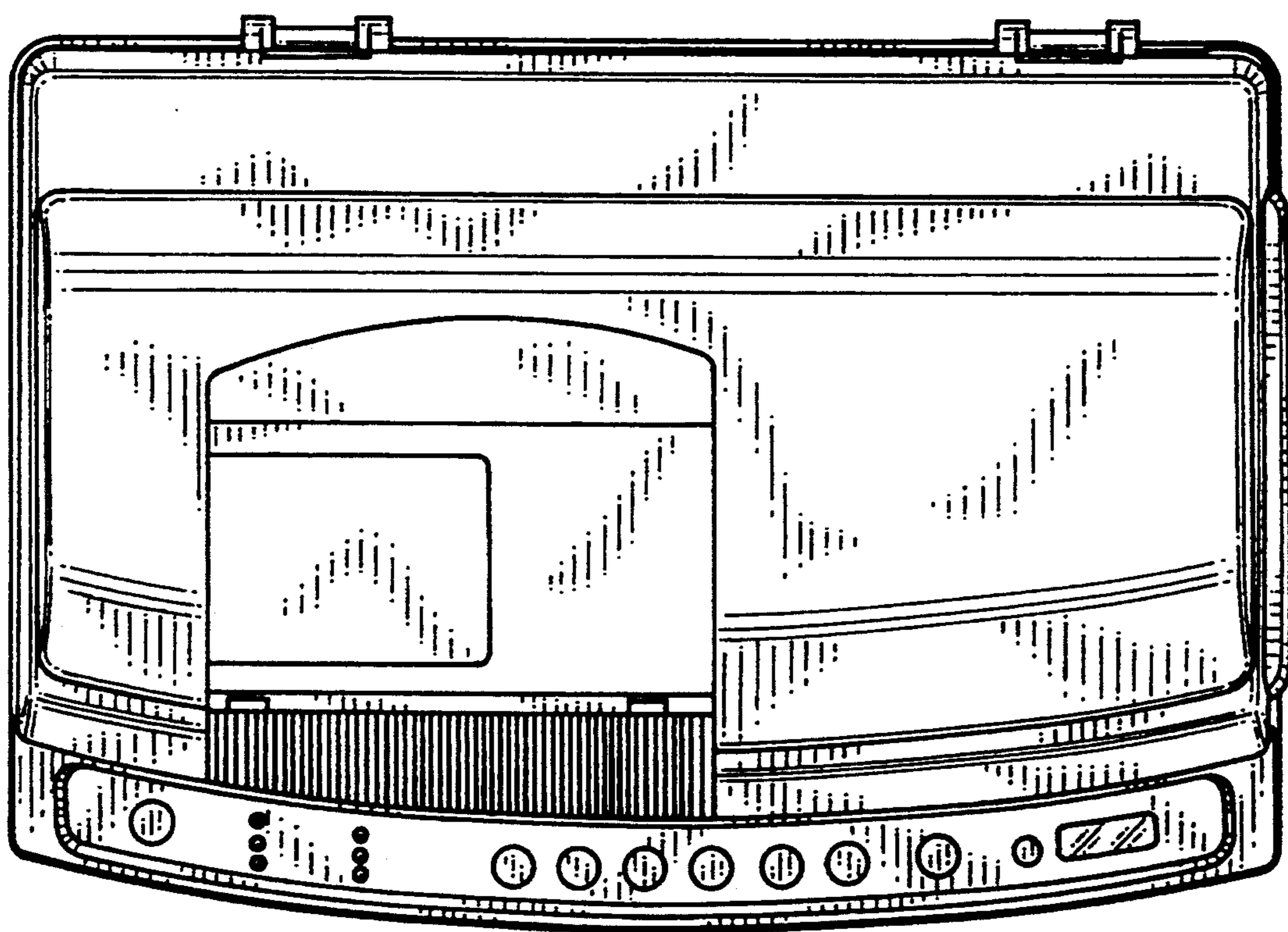

FIG. 5

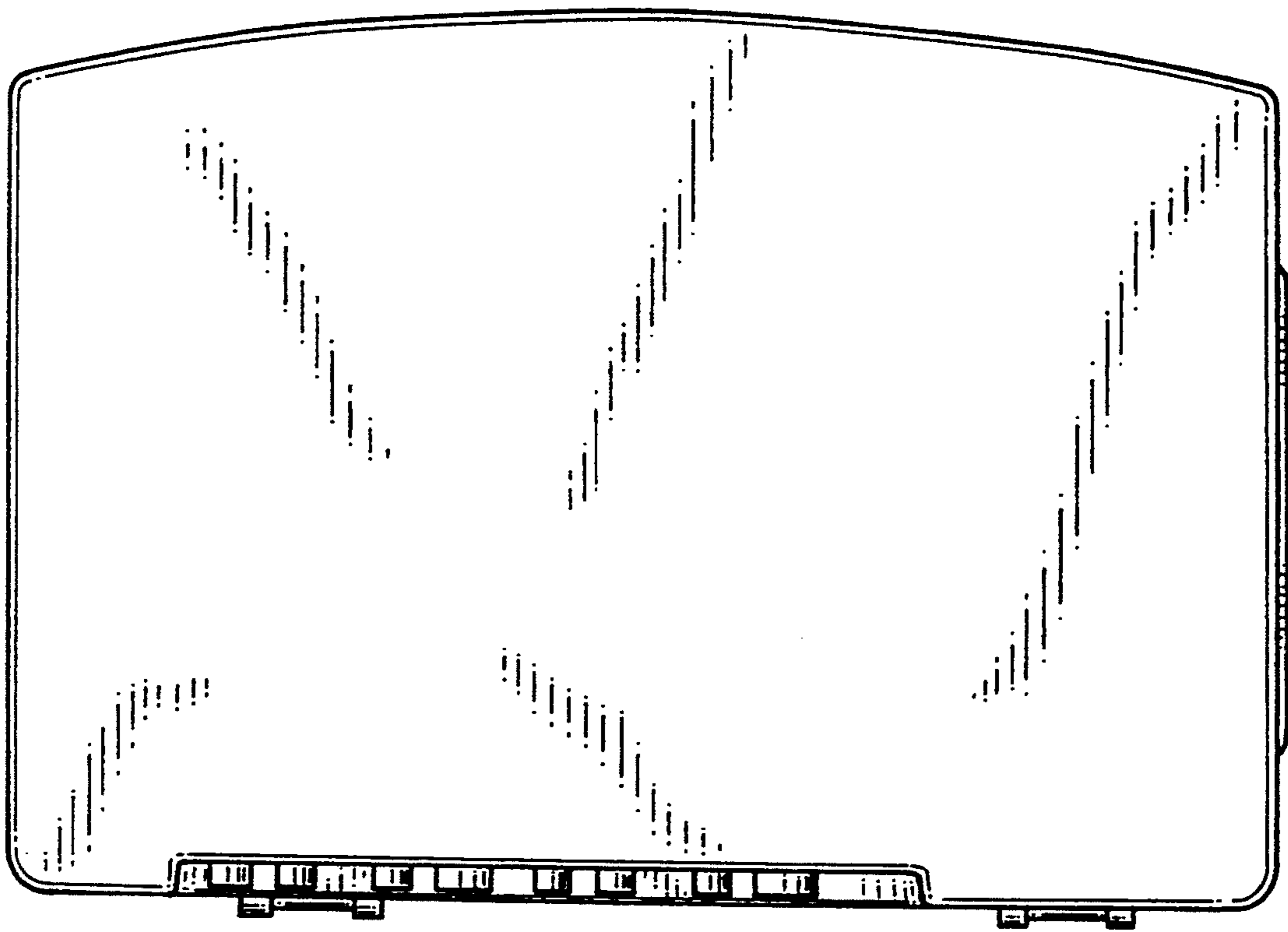

FIG. 6

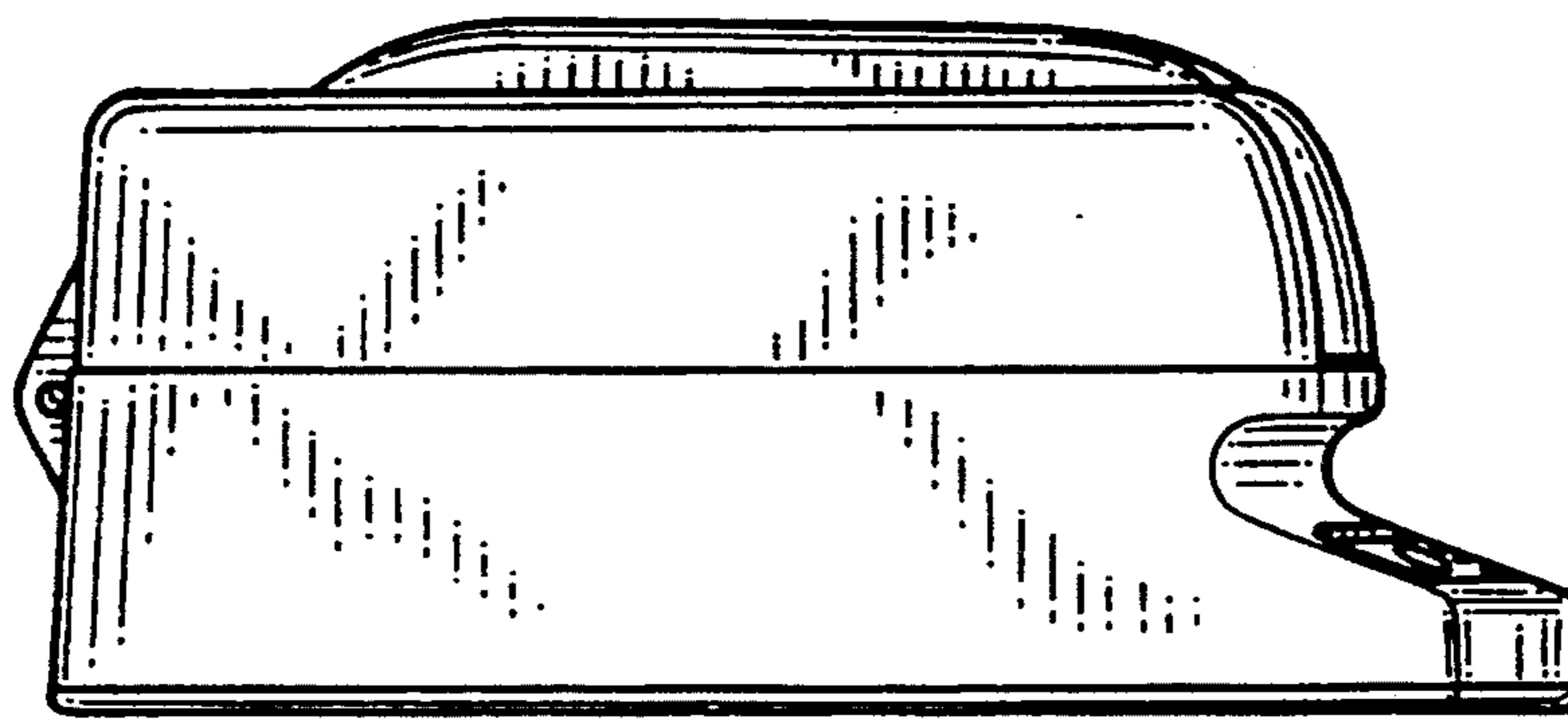
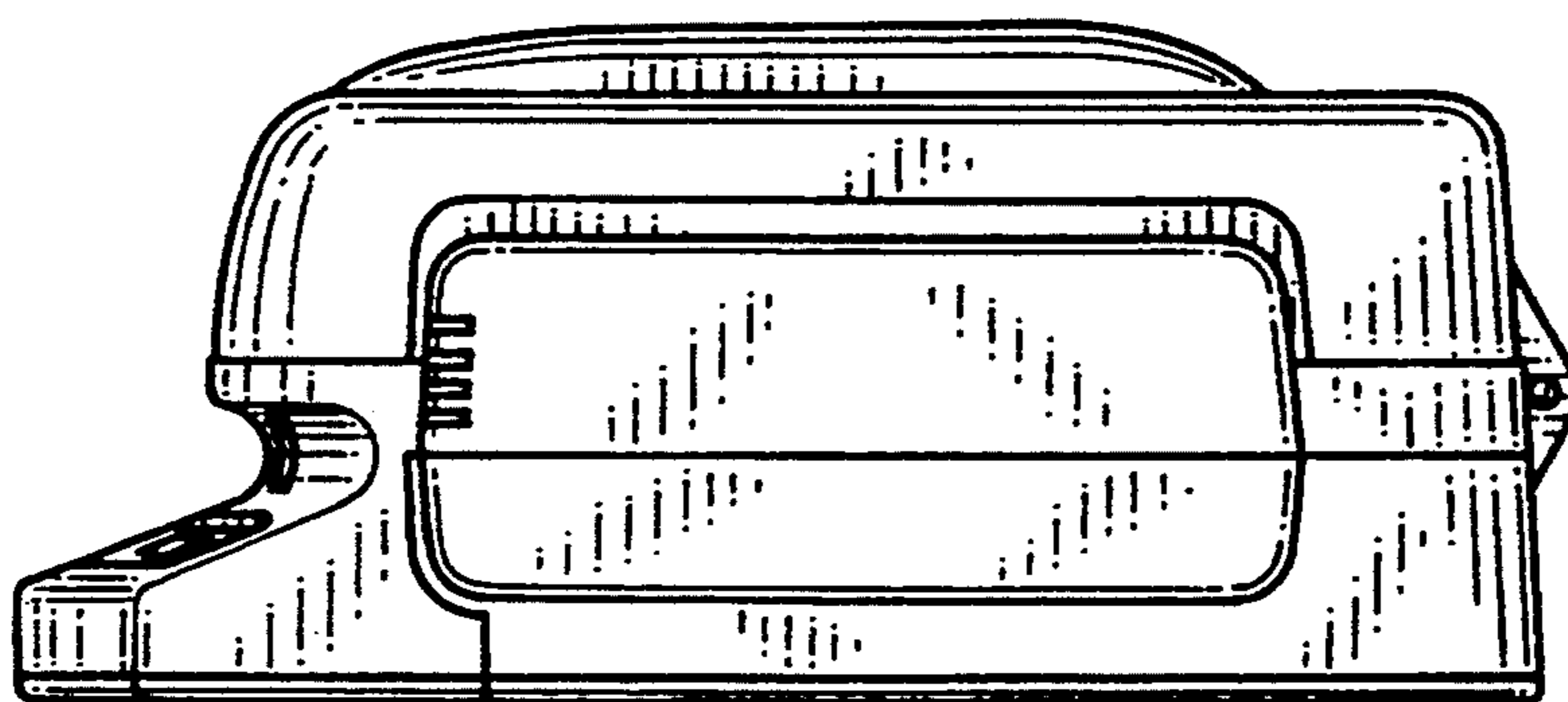

FIG. 7



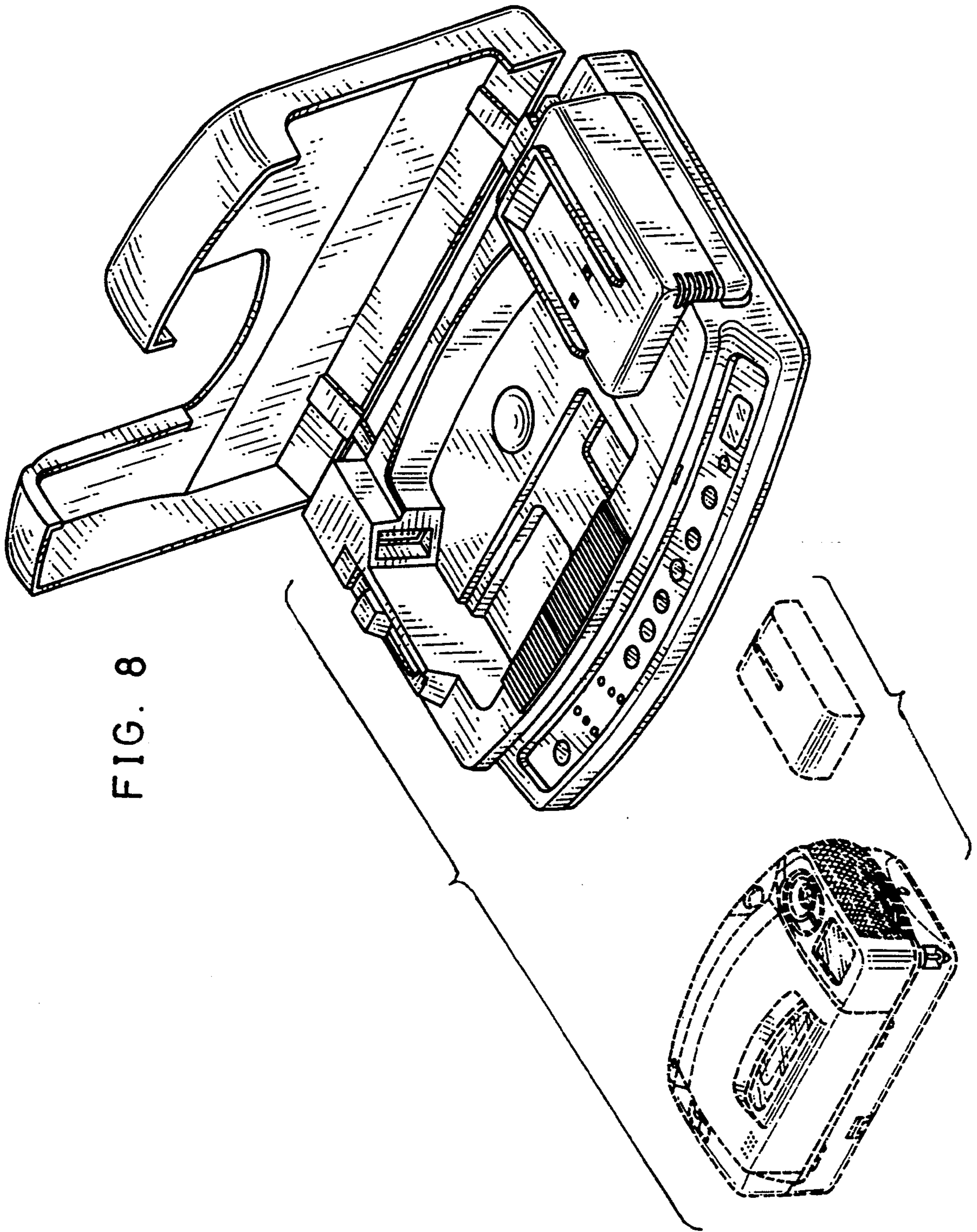

FIG. 8