



US00D355384S

United States Patent [19]

[11] Patent Number: Des. 355,384

Jacquet et al.

[45] Date of Patent: ** Feb. 14, 1995

[54] COMBINED WEIGHING AND DRYING APPARATUS

[75] Inventors: Rémy Jacquet, Le Locle; Yves Marmier, La Chaux-de-Fonds, both of Switzerland

[73] Assignee: Mettler-Toledo AG, Greifensee, Switzerland

[**] Term: 14 Years

[21] Appl. No.: 16,138

[22] Filed: Dec. 8, 1993

[52] U.S. Cl. D10/88; D10/91

[58] Field of Search D10/91, 88; 73/73, 431, 73/433, 865.5; 177/1, 207, 50, 25.11, 25.13, 25.14, 25.17, 238, 239, 240, 245; 209/237, 238, 239, 242, 260, 317, 319, 323, 382, 412; 422/63, 104

[56] **References Cited**

U.S. PATENT DOCUMENTS

4,798,252 1/1989 Knothe et al. 177/245
4,889,201 12/1989 Oldendorf et al. 177/245 X

OTHER PUBLICATIONS

Fisher Scientific IR-100 Moisture Analyzer Denver Instrument Company Nov. 1990.

Primary Examiner—Alan P. Douglas
Assistant Examiner—Antoine D. Davis
Attorney, Agent, or Firm—Laubscher & Laubscher

[57] **CLAIM**

The ornamental design for a combined weighing and drying apparatus, as shown and described.

DESCRIPTION

FIG. 1 is a front right corner perspective view of the combined weighing and drying apparatus in the closed condition;

FIG. 2 is a front elevational view of the apparatus of FIG. 1;

FIG. 3 is a rear elevational view;

FIG. 4 is a right side elevational view;

FIG. 5 is a left side elevational view;

FIG. 6 is a top plan view;

FIG. 7 is a bottom plan view;

FIG. 8 is a front right perspective view of the apparatus of FIG. 1 in the open condition;

FIG. 9 is an enlarged fragmentary perspective view showing a detail of the apparatus of FIG. 1; and,

FIG. 10 is a sectional view taken along line 10—10 of FIG. 9.

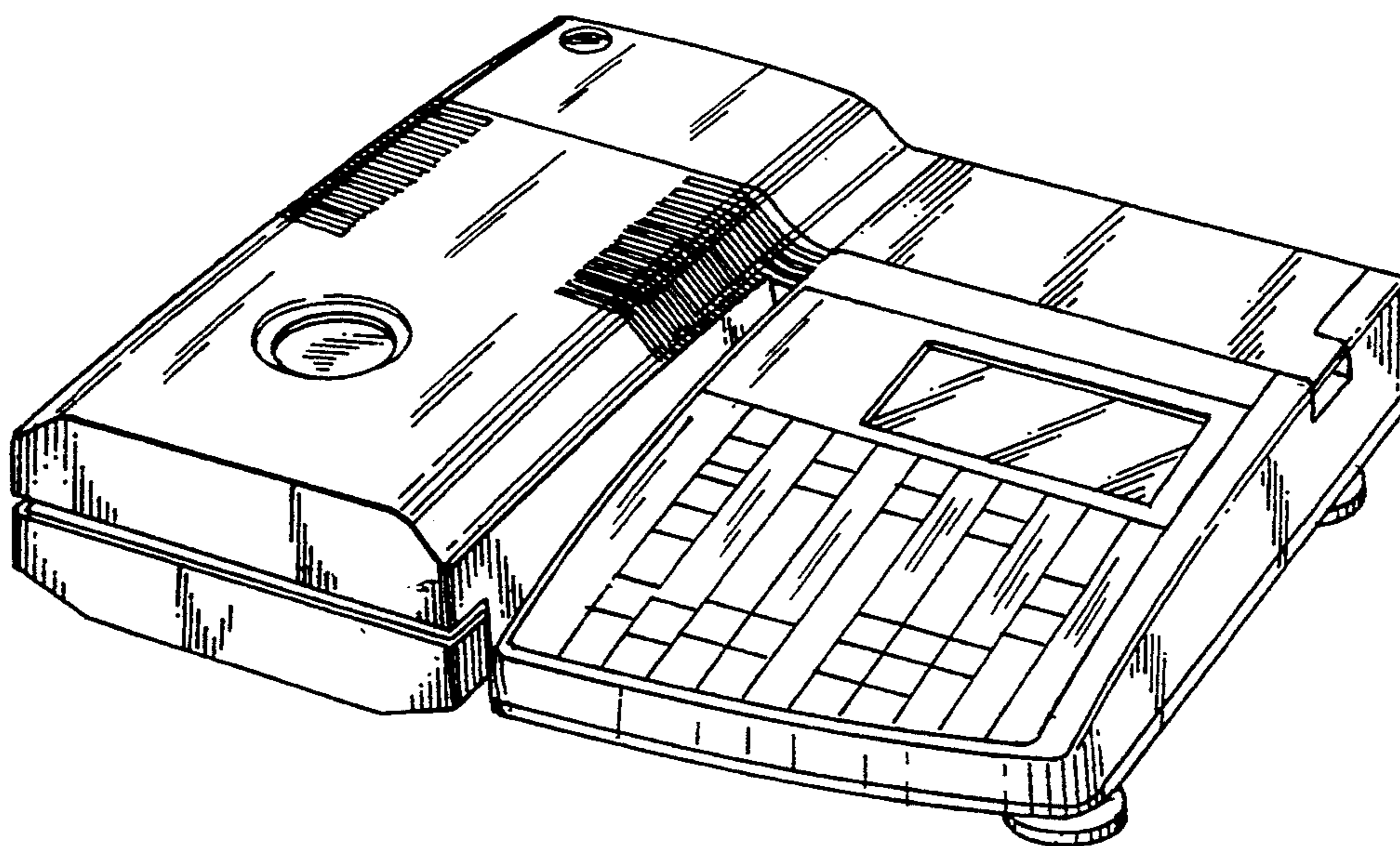

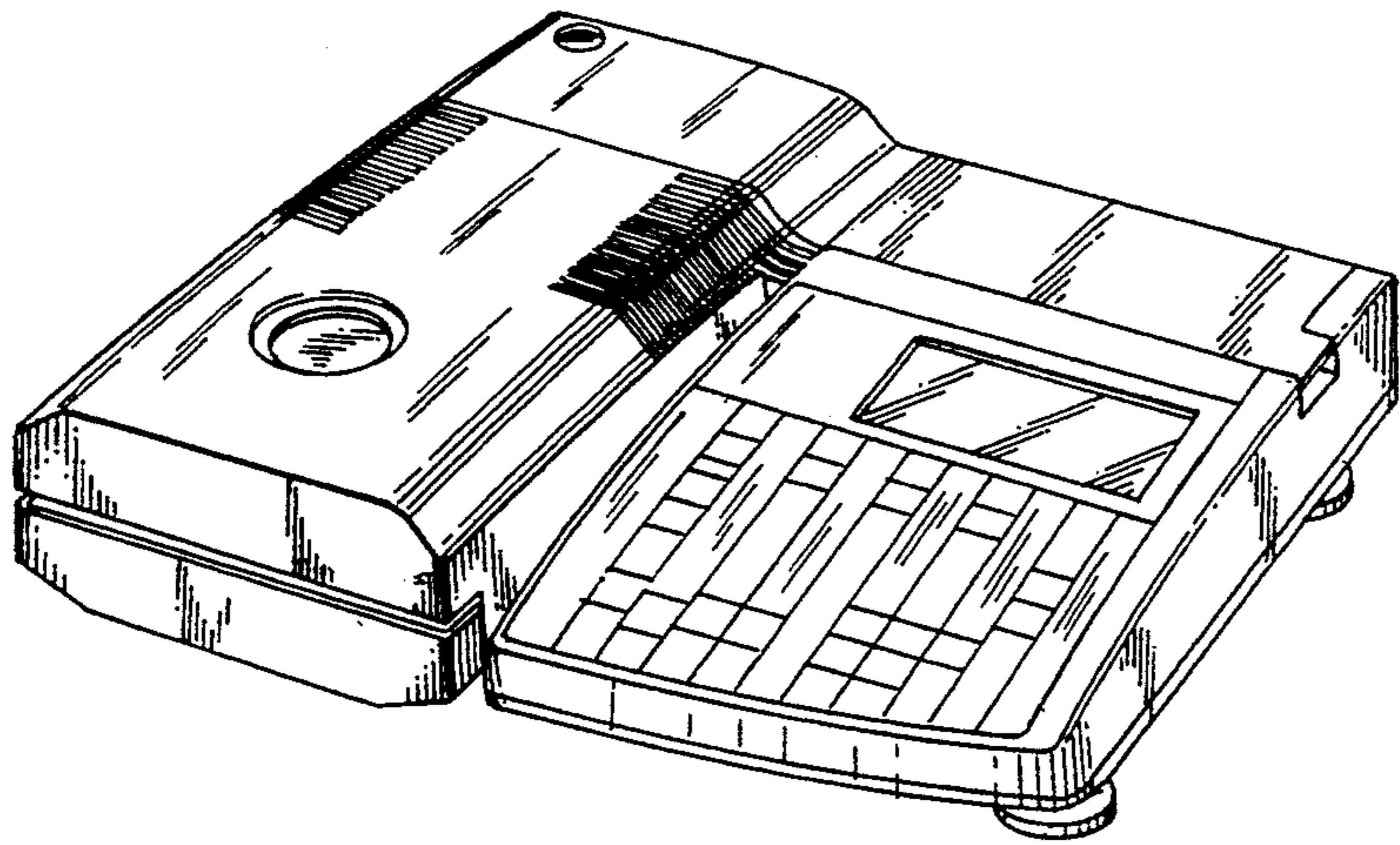

FIG. 1

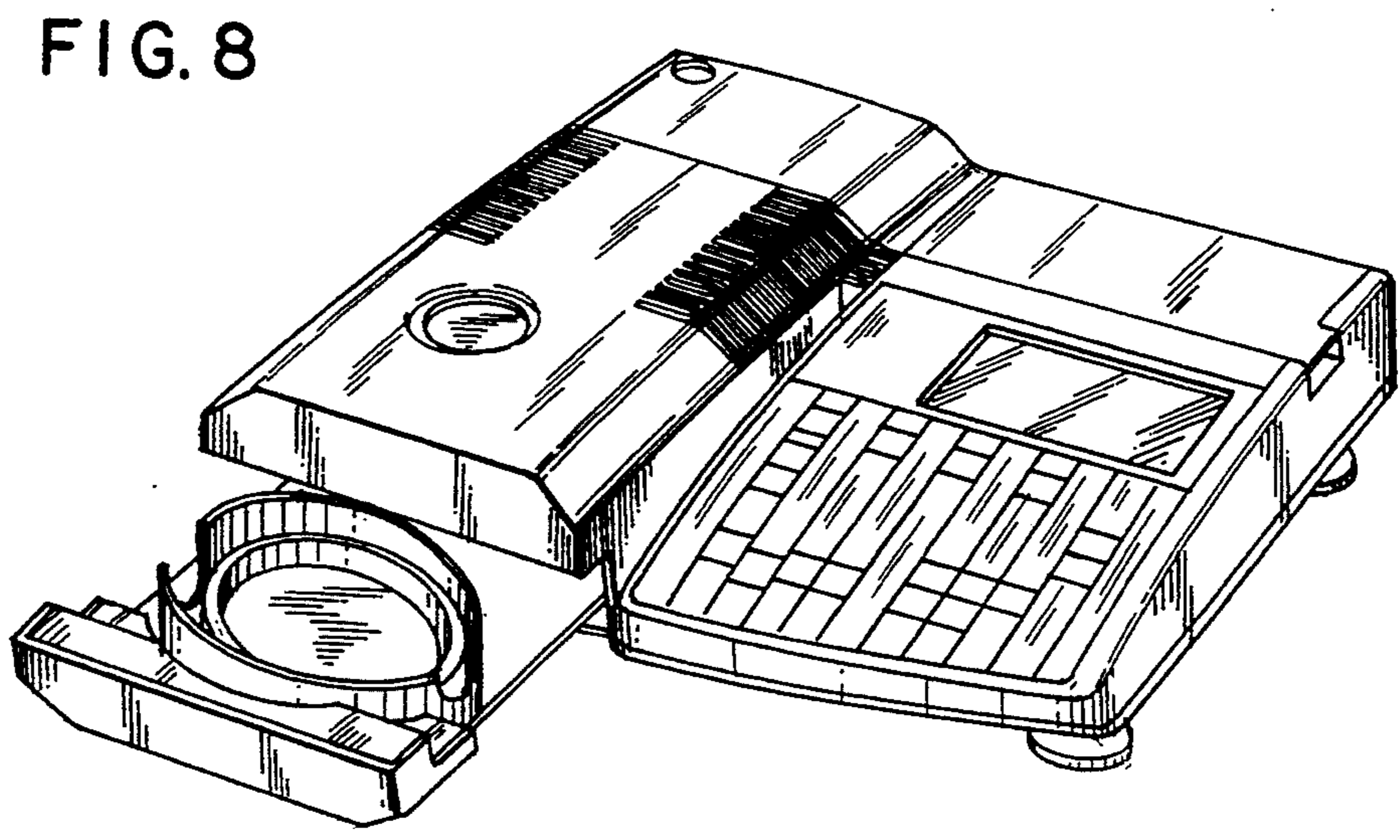

FIG. 8

FIG. 2

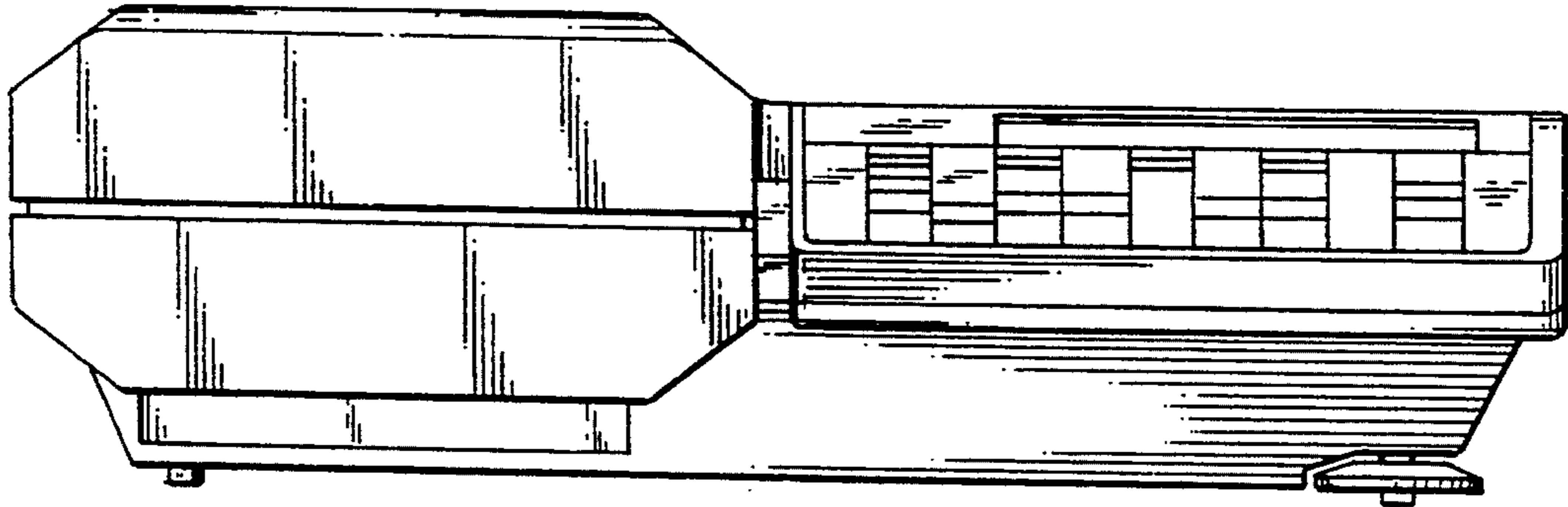

FIG. 3

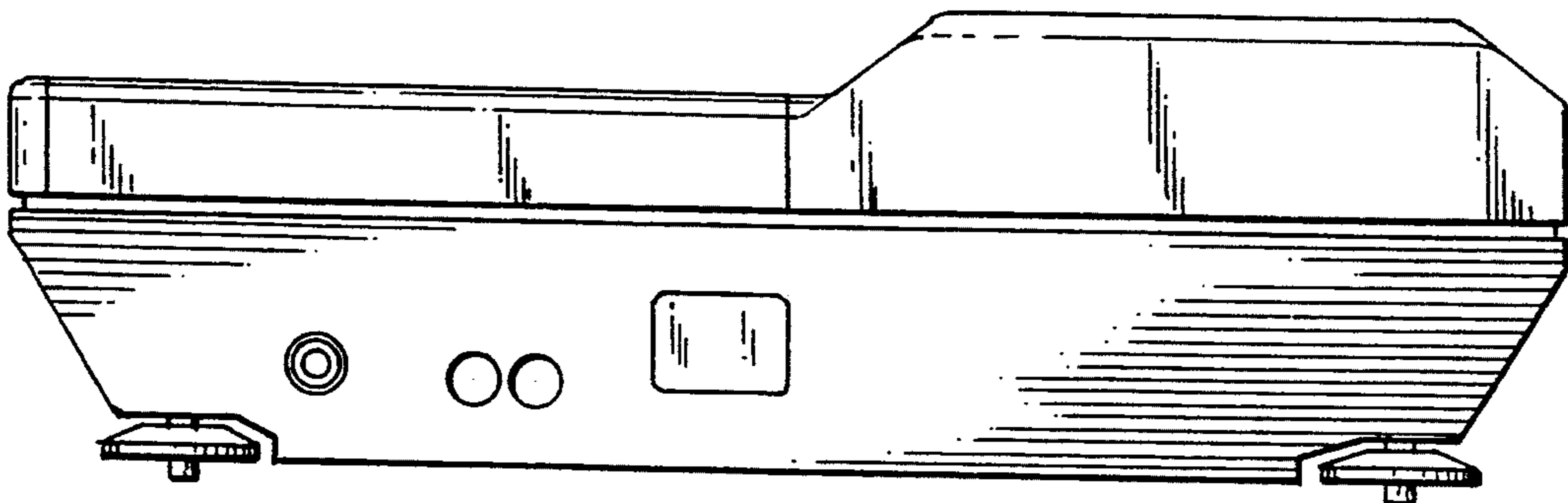

FIG. 4

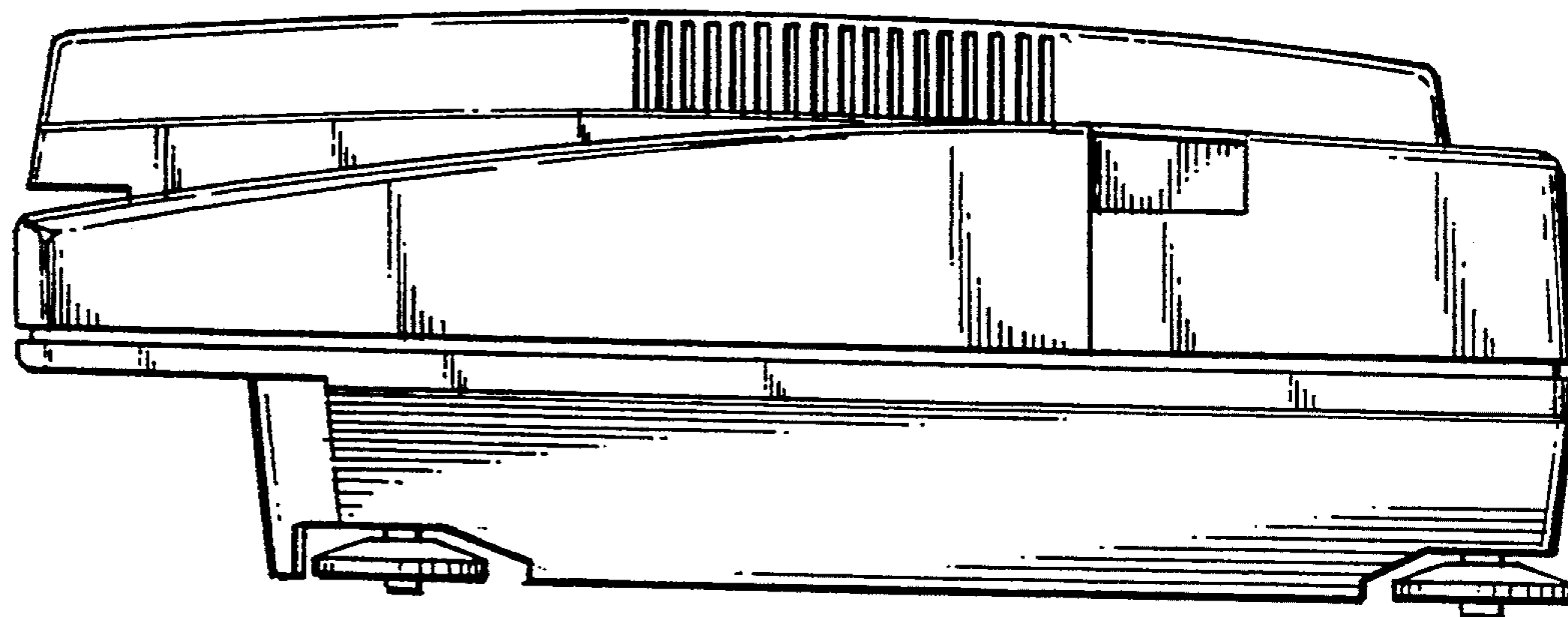

FIG. 5

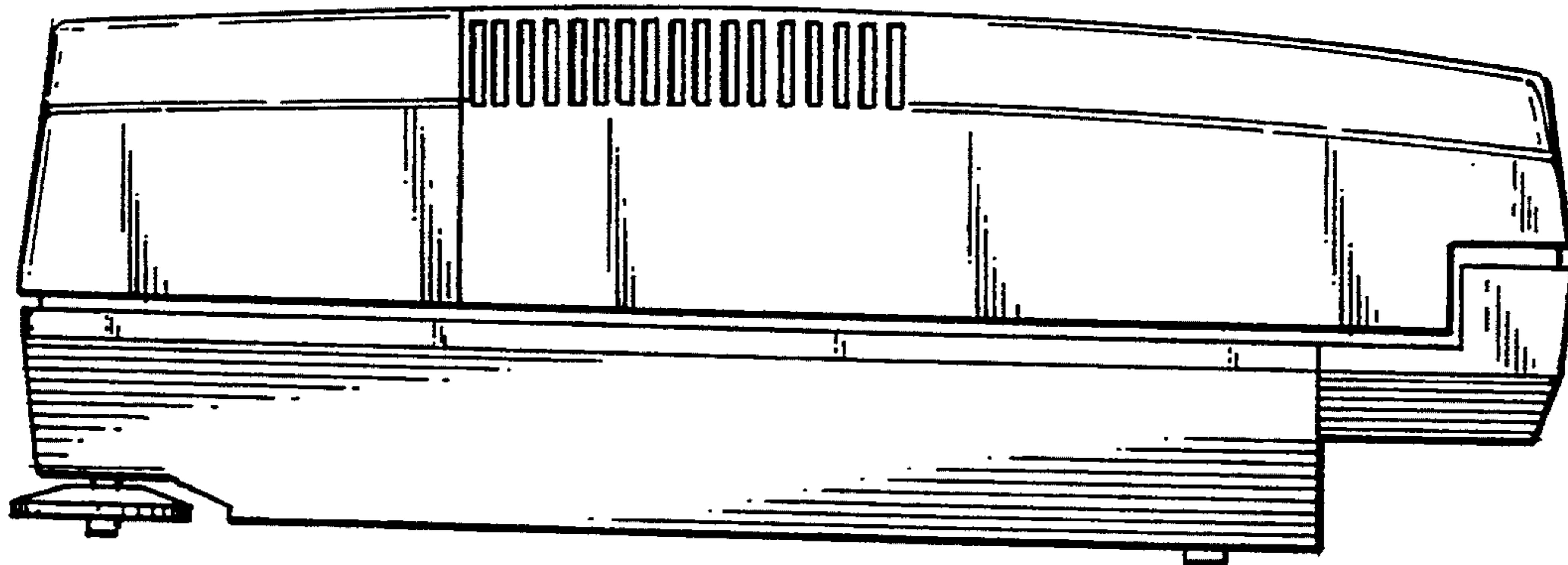

FIG. 6

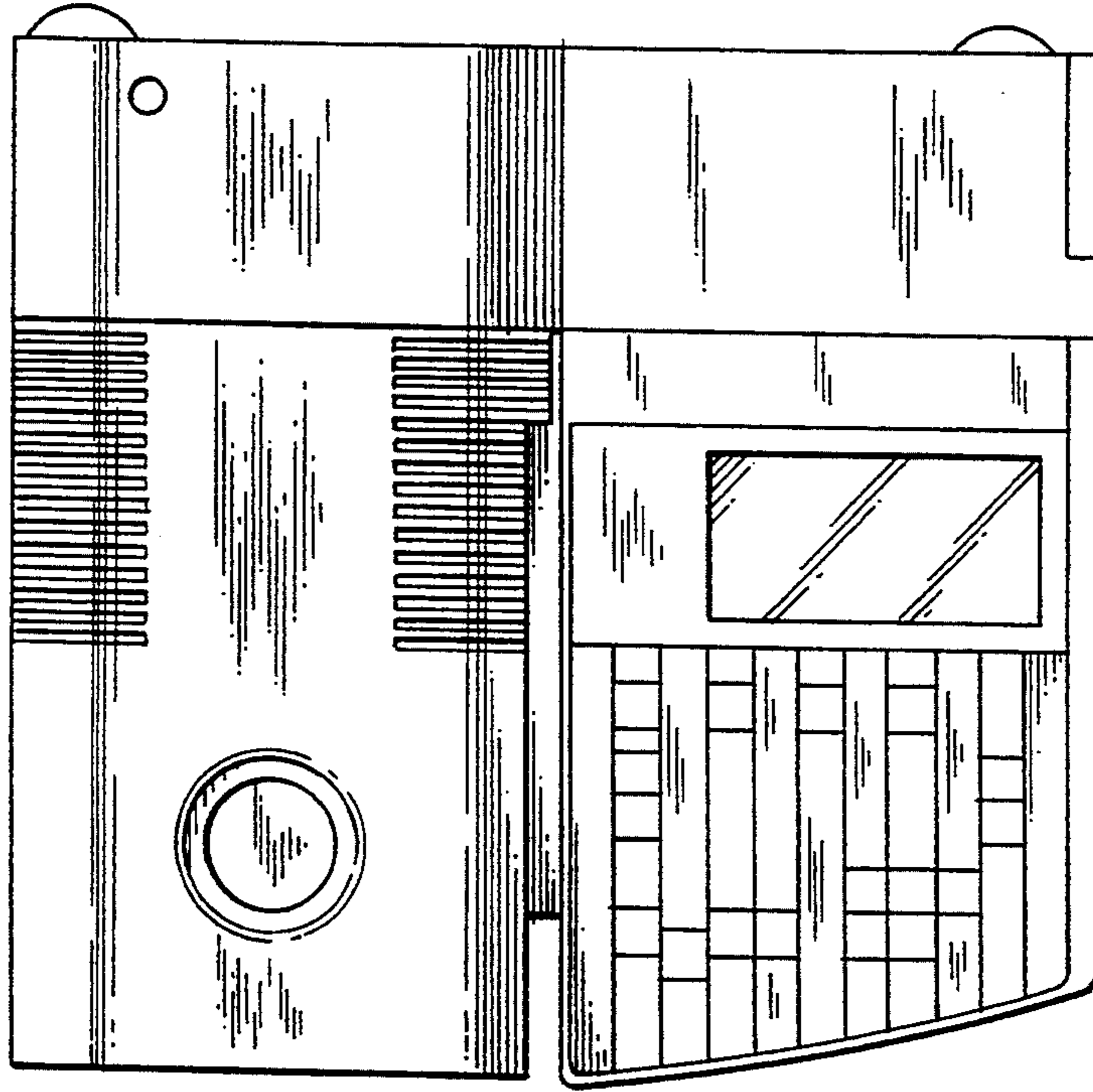

FIG. 7

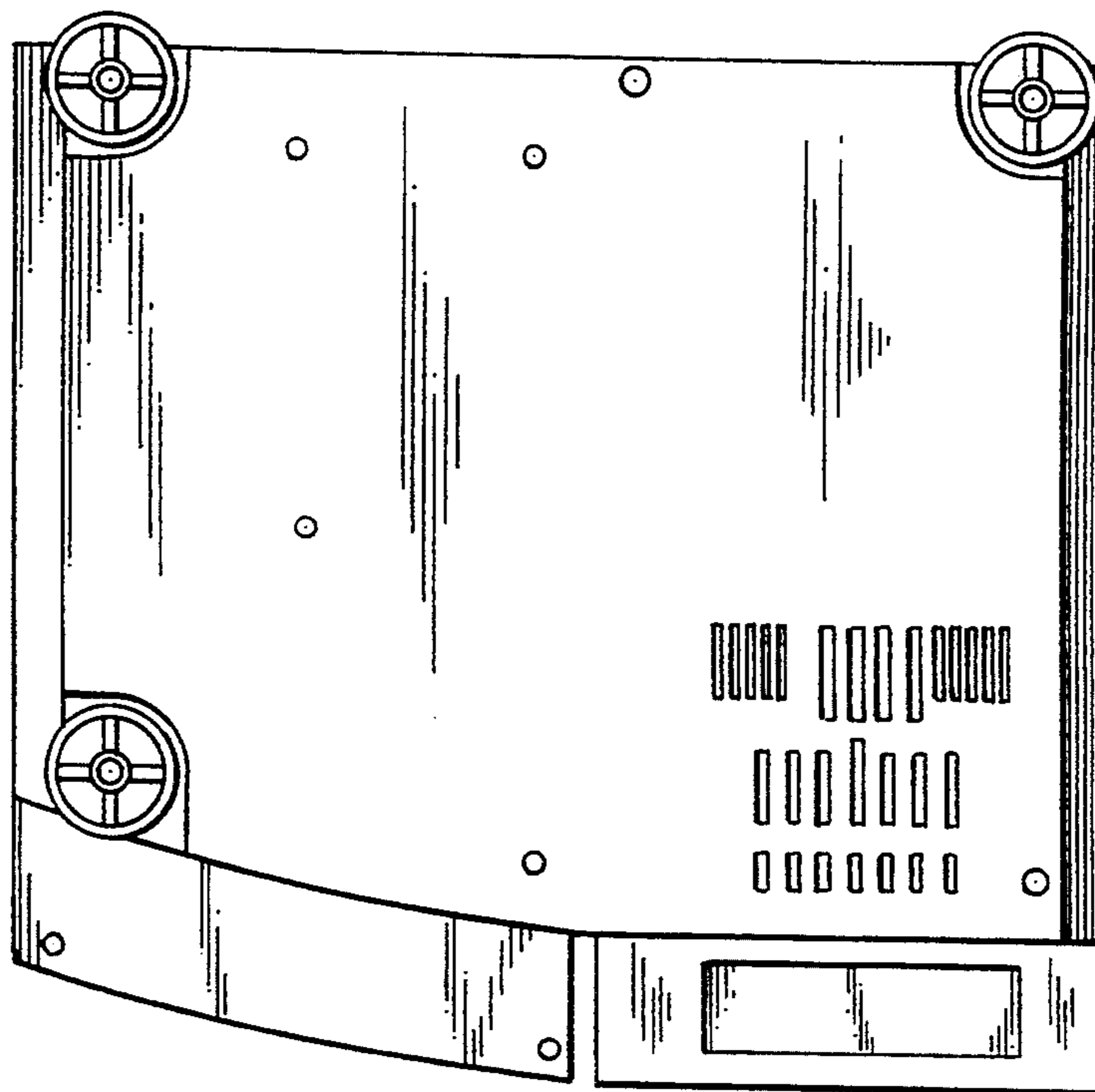

FIG. 9

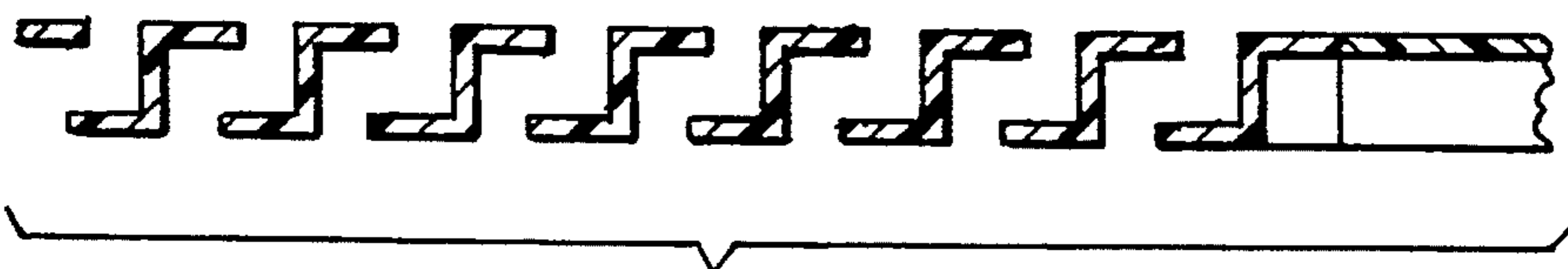
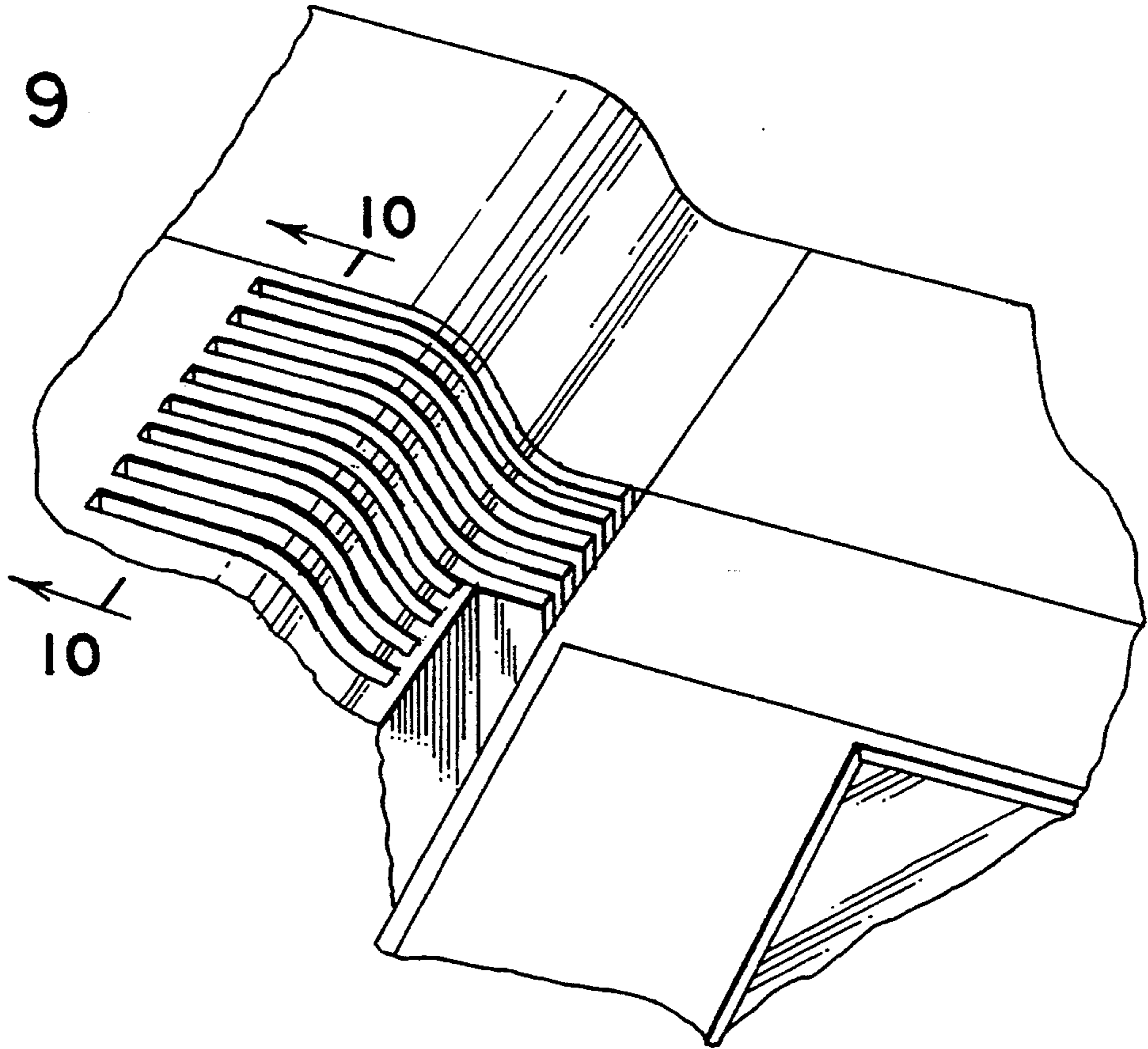

FIG. 10