



US00D355254S

United States Patent [19]

Krafft et al.

[11] Patent Number: **Des. 355,254**

[45] Date of Patent: **** Feb. 7, 1995**

[54] BONE CUTTING GUIDE

[75] Inventors: **Petrus Krafft, Warsaw; Verlon C. Caldwell, Jr., Peru, both of Ind.**

[73] Assignee: **Zimmer, Inc., Warsaw, Ind.**

[**] Term: **14 Years**

[21] Appl. No.: **14,729**

[22] Filed: **Oct. 29, 1993**

[52] U.S. Cl. **D24/140; D10/64; D15/133**

[58] Field of Search **D24/140, 146; D10/64, D10/65; D15/133; 606/82, 87, 79, 86, 88, 89; 33/511, 512, 562, 566**

[56] References Cited

U.S. PATENT DOCUMENTS

D. 230,098	1/1974	Rylee	D24/140
4,703,751	11/1987	Pohl	D24/140 X
4,722,330	2/1988	Russell et al.	606/88
5,053,037	10/1991	Lackey	606/79
5,053,039	10/1991	Hofmann et al.	606/86 X
5,100,408	3/1992	Lackey	606/79
5,122,144	6/1992	Bert et al.	606/87 X
5,129,909	7/1992	Sutherland	606/86 X
5,176,685	1/1993	Raghack	606/82 X

5,246,444 9/1993 Schreiber 606/87

Primary Examiner—A. Hugo Word
Assistant Examiner—I. Simmons
Attorney, Agent, or Firm—Todd A. Dawson

[57] CLAIM

The ornamental designs of a bone cutting guide, as shown and described.

DESCRIPTION

FIG. 1 is a perspective view of a bone cutting guide showing our new design;
FIG. 2 is a rear elevational view thereof;
FIG. 3 is a left side elevational view thereof;
FIG. 4 is a bottom view thereof;
FIG. 5 is a front elevational view thereof;
FIG. 6 is a top view thereof;
FIG. 7 is a right side elevational view thereof;
FIG. 8 is a perspective view of a bone cutting guide showing a second embodiment of our new design;
FIG. 9 is a rear elevational view thereof;
FIG. 10 is a left side elevational view thereof;
FIG. 11 is a bottom view thereof;
FIG. 12 is a front elevational view thereof;
FIG. 13 is a top view thereof; and,
FIG. 14 is a right side elevational view thereof.

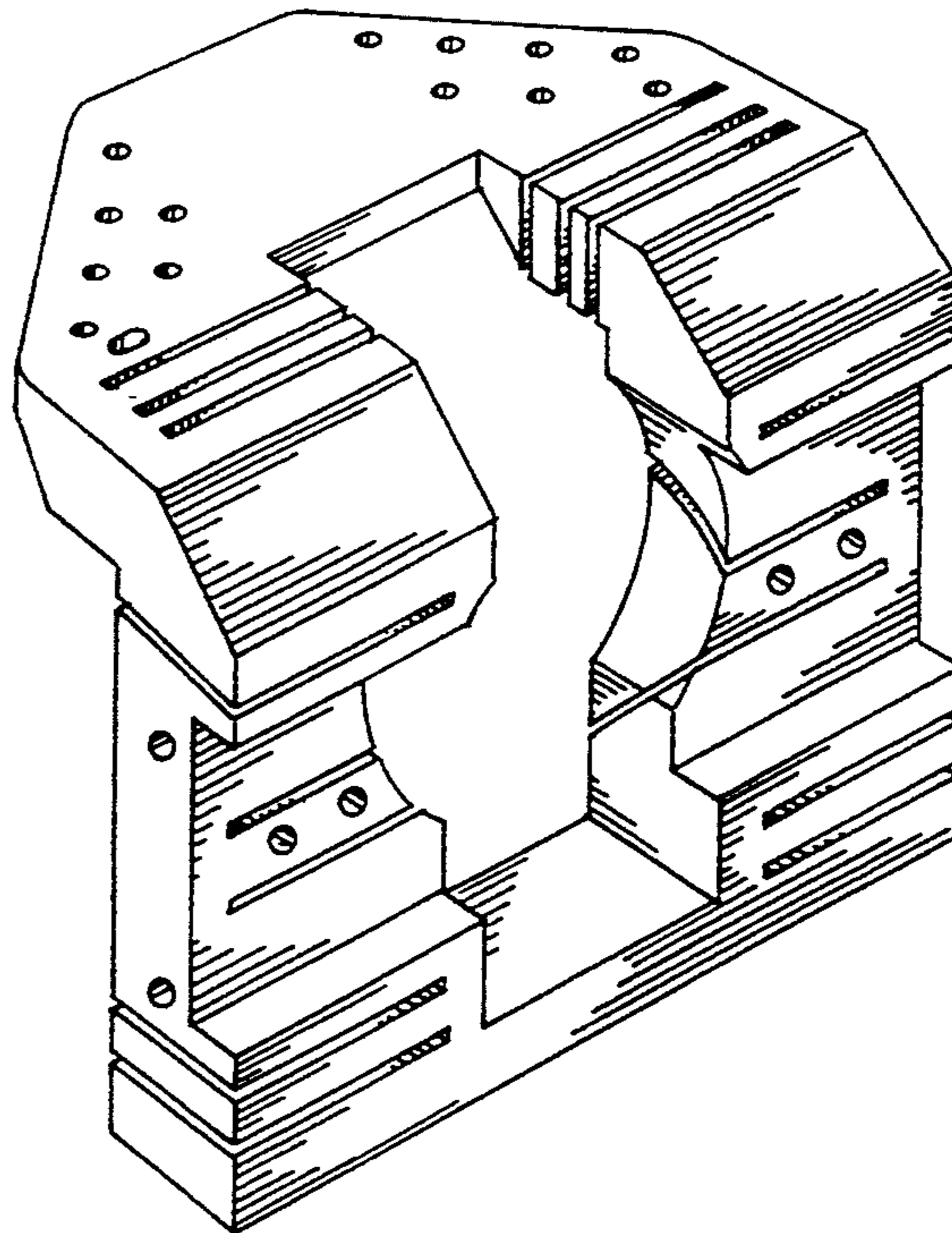
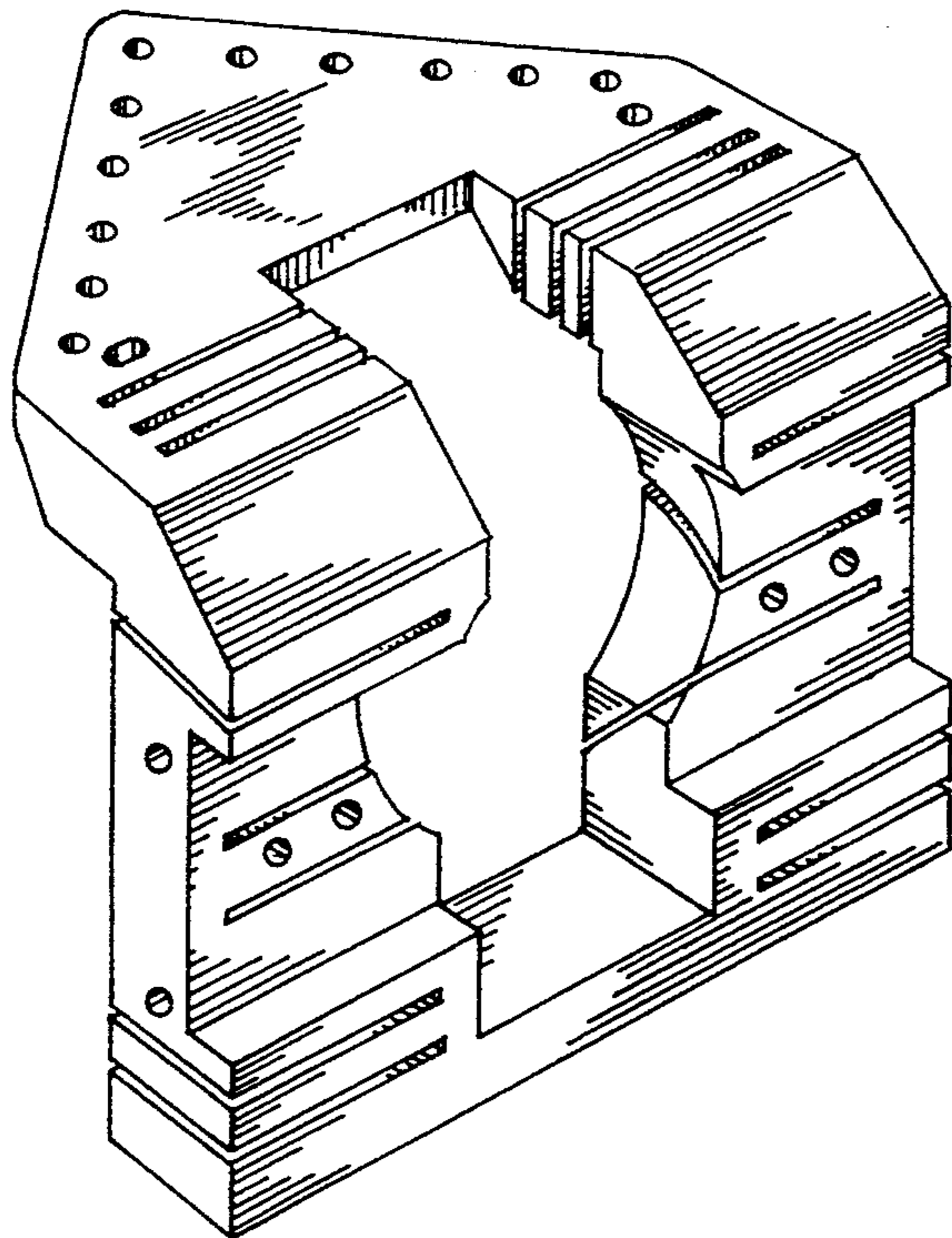

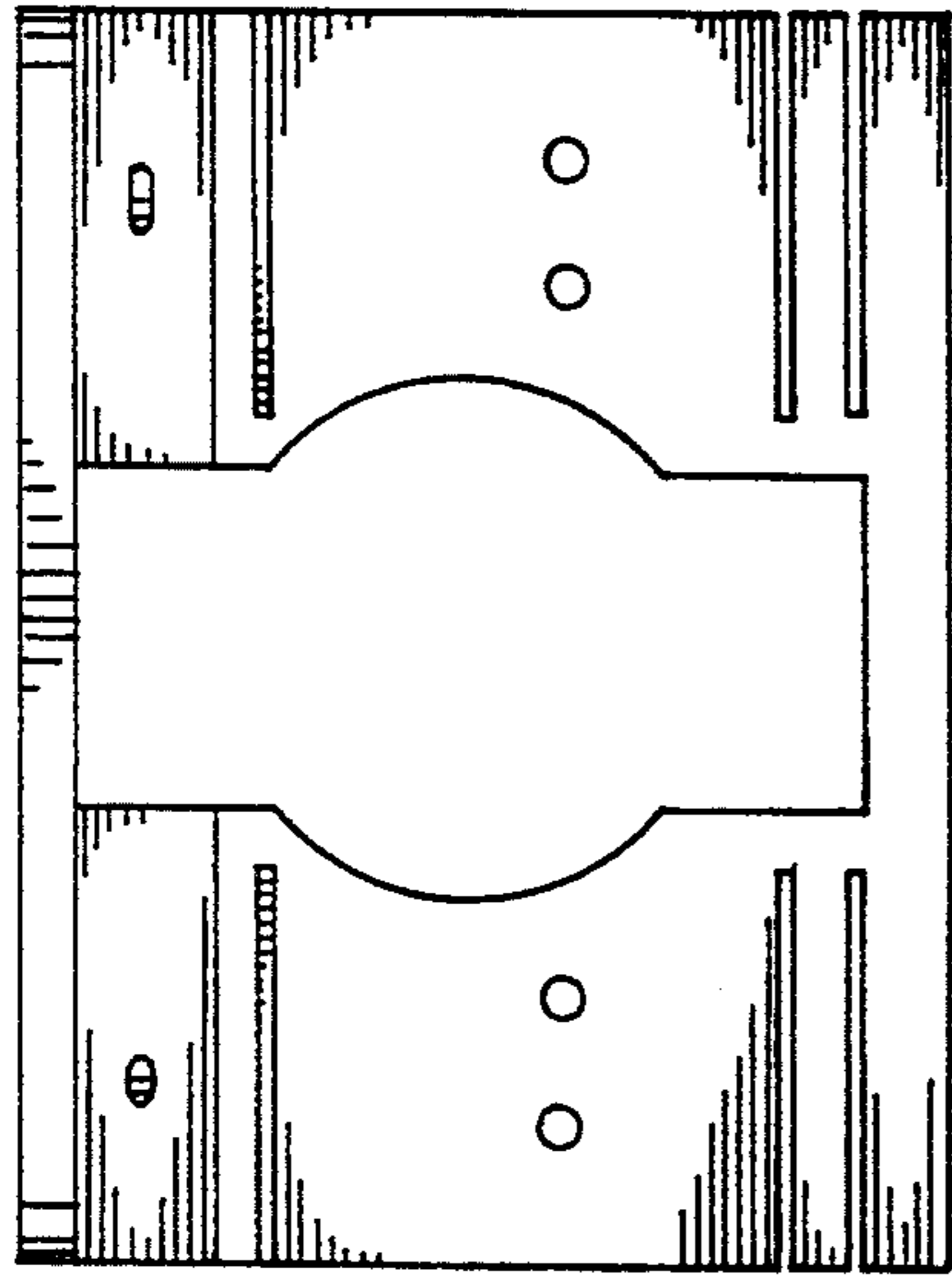

FIG. 2

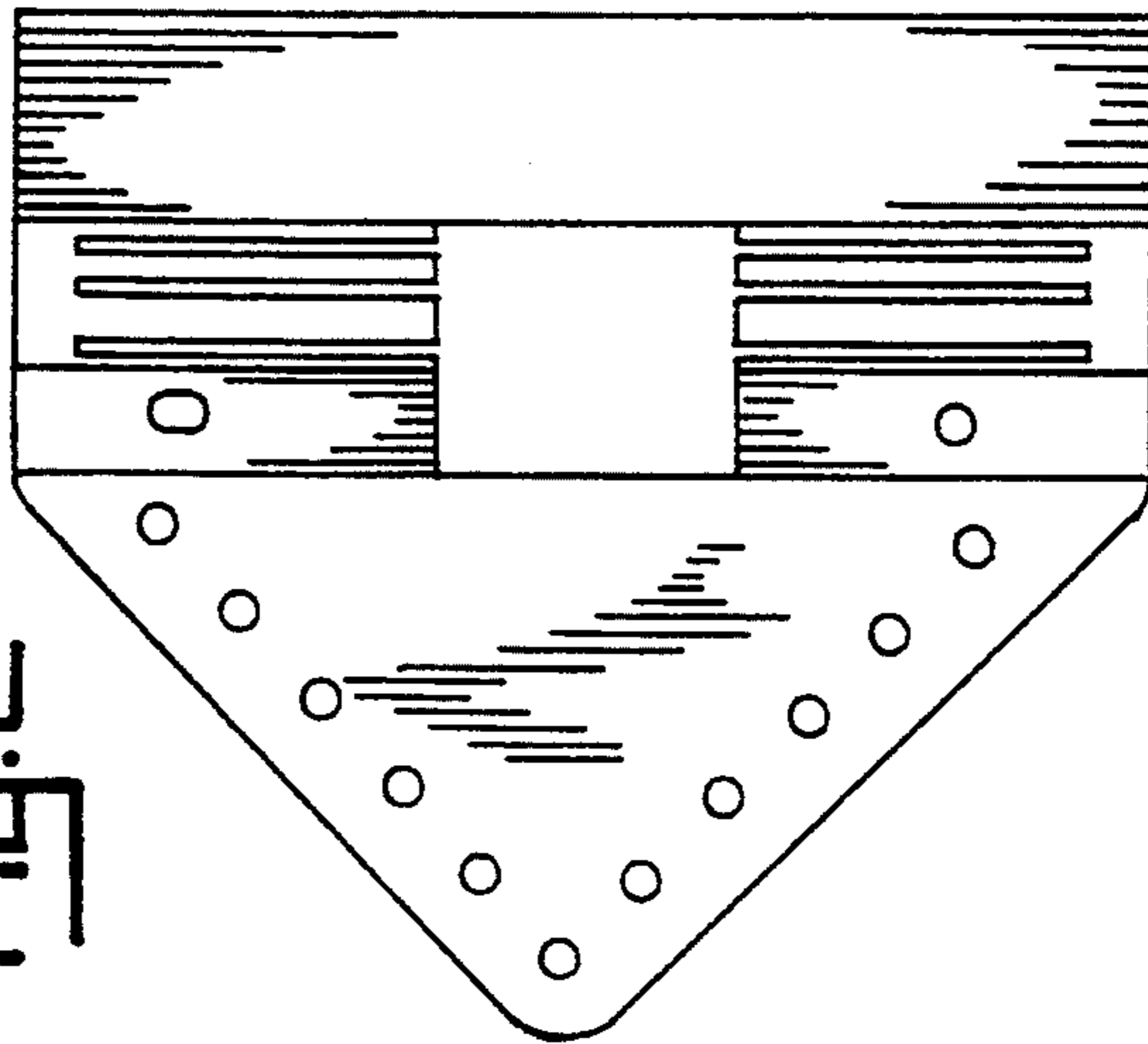

FIG. 4

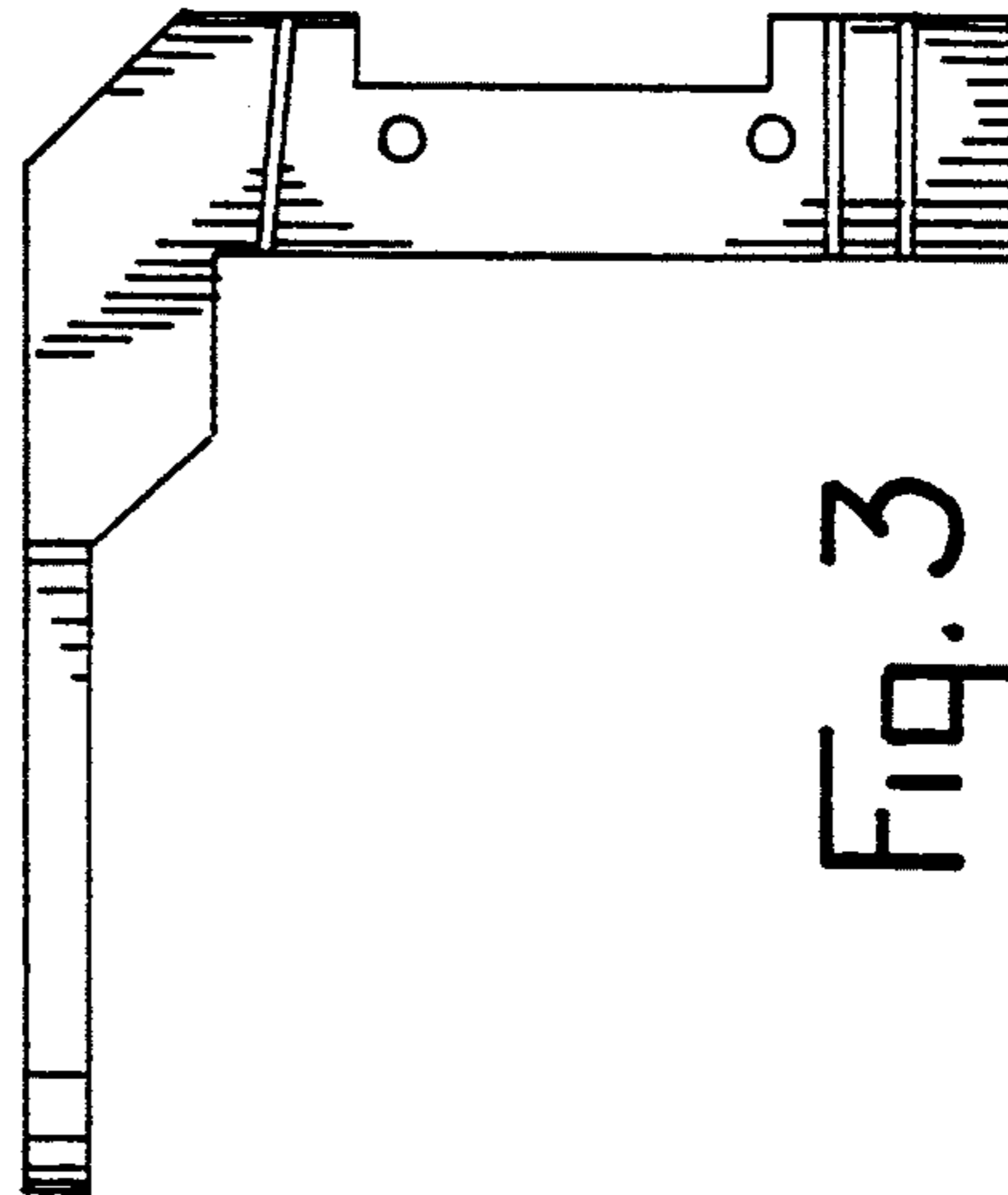

FIG. 3

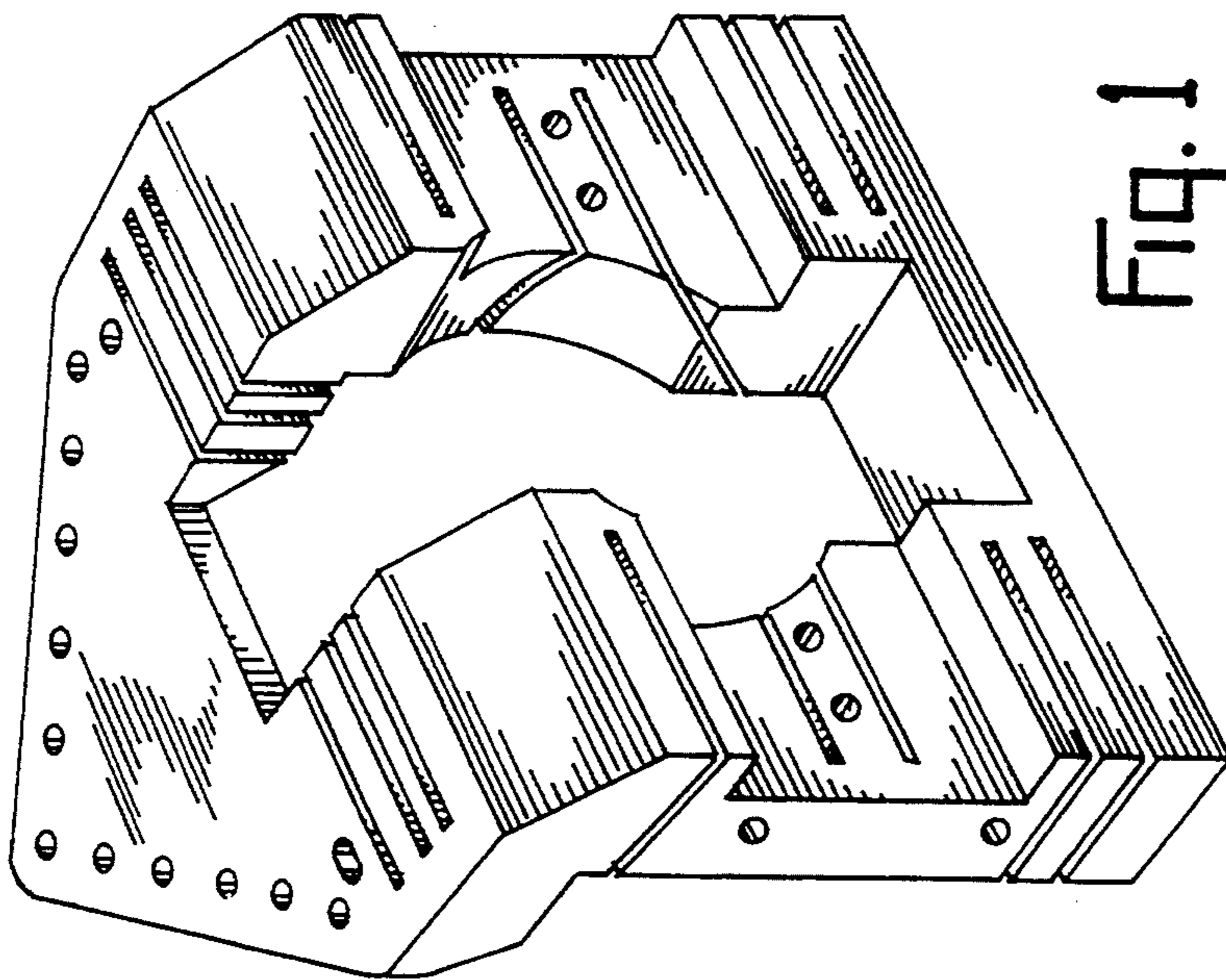

FIG. 1

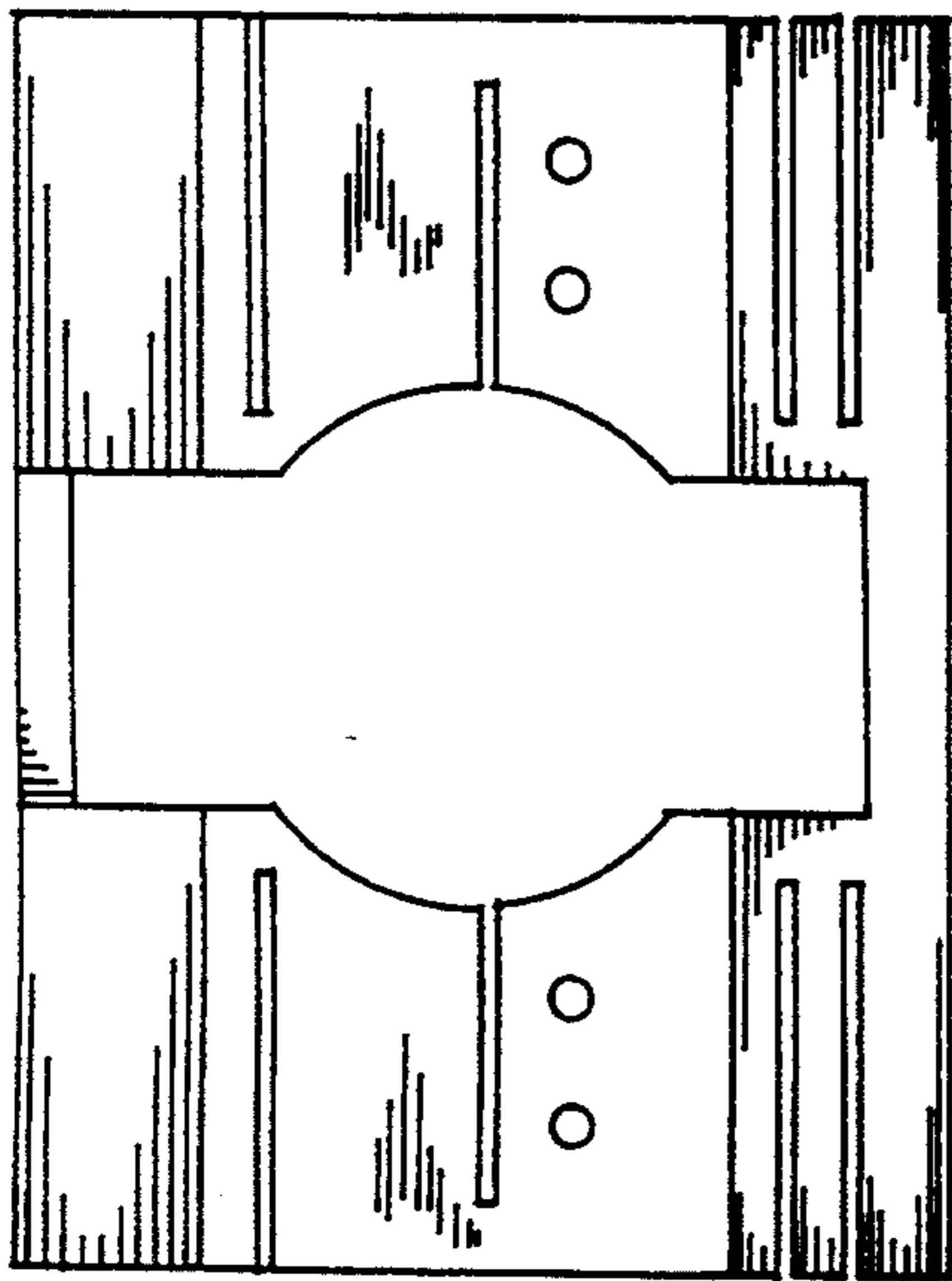

FIG. 5

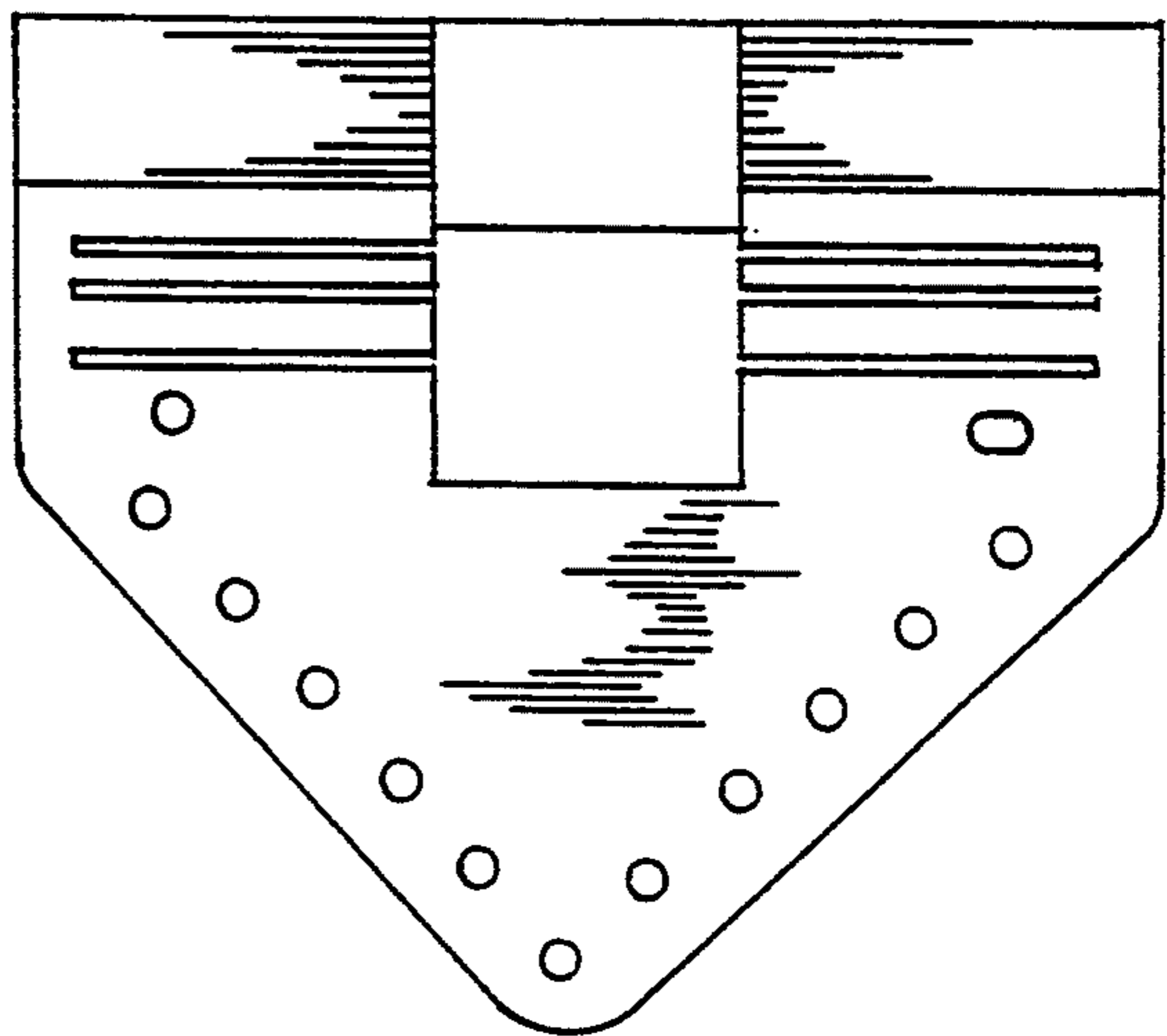

FIG. 6

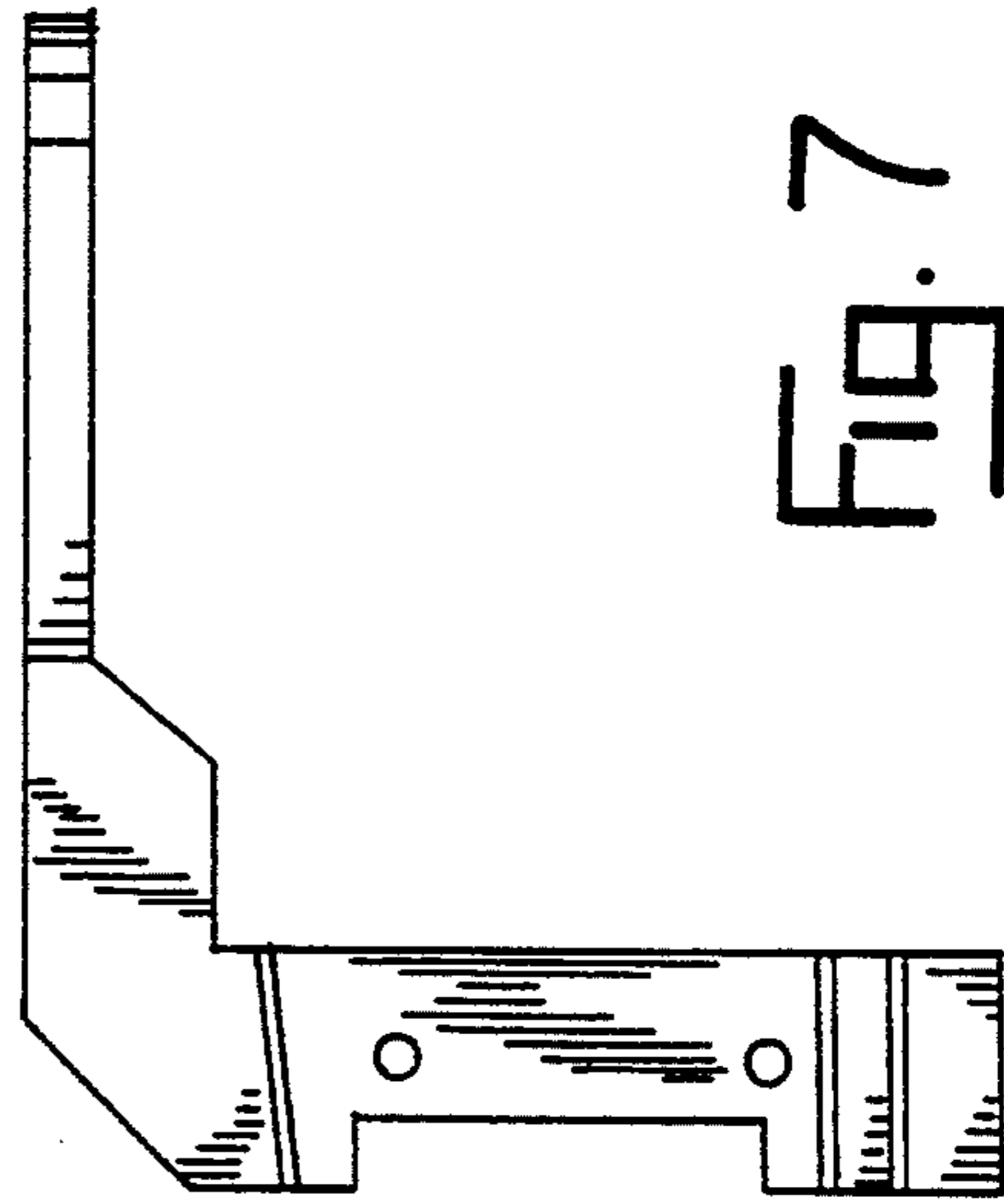

FIG. 7

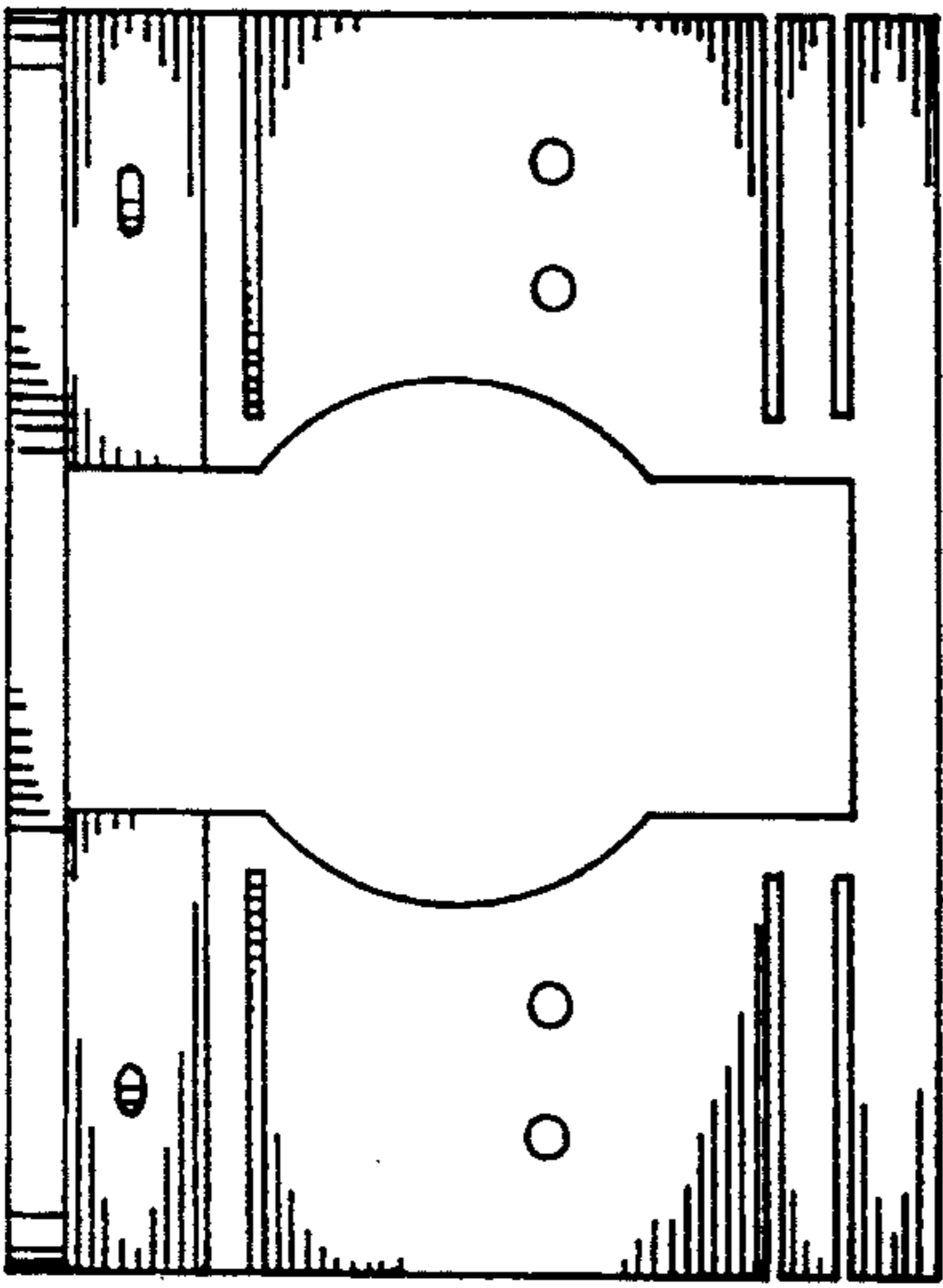

FIG. 9

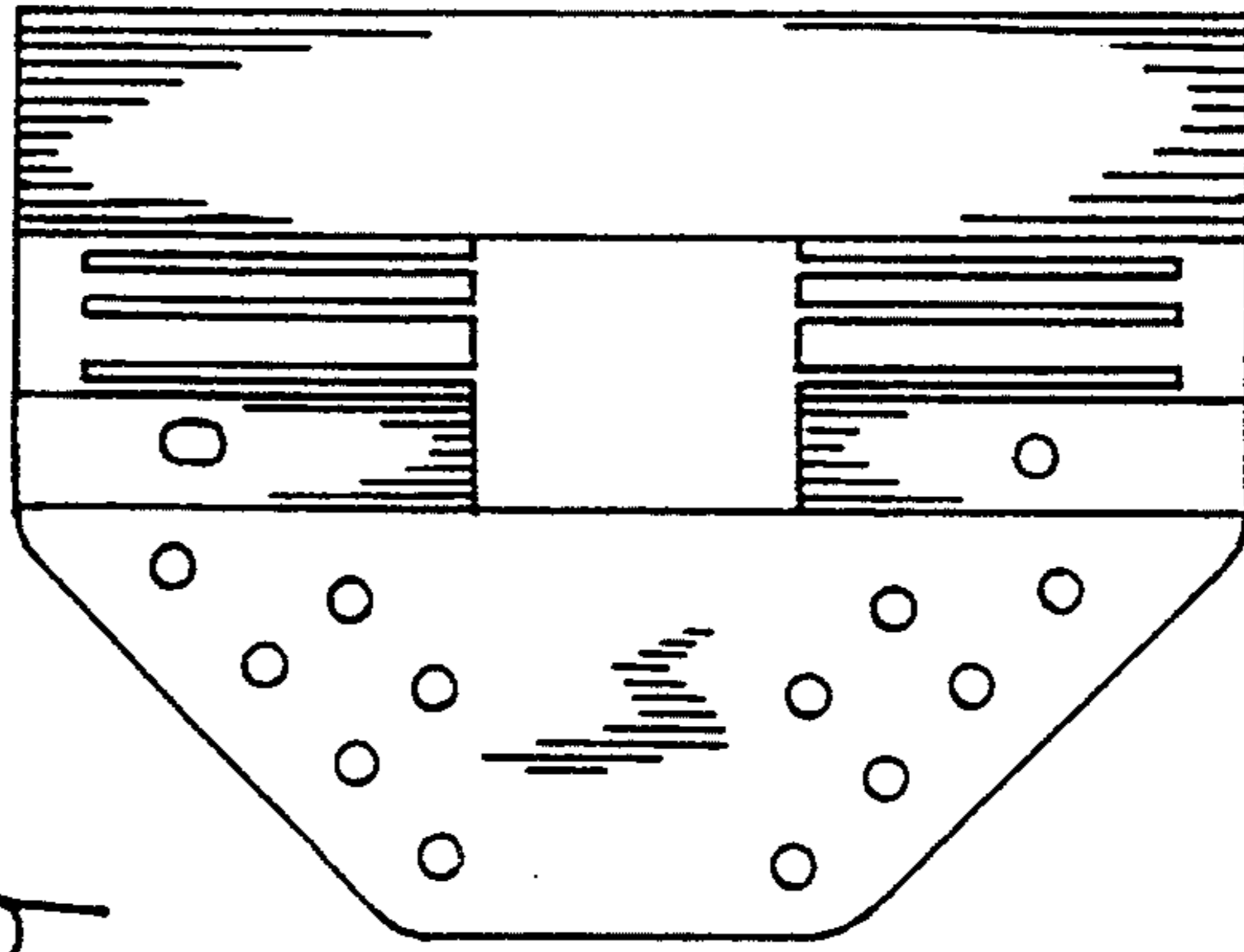

FIG. 11

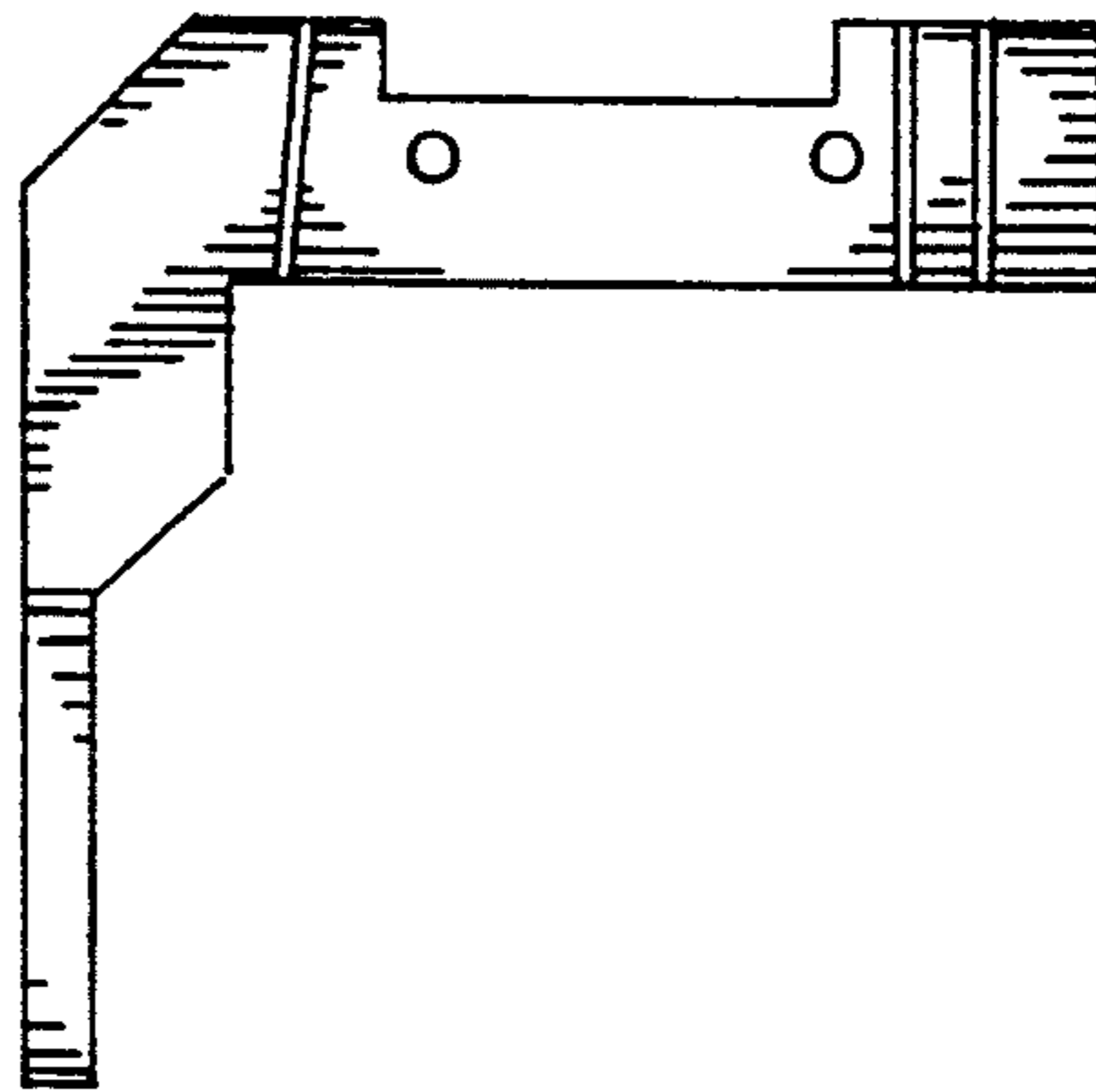

FIG. 10

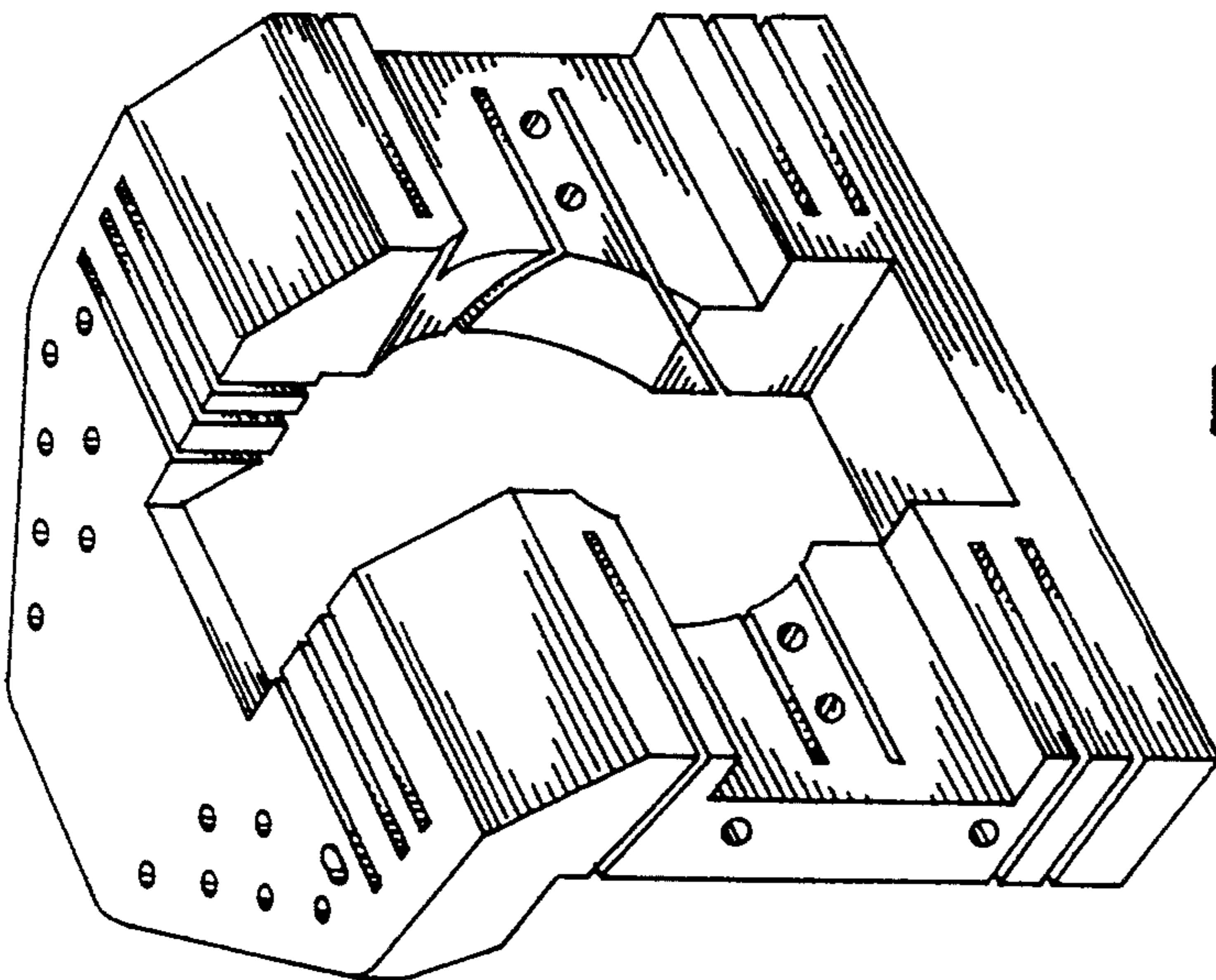

FIG. 8

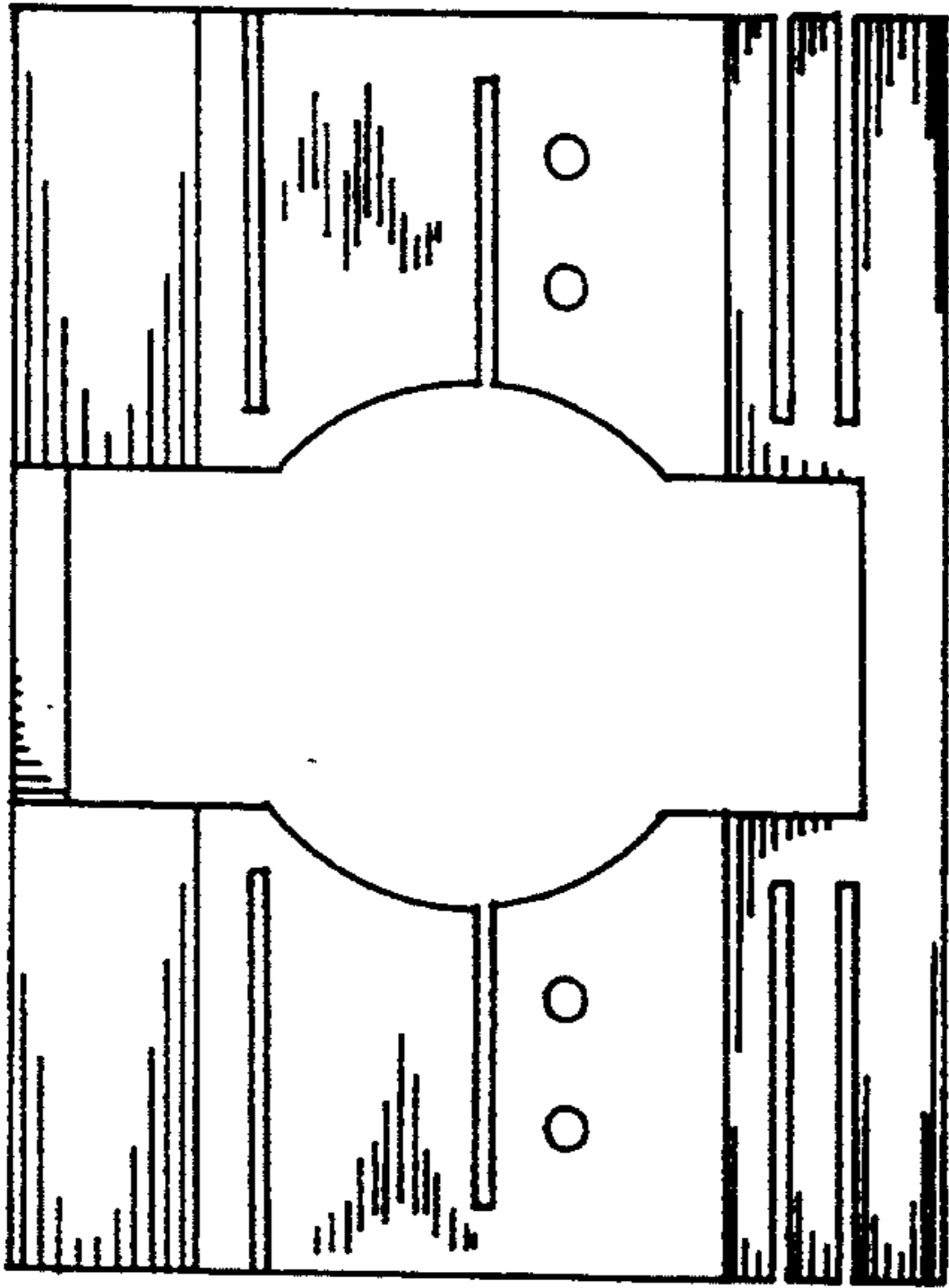

FIG. 12

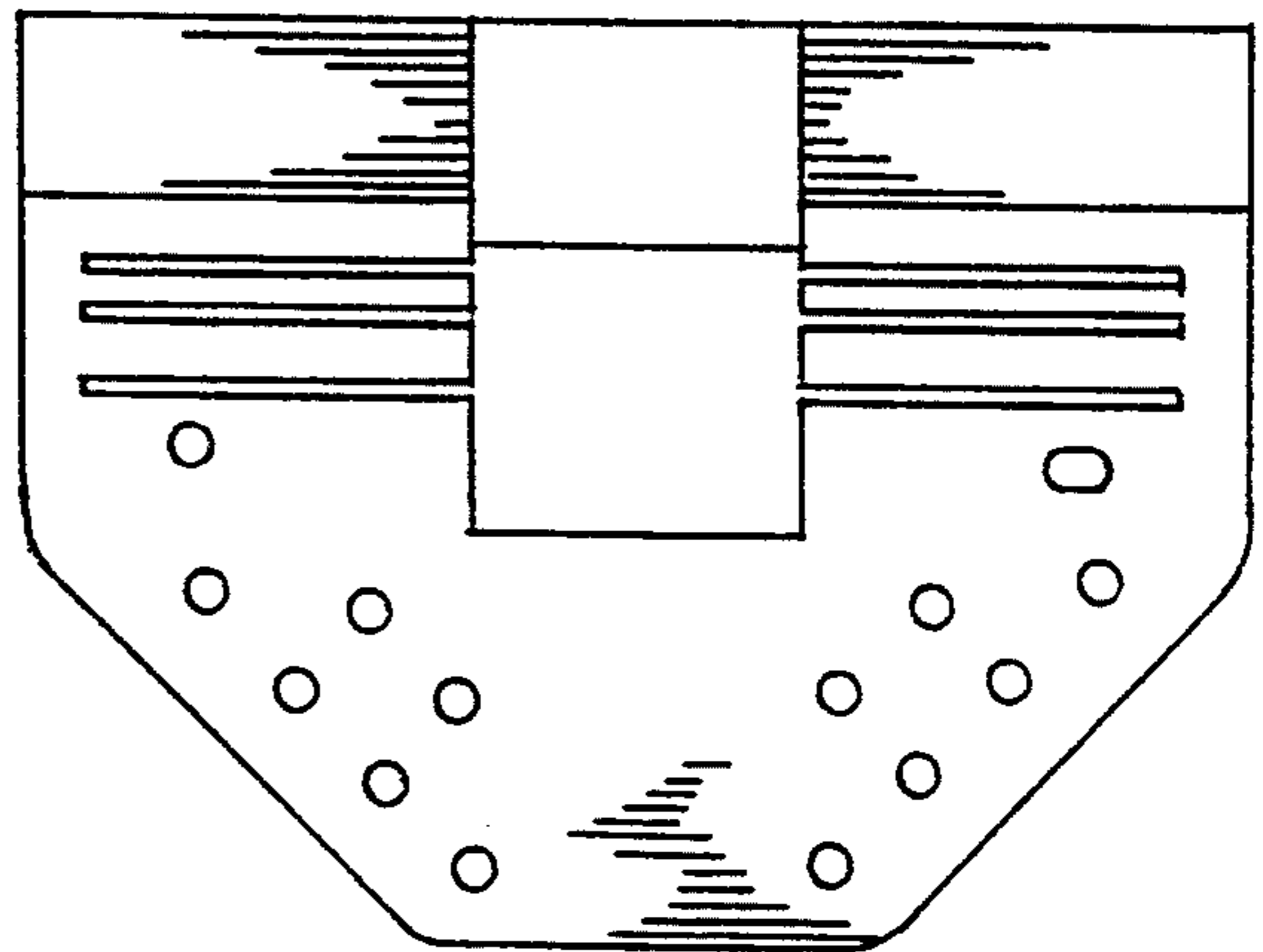

FIG. 13

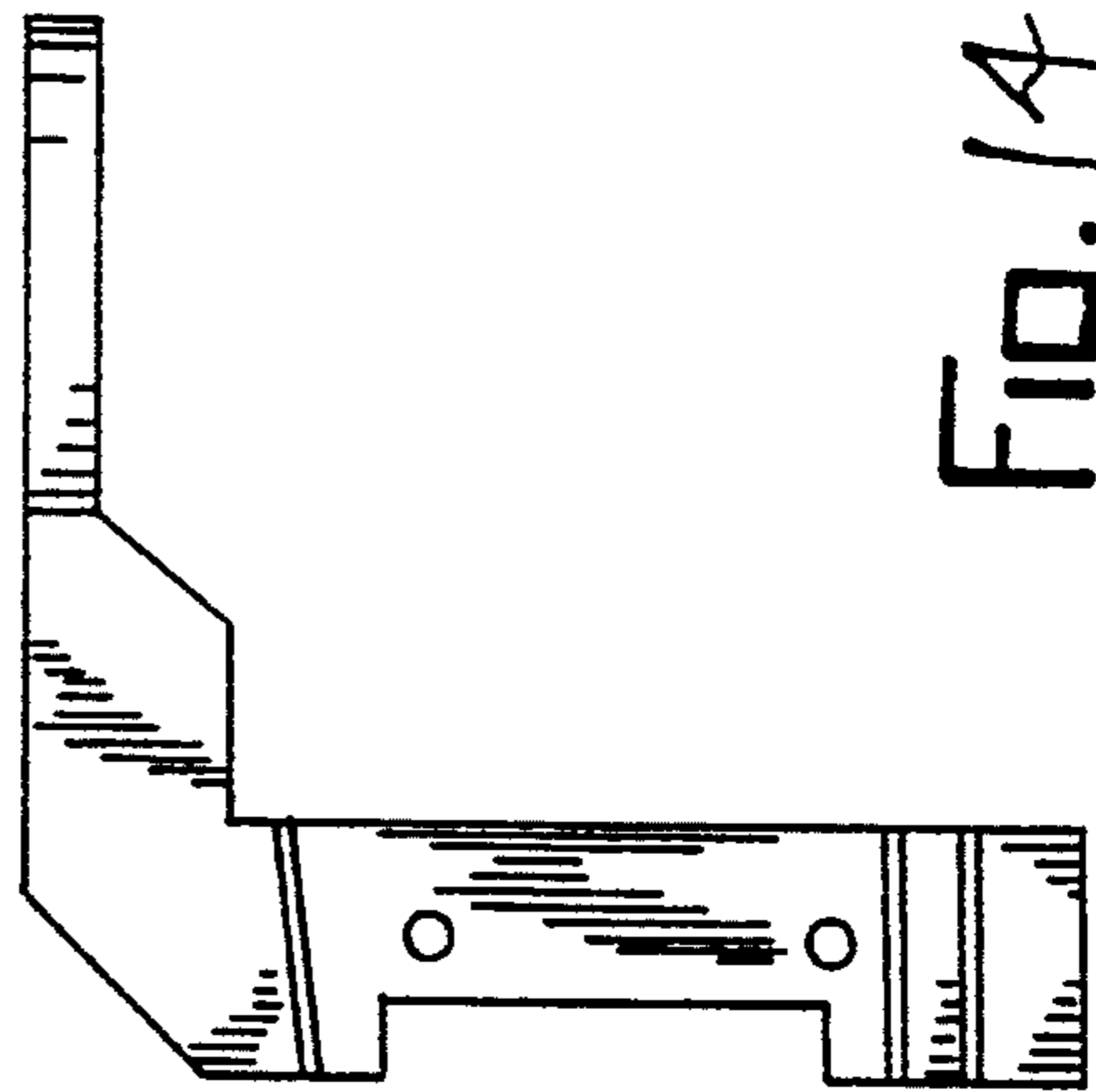

FIG. 14