



US00D355249S

# United States Patent [19]

[11] Patent Number: **Des. 355,249**

**Caruso**

[45] Date of Patent: **\*\* Feb. 7, 1995**

[54] **STEAMER FACIAL AND HAND STEAMING CONDUIT**

[76] Inventor: **Richard Caruso**, 619 Croyden Rd., Cheltenham, Pa. 19102

[\*\*] Term: **14 Years**

[21] Appl. No.: **4,242**

[22] Filed: **Jan. 29, 1993**

### Related U.S. Application Data

[63] Continuation-in-part of Ser. No. 863,449, Apr. 3, 1992, Pat. No. 5,228,213.

[52] U.S. Cl. .... **D23/363**

[58] Field of Search ..... **D28/9-12, D28/18-20, 38; D23/360-363; D24/110, 201, 203; 132/212, 271, 272; 34/90, 91, 96-101, 103, 201; 4/535, 537; 392/380, 386, 394, 397**

### [56] References Cited

#### U.S. PATENT DOCUMENTS

D. 209,364	11/1967	Katzman	.....	D24/203
D. 257,291	10/1980	Losenzo	.....	D28/19
D. 279,312	6/1985	Pohlmann	.....	D24/203 X
527,758	10/1894	Hoge	.....	4/537
1,965,424	7/1934	Mascolo	.....	4/537 X
3,120,851	2/1964	Pollak et al.	.....	132/9
3,493,722	2/1970	Popeil	.....	219/222
3,495,583	2/1970	Katzman et al.	.....	126/381
3,645,007	2/1972	Scott	.....	392/394
4,262,374	4/1981	Mikiya et al.	.....	4/537
4,314,138	2/1982	Itoh	.....	219/276
4,361,966	12/1982	Downey	.....	34/99
4,391,047	7/1983	Janssens et al.	.....	34/97
4,621,641	11/1986	Frank et al.	.....	128/368
4,759,135	7/1988	Scivoletto	.....	34/97
4,816,644	3/1989	Frank	.....	219/271
5,214,860	6/1993	Landes	.....	34/202

#### FOREIGN PATENT DOCUMENTS

1065972	6/1954	France	.....	604/289
147471	2/1904	Germany	.....	4/537

*Primary Examiner*—Bernard Ansher

*Assistant Examiner*—C. Tuttle

*Attorney, Agent, or Firm*—Woodcock Washburn Kurtz Mackewicz & Norris

### [57] CLAIM

The ornamental design for a steamer facial and hand steaming conduit, as shown and described.

### DESCRIPTION

FIG. 1 is an isometric view of the steamer facial and hand steaming conduit according to a first embodiment of my design;

FIG. 2 is an end view of the steamer facial and hand steaming conduit shown in FIG. 1;

FIG. 3 is an end view of the steamer facial and hand steaming conduit shown in FIG. 1 looking in the opposite direction from FIG. 2;

FIG. 4 is an elevation view of the steamer facial and hand steaming conduit shown in FIG. 1;

FIG. 5 is a plan view from above of the steamer facial and hand steaming conduit shown in FIG. 1;

FIG. 6 is a view from below of the steamer facial and hand steaming conduit shown in FIG. 1;

FIG. 7 is an isometric view of a second embodiment of the steamer facial and hand steaming conduit according to my design, characterized by tabs extending from its sides;

FIG. 8 is an end view of the second embodiment of the steamer facial and hand steaming conduit shown in FIG. 7;

FIG. 9 is an end view of the second embodiment of the steamer facial and hand steaming conduit shown in FIG. 7 looking in the opposite direction from FIG. 8;

FIG. 10 is an elevation view of the second embodiment of the steamer facial and hand steaming conduit shown in FIG. 7;

FIG. 11 is a plan view from above of the second embodiment of the steamer facial and hand steaming conduit shown in FIG. 7; and,

FIG. 12 is a view from below of the second embodiment of the steamer facial and hand steaming conduit shown in FIG. 7.

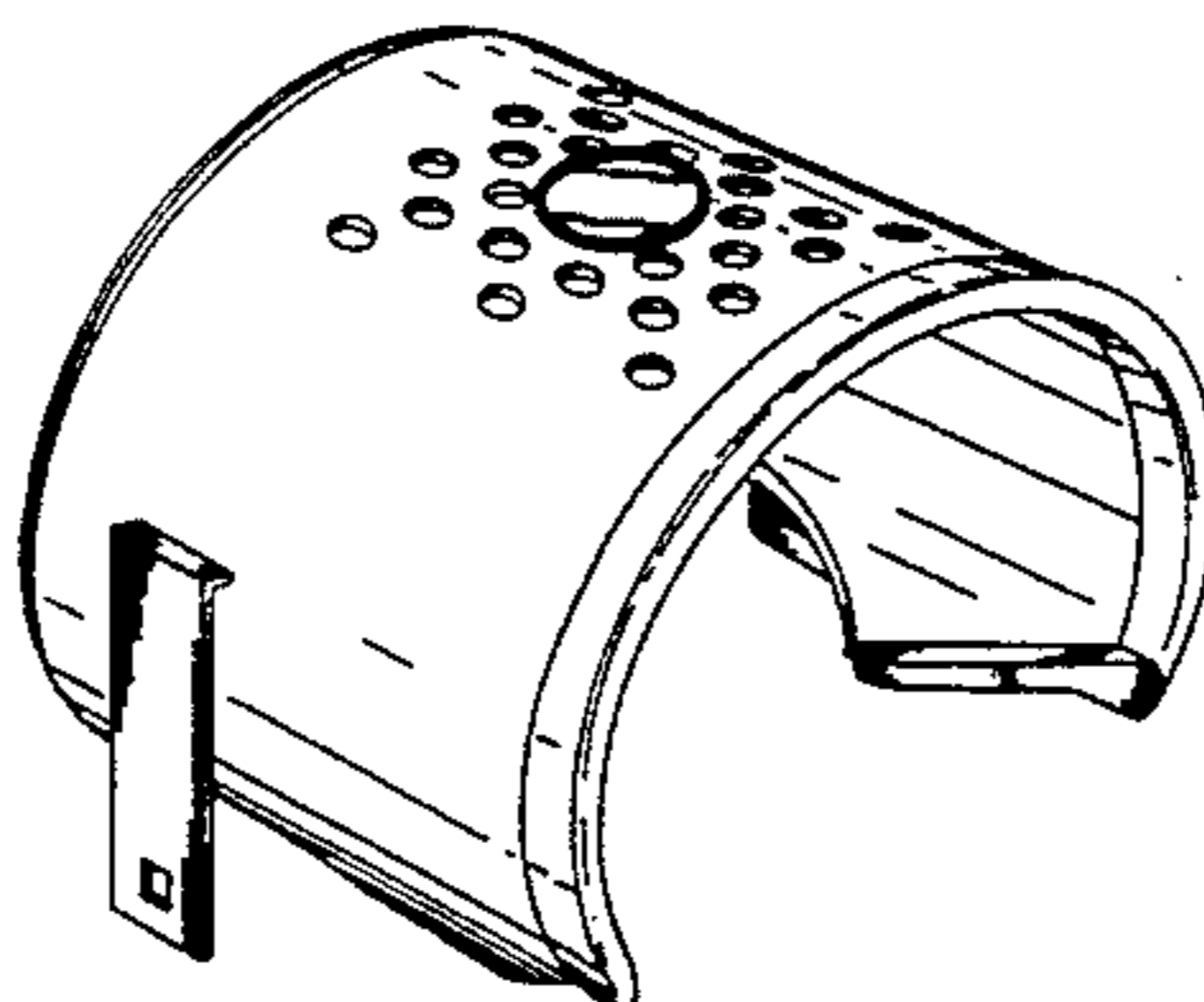
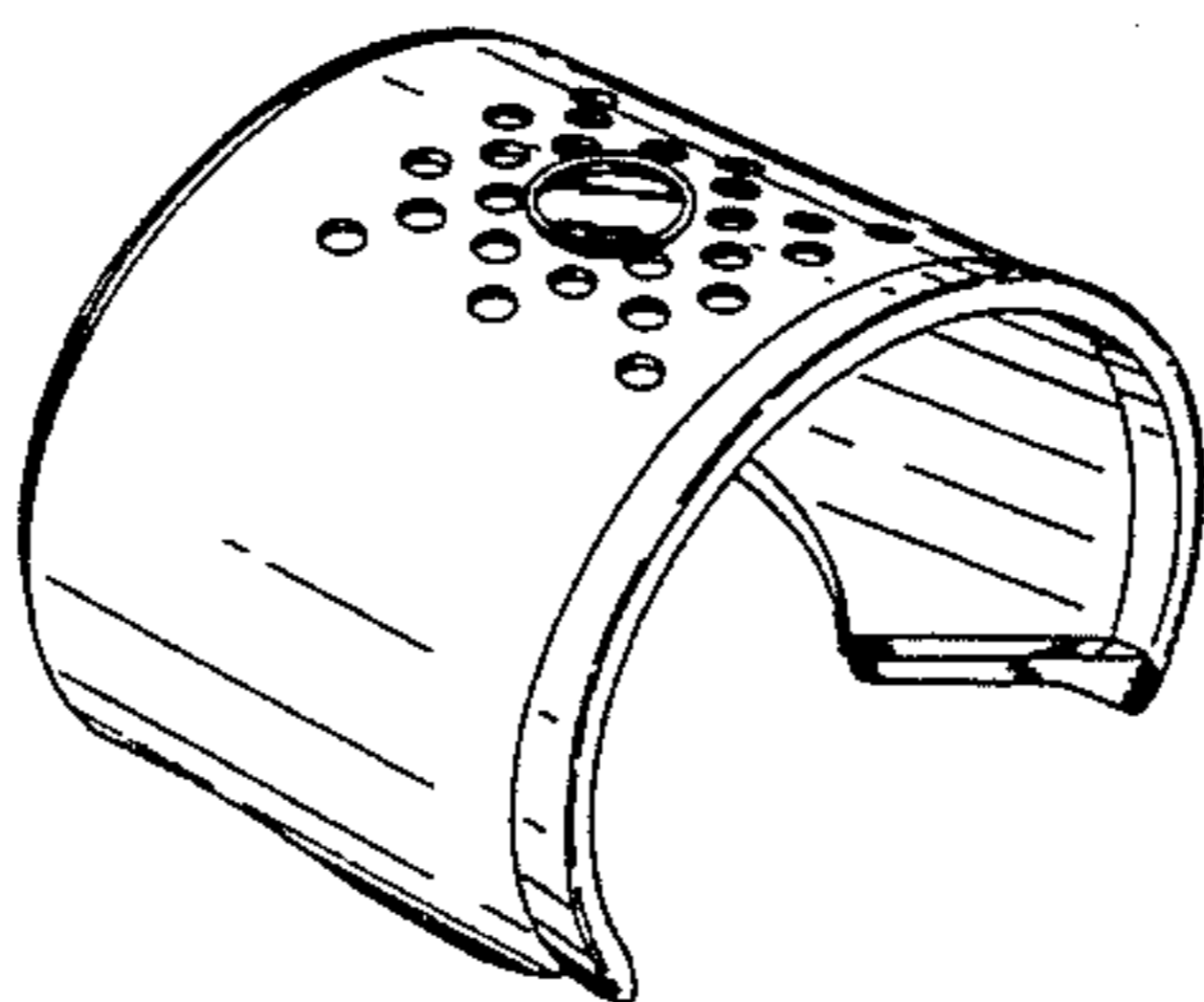

*FIG. 1*

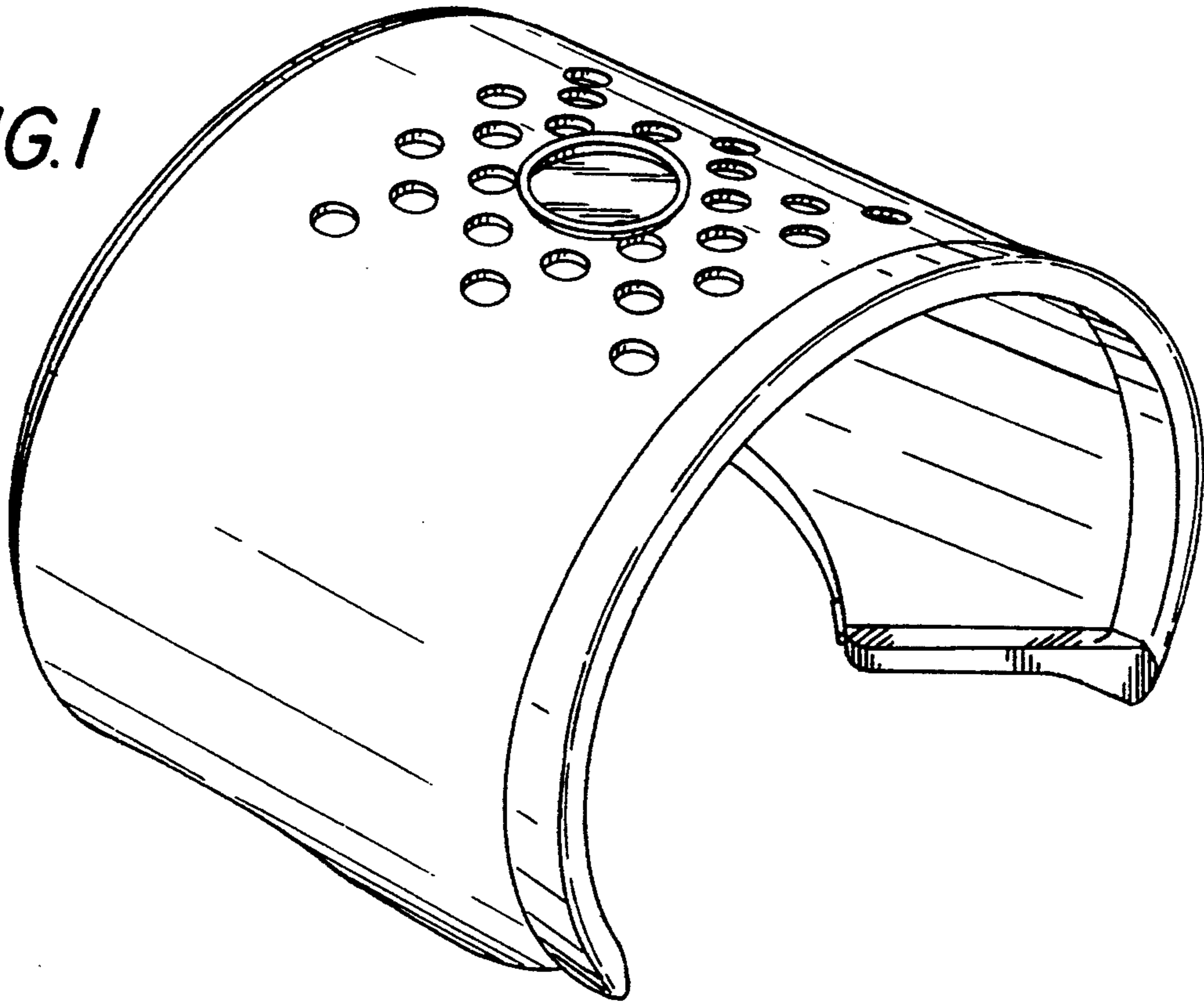

*FIG. 2*

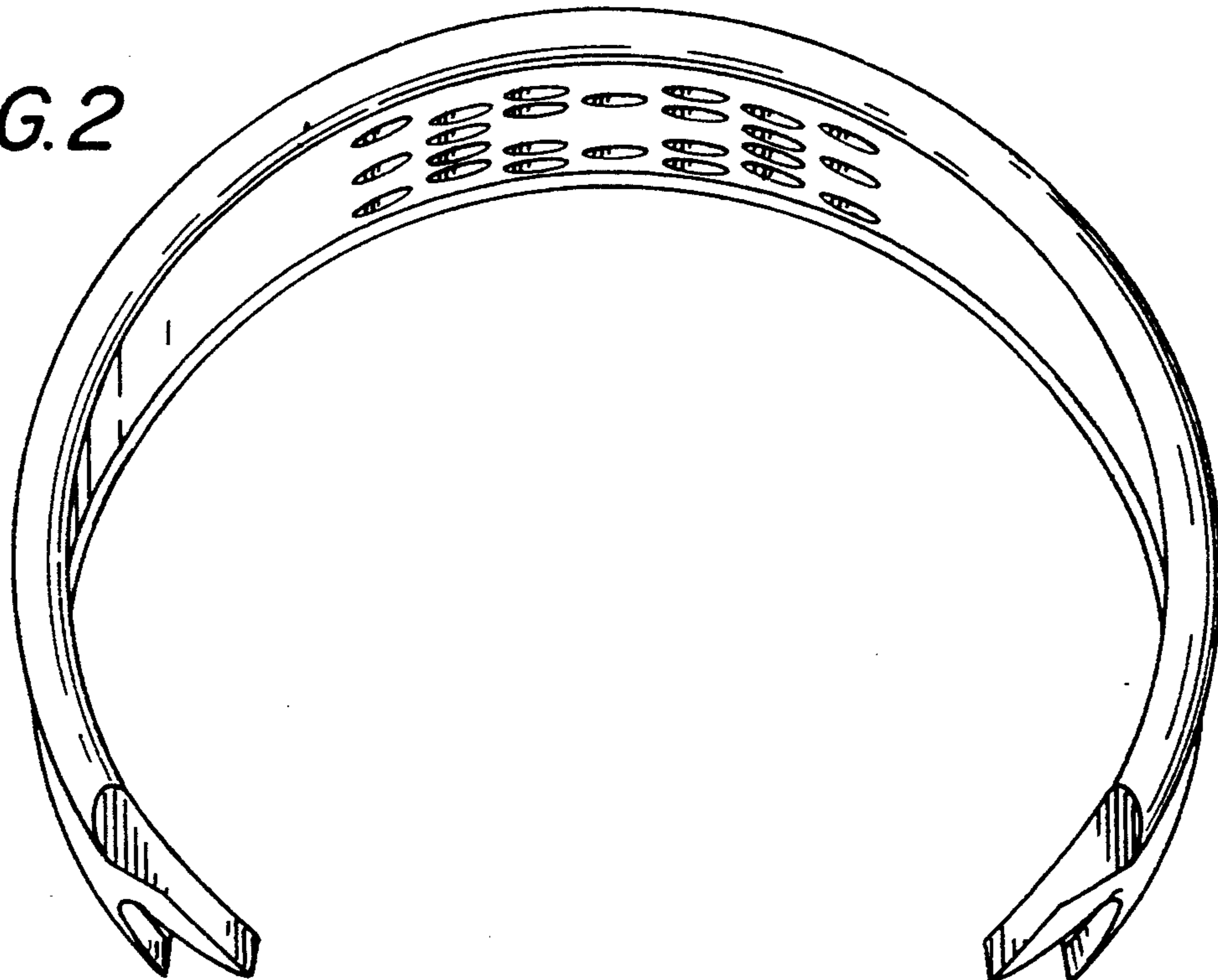

*FIG.3*

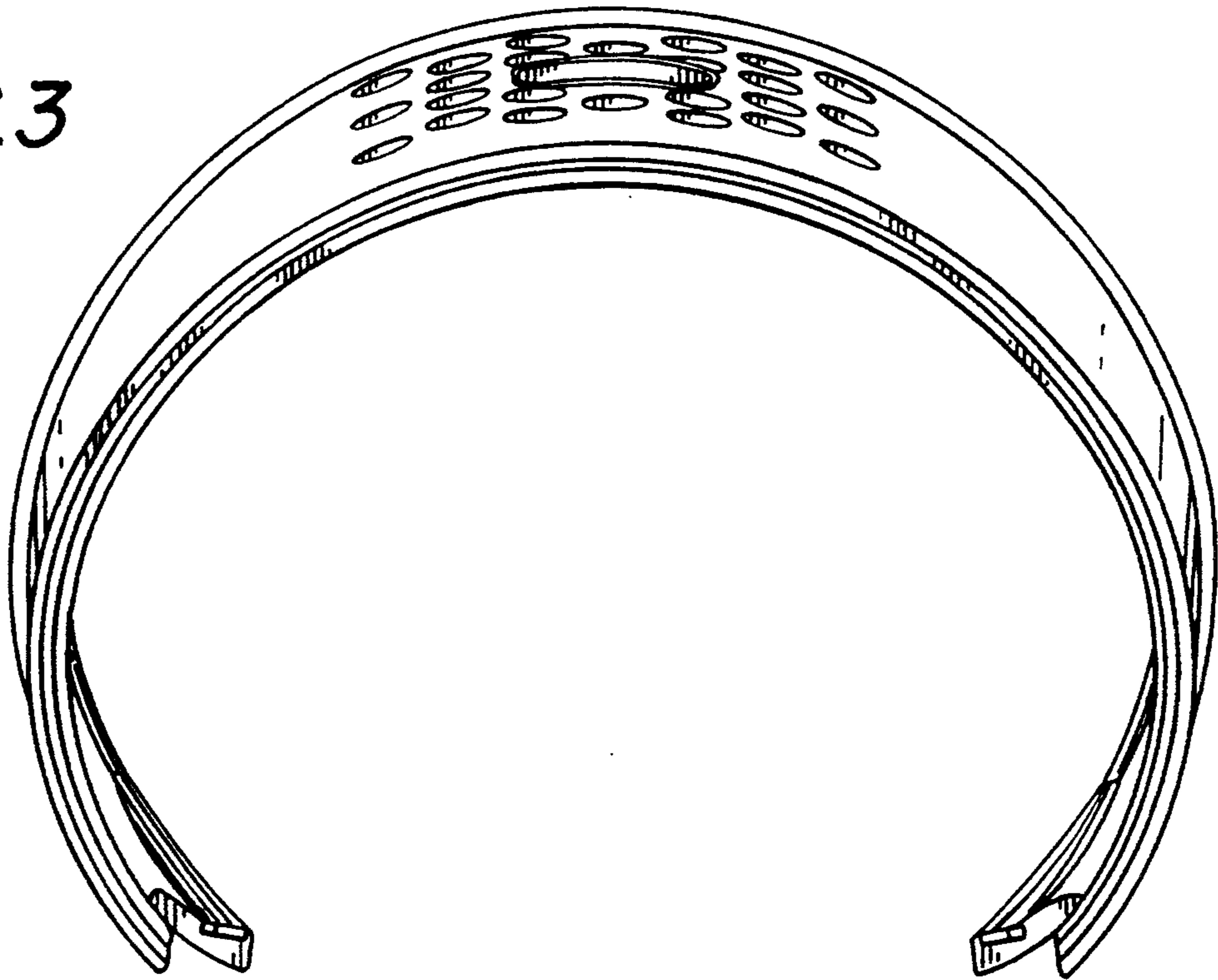

*FIG.4*

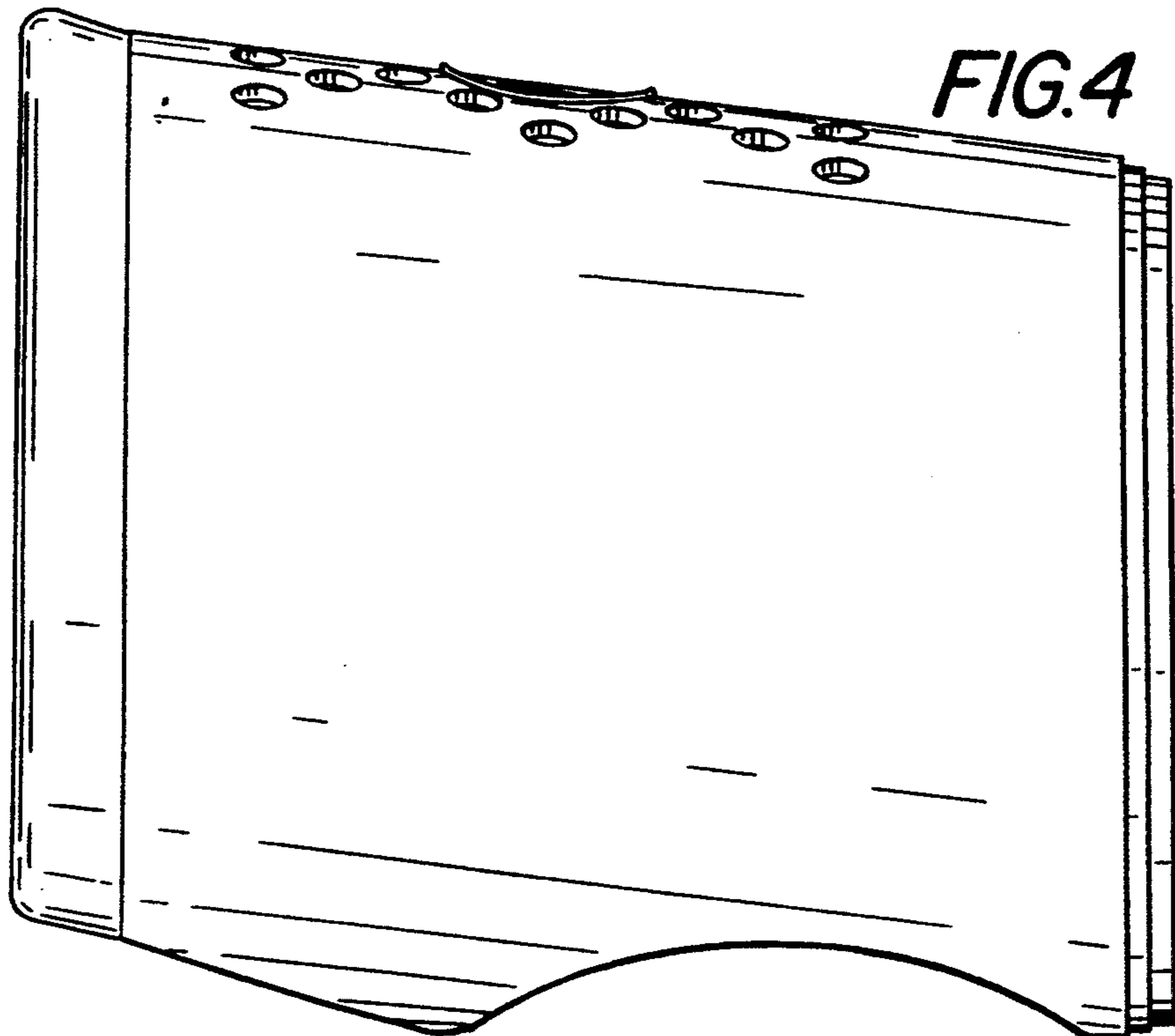

*FIG. 5*

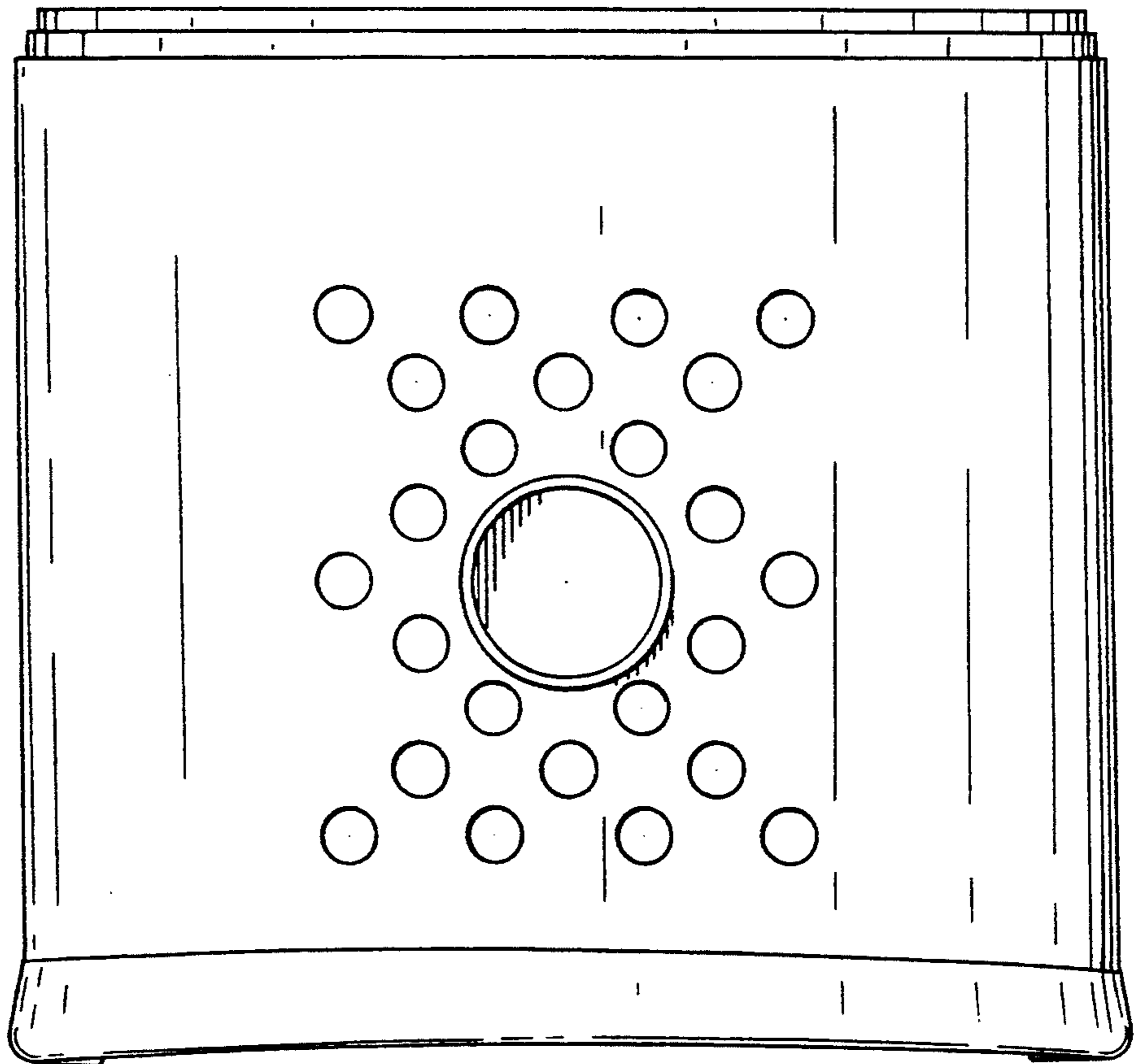

*FIG. 6*

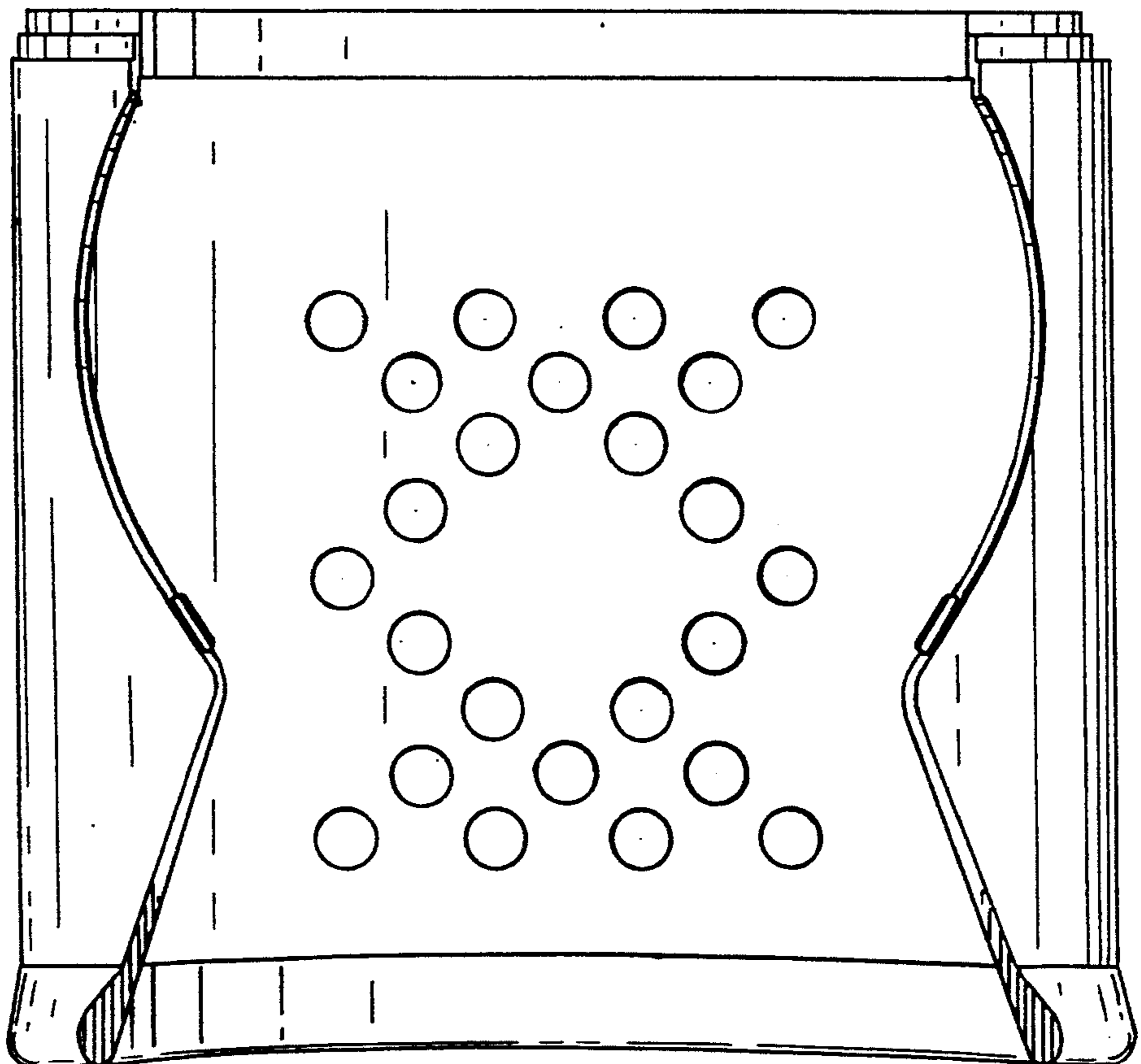

FIG. 7

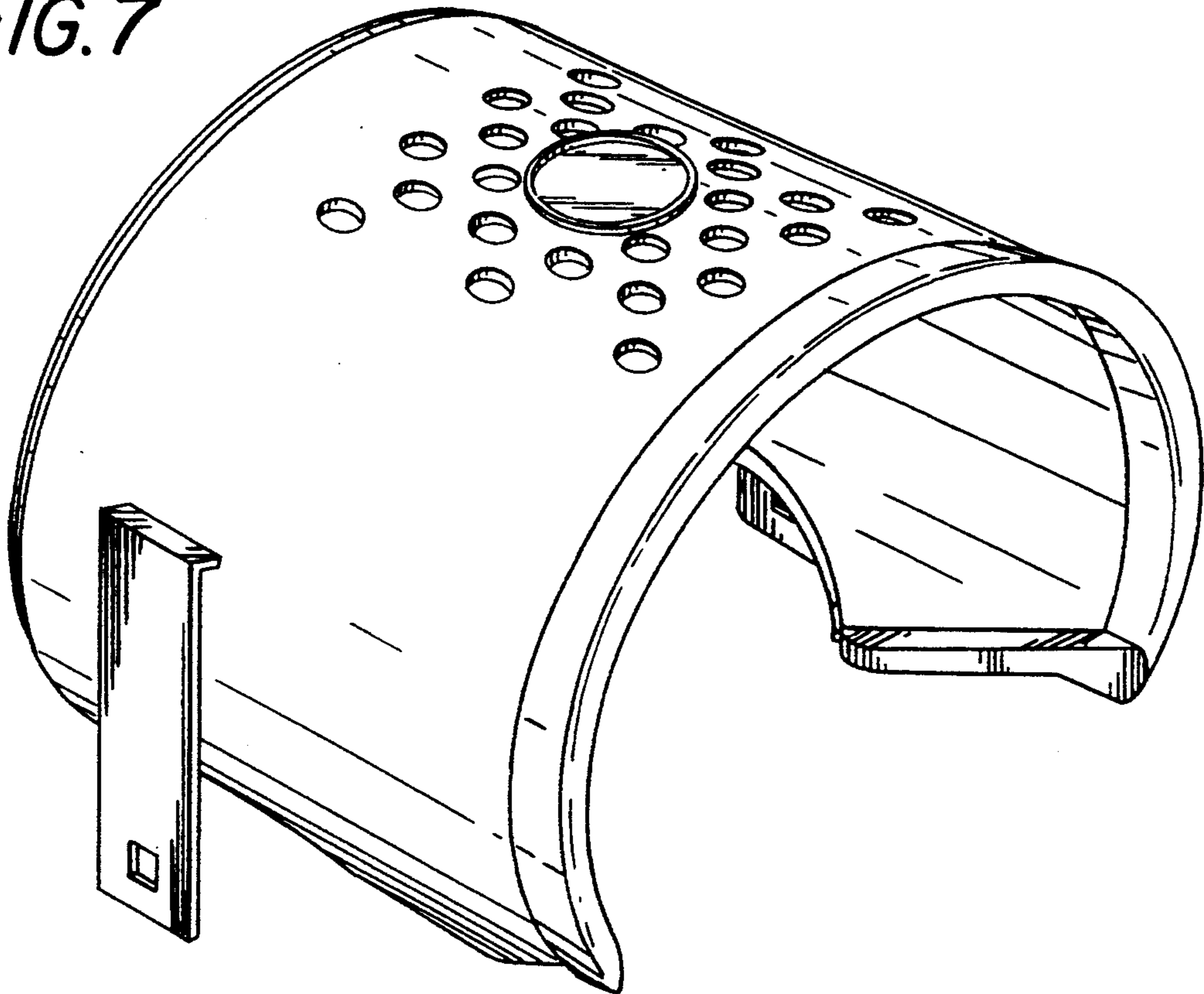
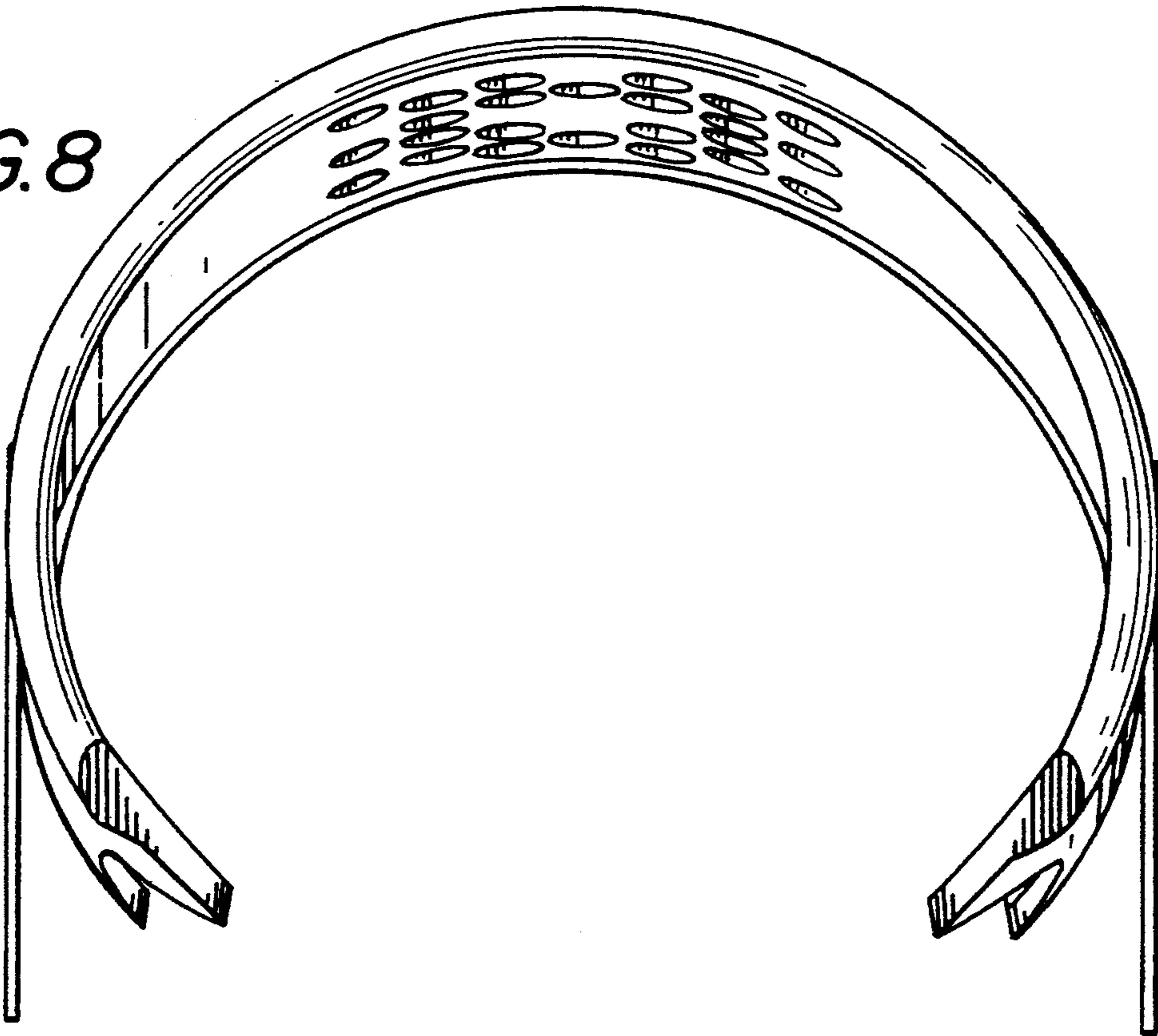
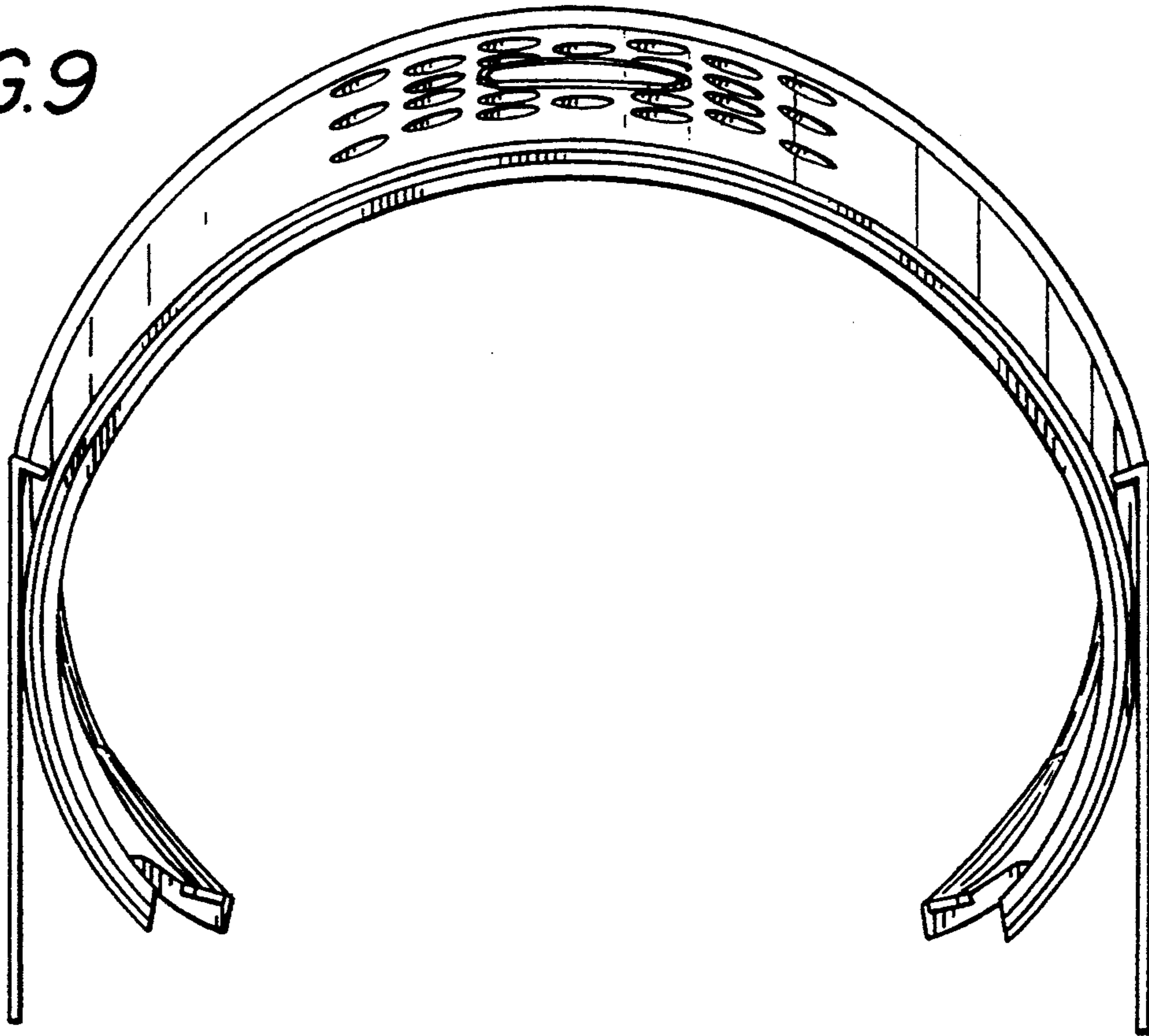

FIG. 8



*FIG. 9*



*FIG. 10*

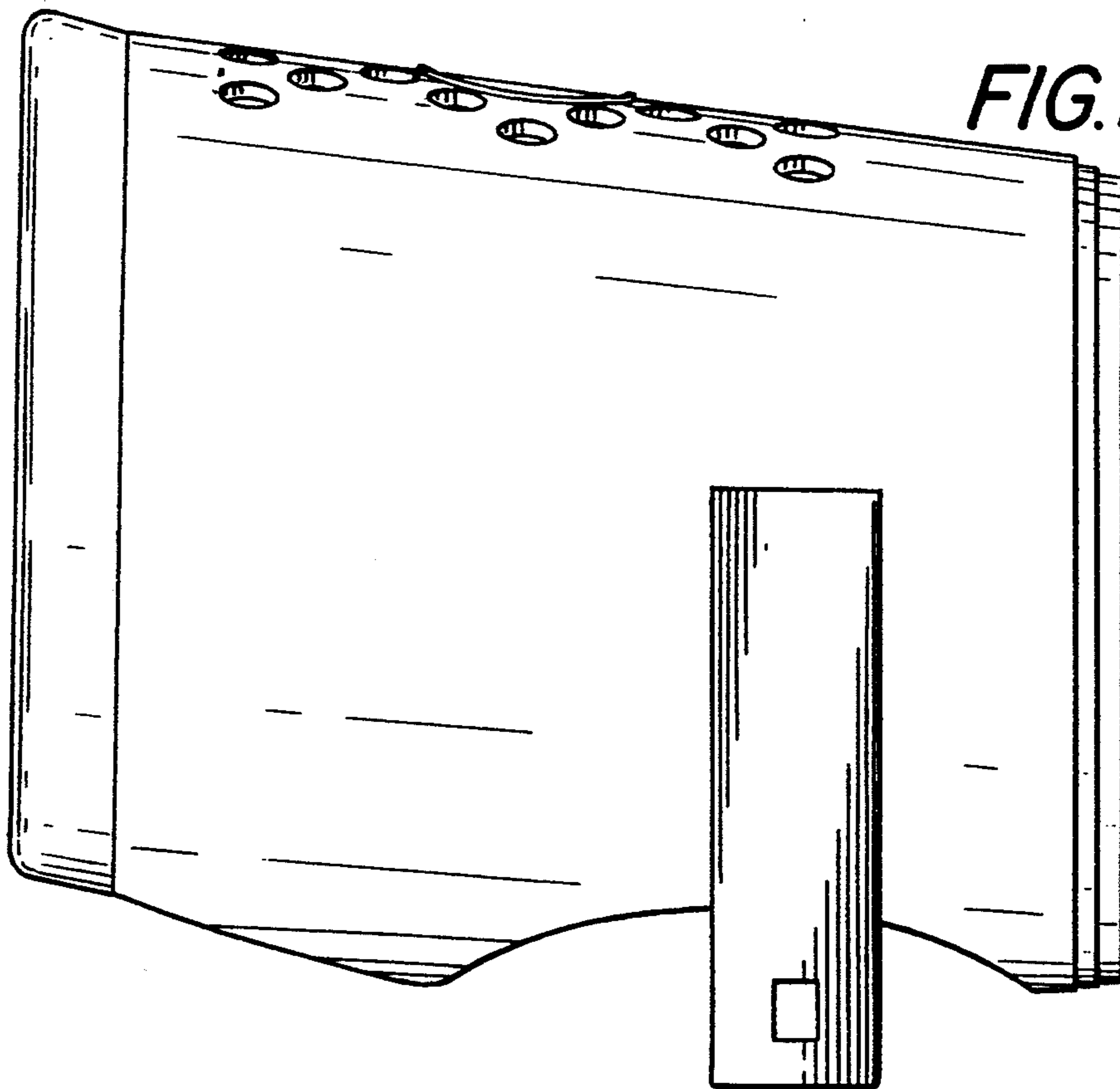

*FIG. 11*

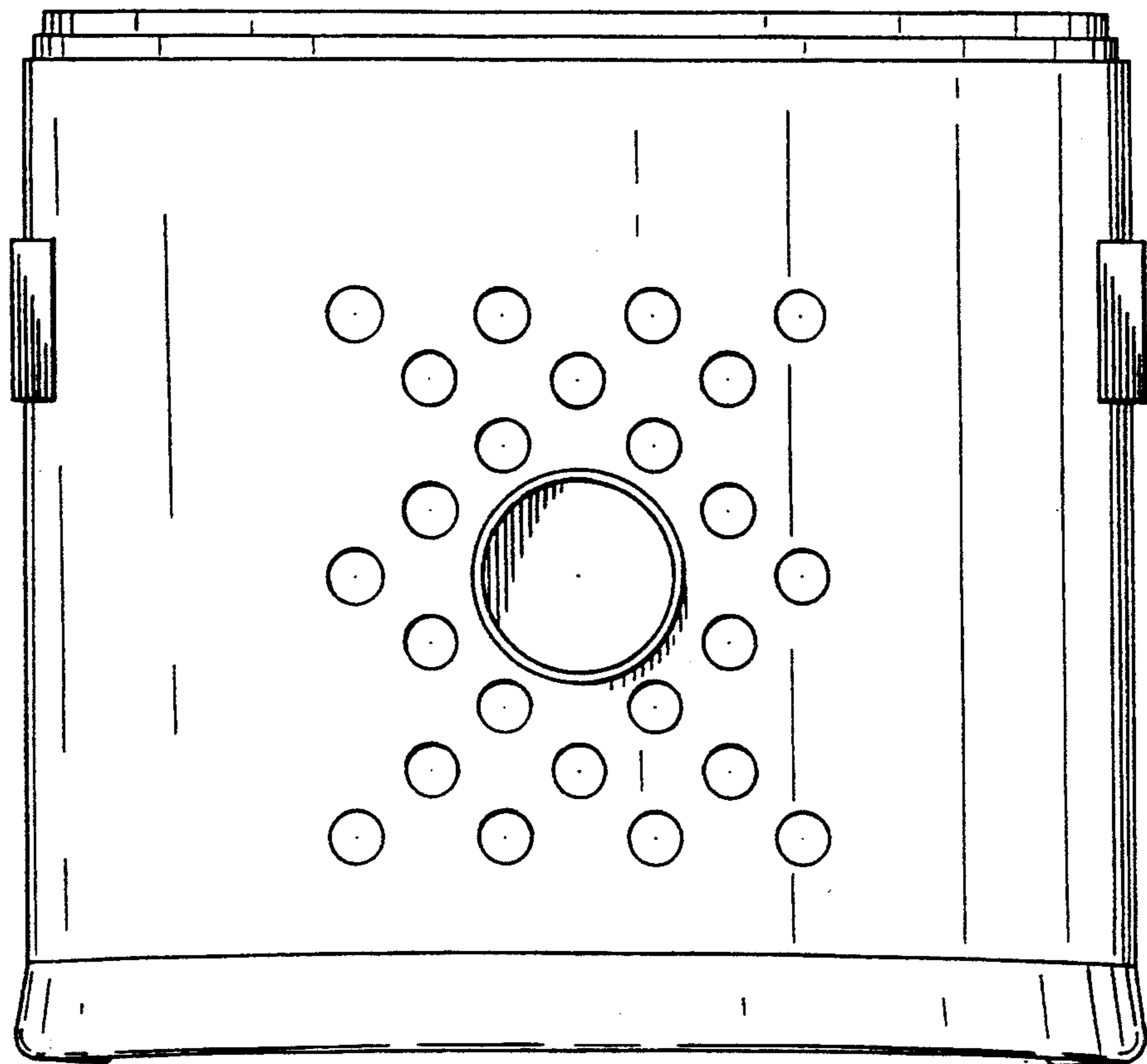

*FIG. 12*

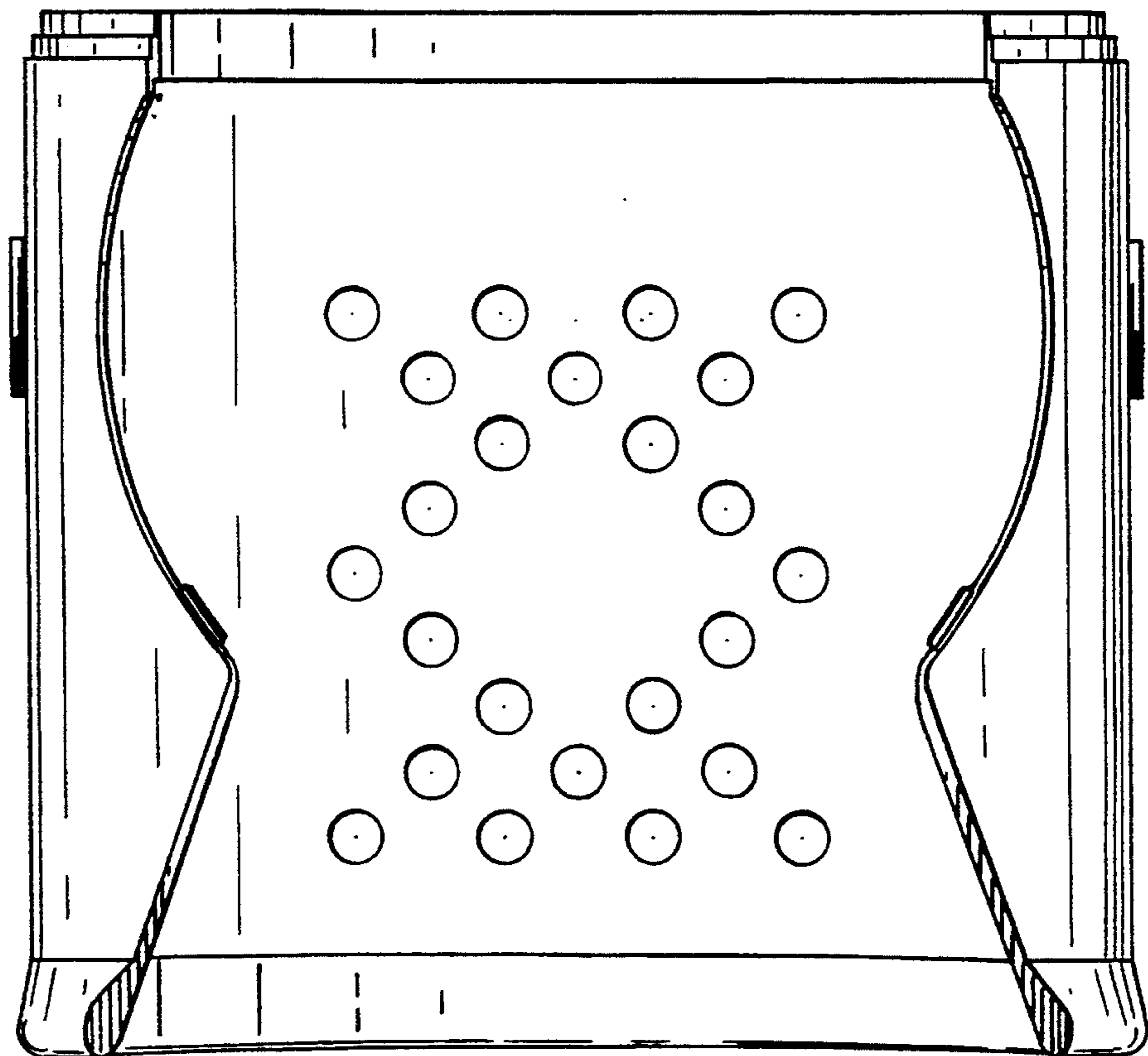

UNITED STATES PATENT AND TRADEMARK OFFICE  
**CERTIFICATE OF CORRECTION**

PATENT NO. : D355,249  
DATED : February 7, 1995  
INVENTOR(S) : Richard Caruso

It is certified that error appears in the above-identified patent and that said Letters Patent is hereby corrected as shown below:

TITLE PAGE, ITEM [56],  
Please insert the following references under U.S. PATENT DOCUMENTS:

--5,010,905	4/1991	Snyder et al.
2,881,755	4/1959	Diehl
3,495,343	2/1970	Duncanson--

Signed and Sealed this  
Thirteenth Day of June, 1995

Attest:



BRUCE LEHMAN

Attesting Officer

Commissioner of Patents and Trademarks