



US00D355212S

United States Patent [19]

[11] Patent Number: **Des. 355,212**

Kubota et al.

[45] Date of Patent: **** Feb. 7, 1995**

[54] **PRINTING HEAD FOR PRINTER**
[75] Inventors: **Hidemi Kubota, Komae; Toshihiko Ujita, Yamato; Torachika Osada, Yokohama; Kenjiro Watanabe, Tokyo; Kayomi Sato, Kawasaki, all of Japan**

D. 341,619 11/1993 Ujita et al. D18/56
D. 341,620 11/1993 Ujita et al. D18/56
4,992,802 2/1991 Dion et al. 346/140 R
5,162,517 11/1992 Tajika et al. 346/140 R
5,187,498 2/1993 Burger 346/140 R

[73] Assignee: **Canon Kabushiki Kaisha, Tokyo, Japan**

FOREIGN PATENT DOCUMENTS

3958 1/1988 Japan 346/140 R
4954 1/1988 Japan 346/140 R
37954 2/1988 Japan 346/140 R

[**] Term: **14 Years**

Primary Examiner—Cathy Anne MacCormac
Attorney, Agent, or Firm—Fitzpatrick, Cella, Harper & Scinto

[21] Appl. No.: **10,088**

[22] Filed: **Jun. 28, 1993**

[57] CLAIM

[30] Foreign Application Priority Data

Dec. 29, 1992 [JP] Japan 4-38906

The ornamental design for a printing head for printer, as shown and described.

[52] U.S. Cl. **D18/56**

DESCRIPTION

[58] Field of Search D18/12, 56; 346/140 R; 400/208, 234

FIG. 1 is a front elevational view of a printing head for printer showing our new design;
FIG. 2 is a rear elevational view thereof;
FIG. 3 is a top plan view thereof;
FIG. 4 is a bottom plan view thereof;
FIG. 5 is a left side elevational view thereof;
FIG. 6 is a right side elevational view thereof; and,
FIG. 7 is a perspective view thereof.

[56] References Cited

U.S. PATENT DOCUMENTS

D. 338,232 8/1993 Kotaki et al. D18/56
D. 338,234 8/1993 Watanabe et al. D18/56
D. 338,489 8/1993 Ujita et al. D18/56
D. 338,911 8/1993 Ujita et al. D18/56

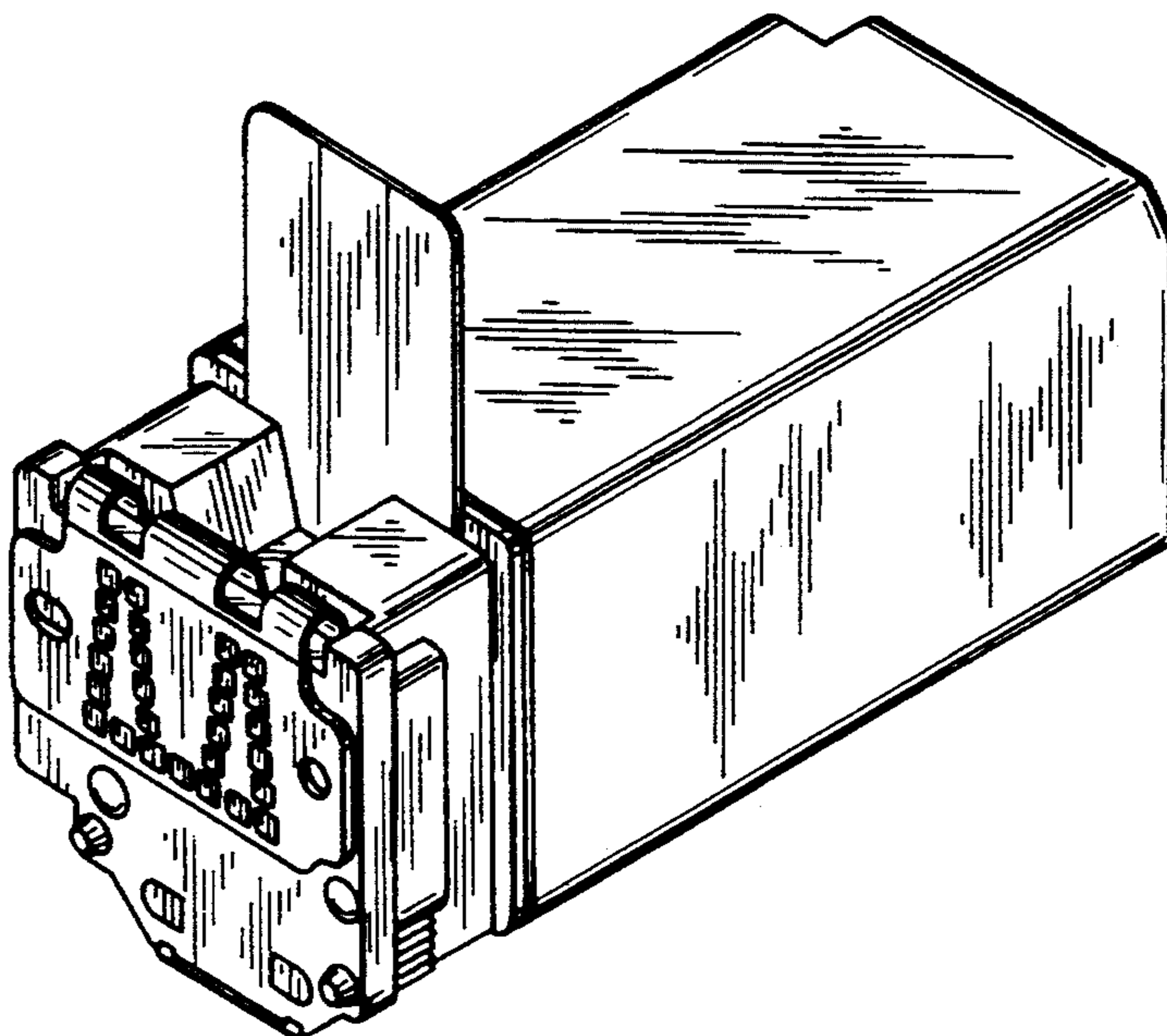

FIG. 1

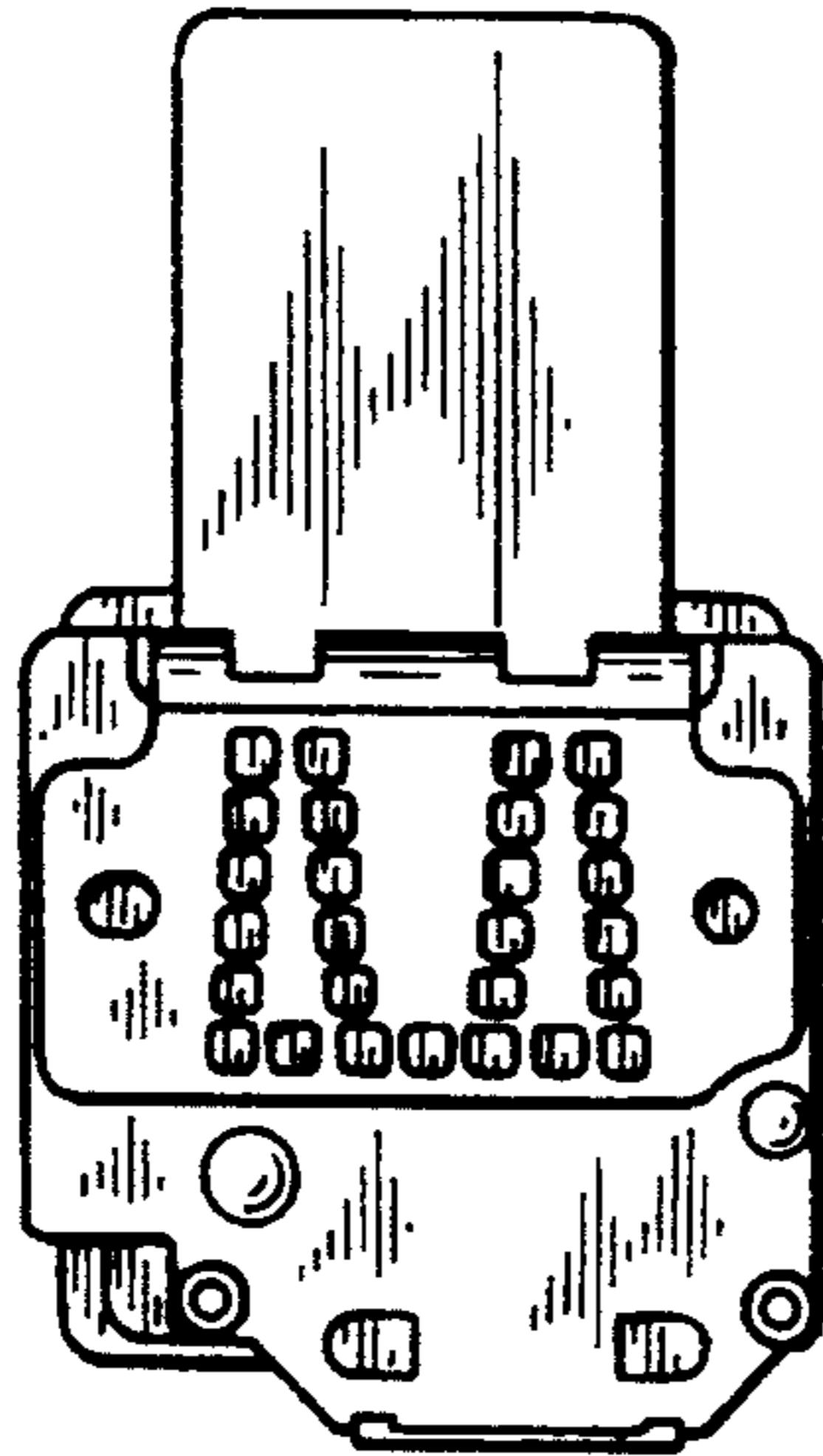

FIG. 2

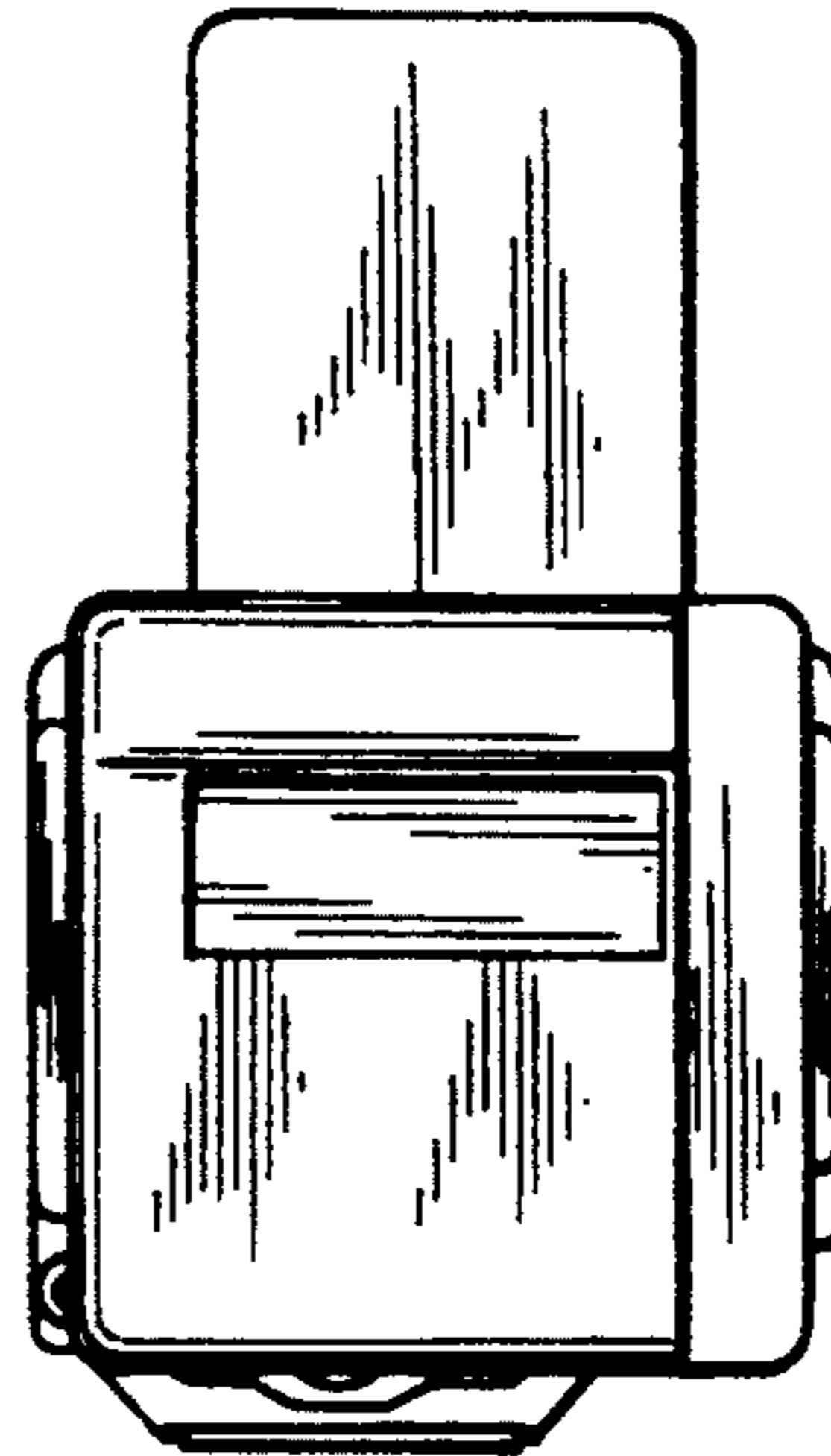

FIG. 3

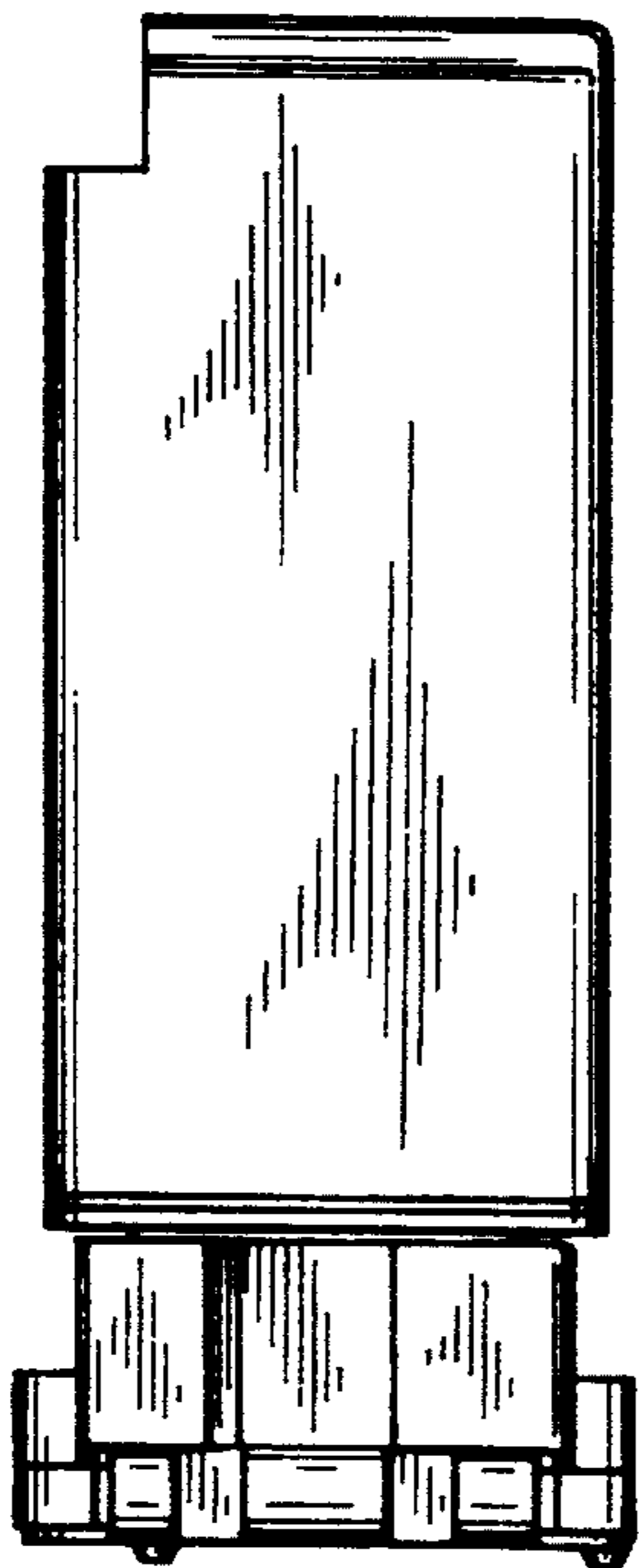

FIG. 4

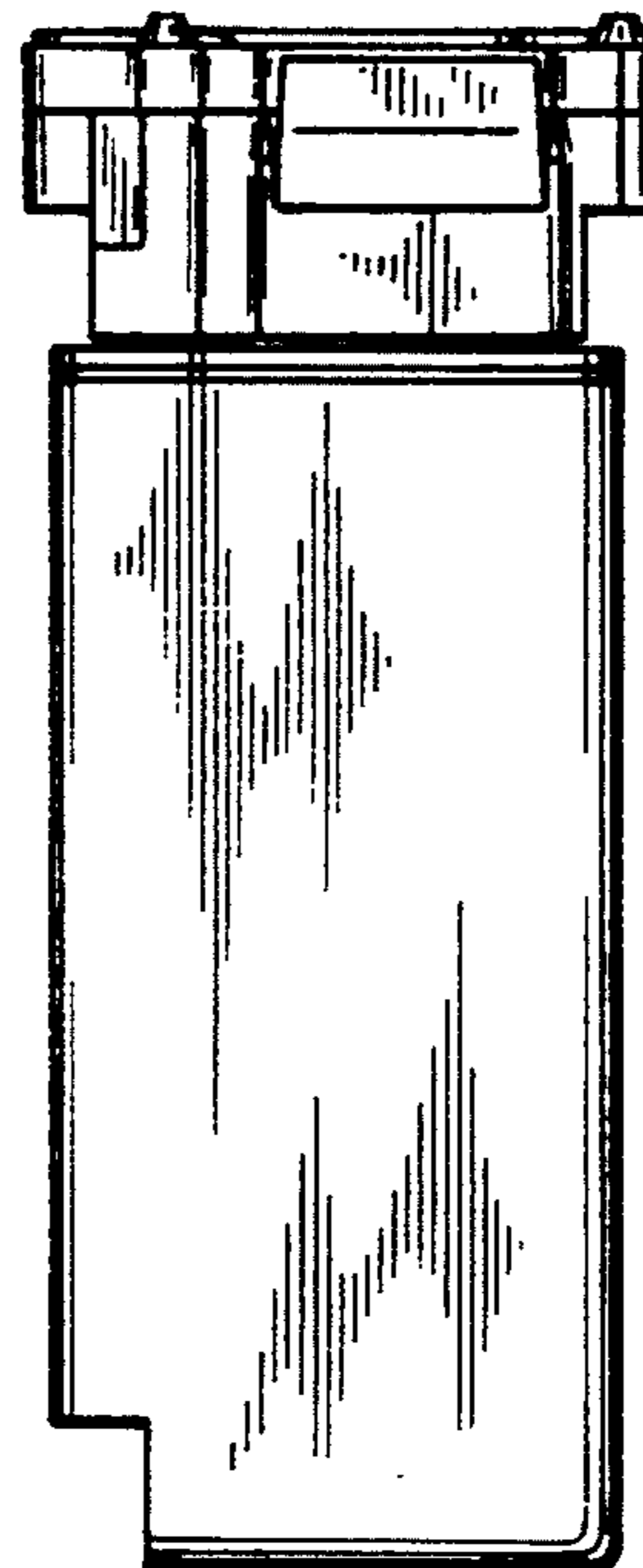

FIG. 5

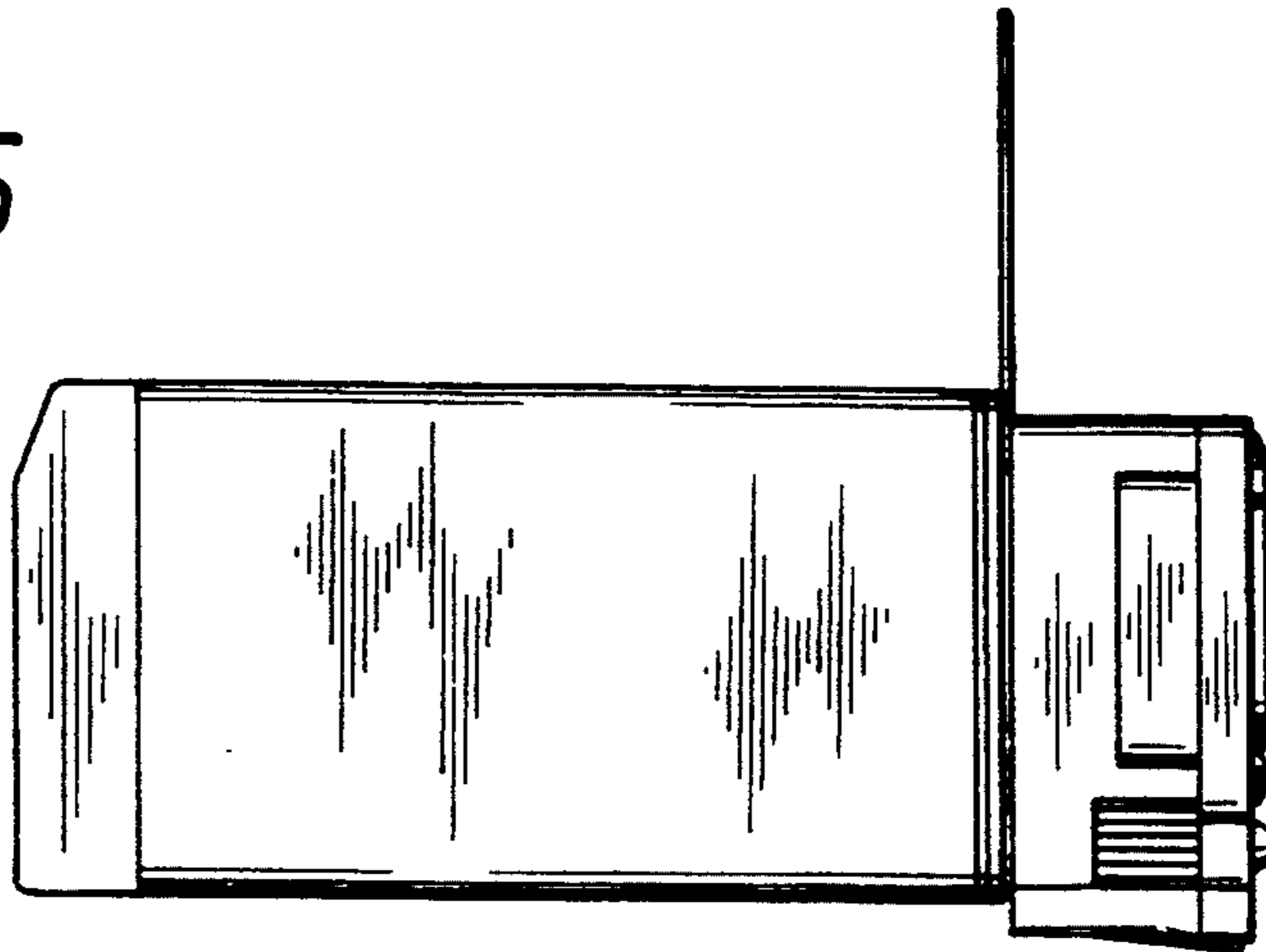

FIG. 6

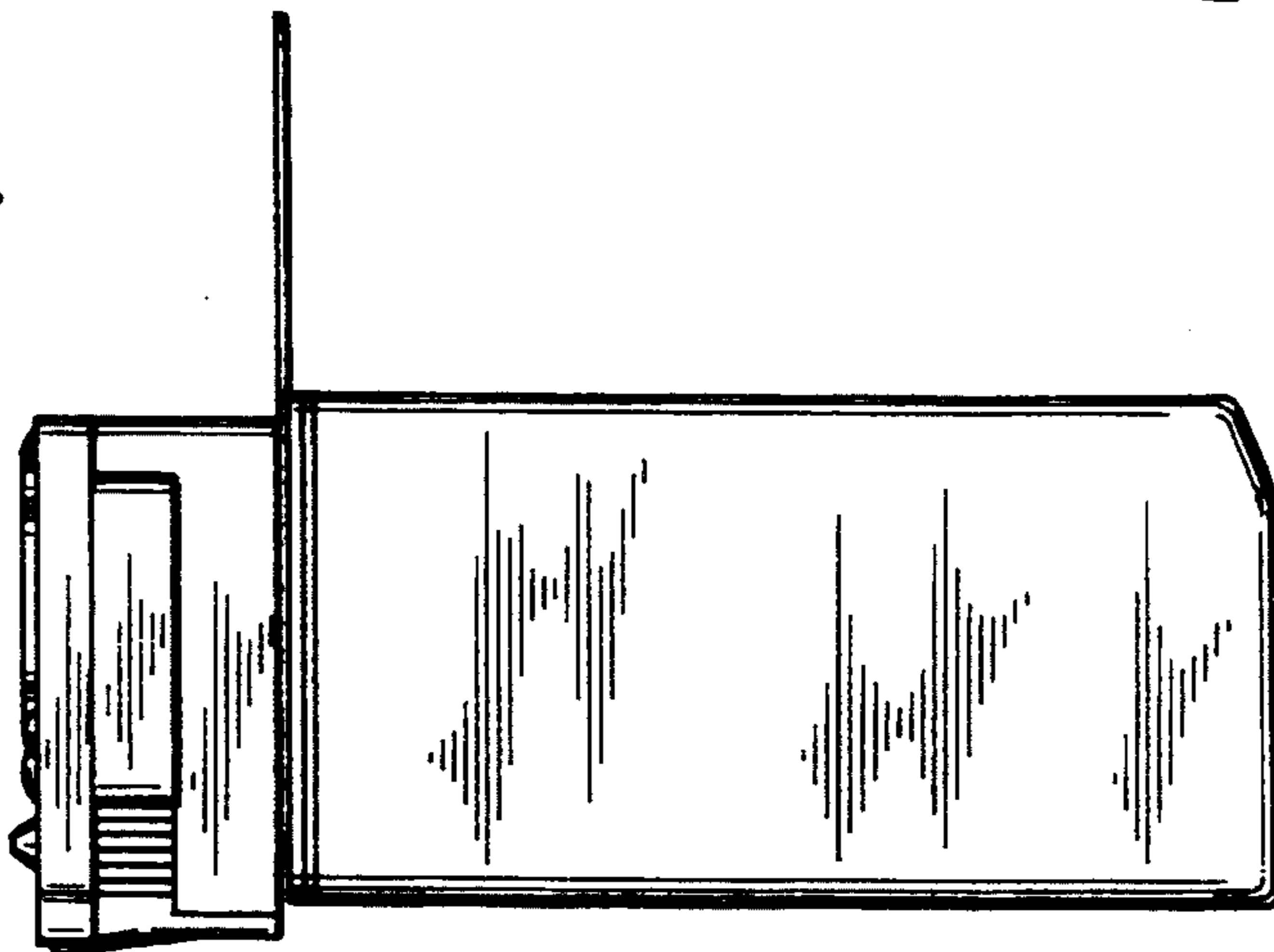

FIG. 7

