



US00D355191S

United States Patent [19]

[11] Patent Number: **Des. 355,191**

Meurer

[45] Date of Patent: **** Feb. 7, 1995**

[54] TELEPHONE

[75] Inventor: **Eberhard Meurer**, Furtwangen, Germany

[73] Assignee: **S. Siedle & Sohne**, Germany

[**] Term: **14 Years**

[21] Appl. No.: **820,949**

[22] Filed: **Jan. 9, 1992**

[52] U.S. Cl. **D14/149**

[58] Field of Search D14/140, 138, 142, 141, D14/149-151, 148; 379/357, 440, 419, 420, 435

[56] **References Cited**

U.S. PATENT DOCUMENTS

D. 272,533	2/1984	Coons et al.	D14/149 X
D. 287,586	1/1987	Tanaka et al.	D14/151
D. 287,721	1/1987	Perkins	D14/151
D. 287,851	1/1987	Hoi	D14/151
D. 298,827	12/1988	Miozzo	D14/149
D. 298,828	12/1988	Miozzo	D14/149
D. 316,857	5/1991	Park	D14/148 X
D. 324,681	3/1992	Klucznik et al.	D14/141

OTHER PUBLICATIONS

Panasonic ad.

Primary Examiner—Alan P. Douglas

Assistant Examiner—Jeffrey Asch

Attorney, Agent, or Firm—Shlesinger, Fitzsimmons & Shlesinger

[57] **CLAIM**

The ornamental design for a telephone, as shown and described.

DESCRIPTION

FIG. 1 is a front elevational view of a telephone showing my new design;

FIG. 2 is a front and right side perspective view;

FIG. 3 is a front elevational view with the handset removed from the base;

FIG. 4 is a left side elevational view;

FIG. 5 is a front perspective view of a second embodiment of the telephone shown in FIG. 1;

FIG. 6 is a rear perspective view;

FIG. 7 is a left side perspective view;

FIG. 8 is a perspective view of a third embodiment of the telephone shown in FIG. 1;

FIG. 9 is a front elevational view;

FIG. 10 is a top plan view;

FIG. 11 is a right side perspective view;

FIG. 12 is a perspective view of the handset;

FIG. 13 is a perspective view of the handset;

FIG. 14 is a right side elevational view of the handset; and,

FIG. 15 is a bottom elevational view of the FIG. 1 embodiment.

The telephone handset has been shown separately in FIGS. 12-14 for convenience of illustration.

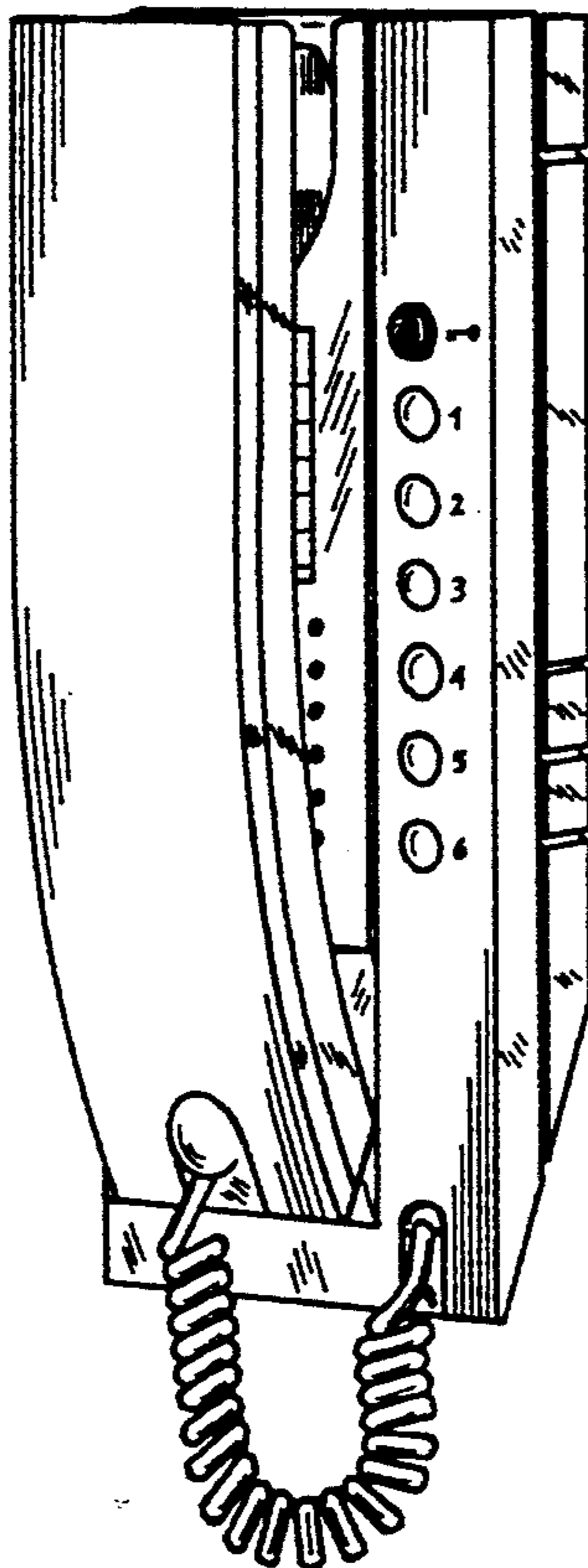

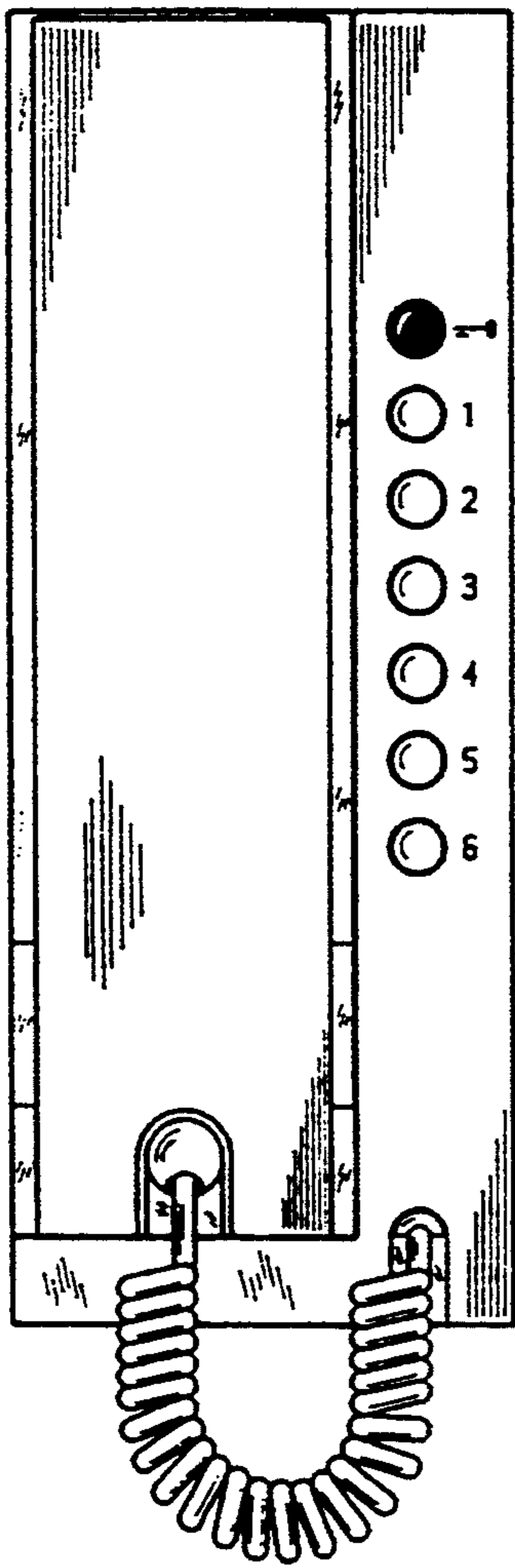

Fig. 1

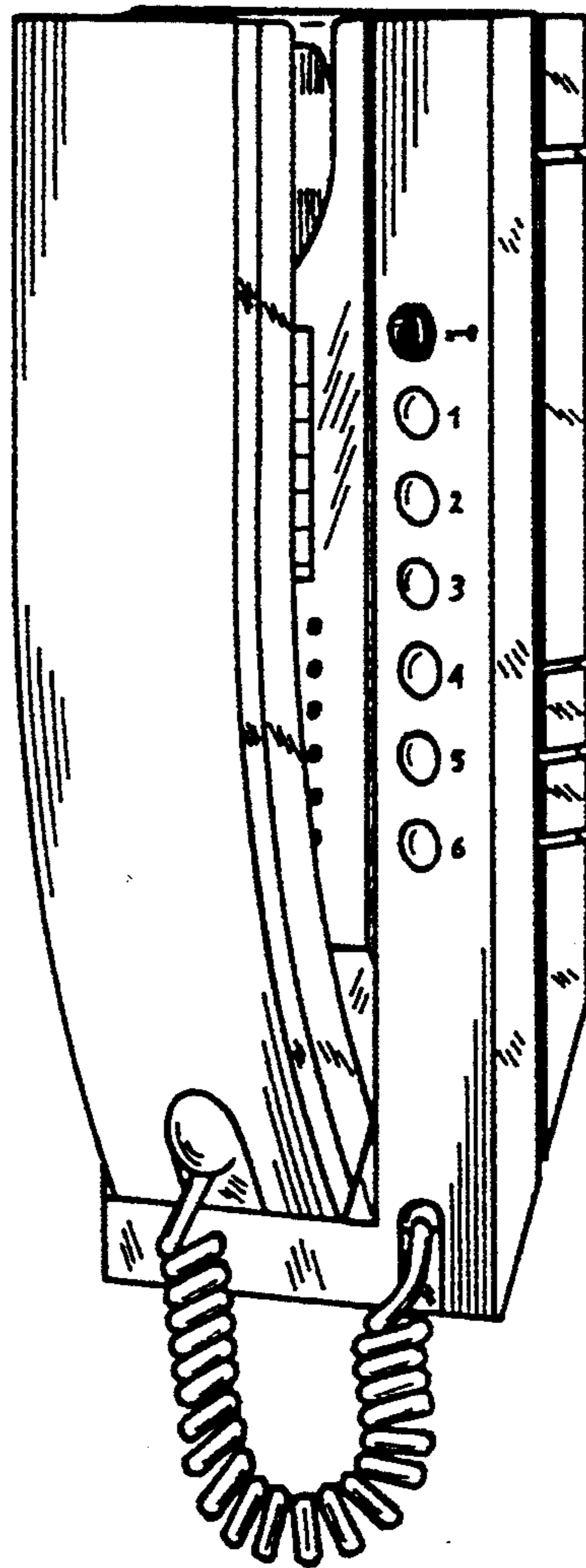

Fig. 2

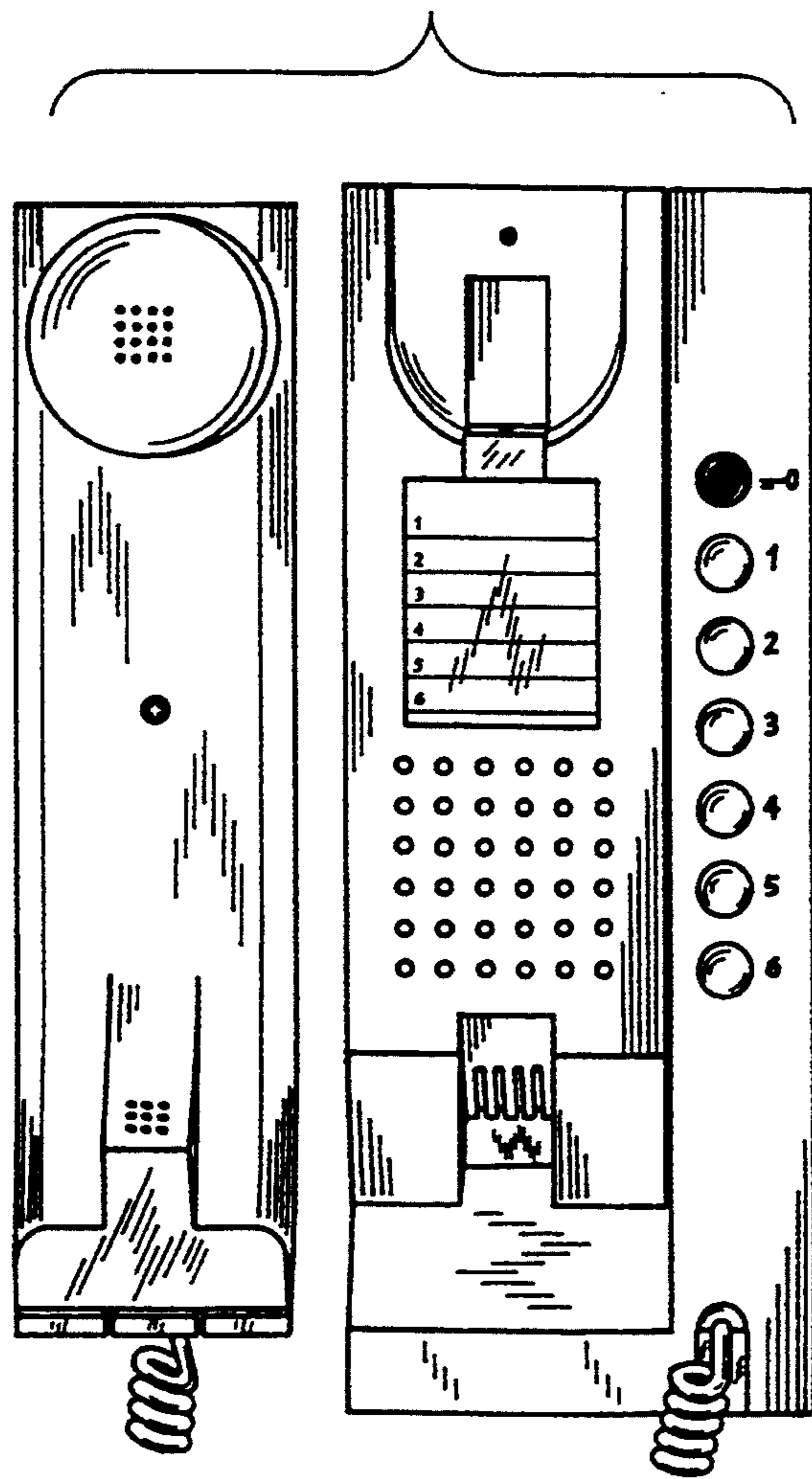

Fig. 3

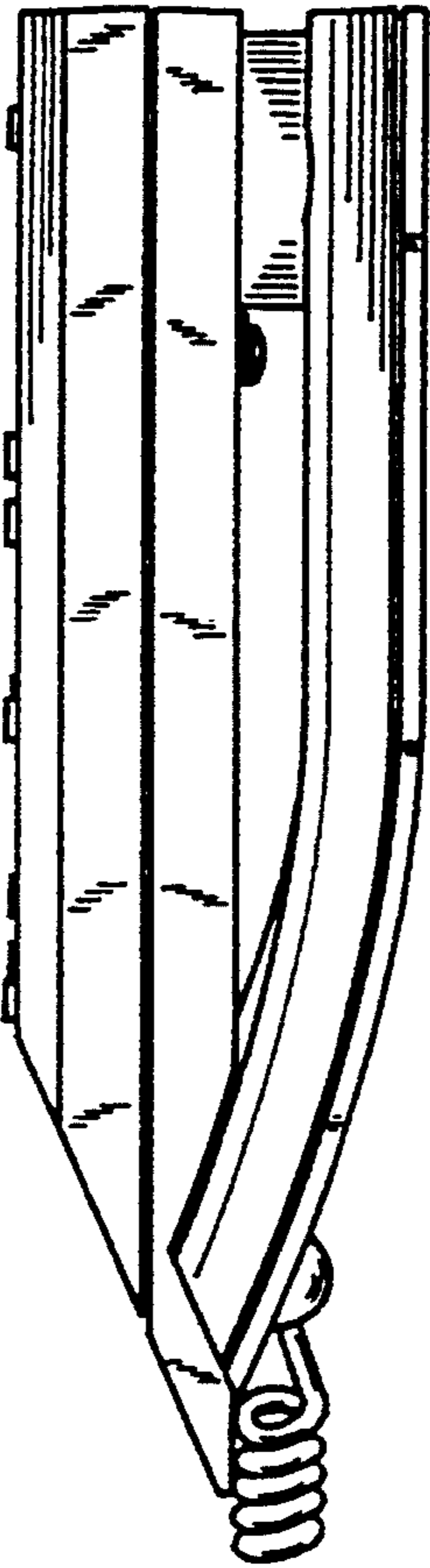

Fig. 4

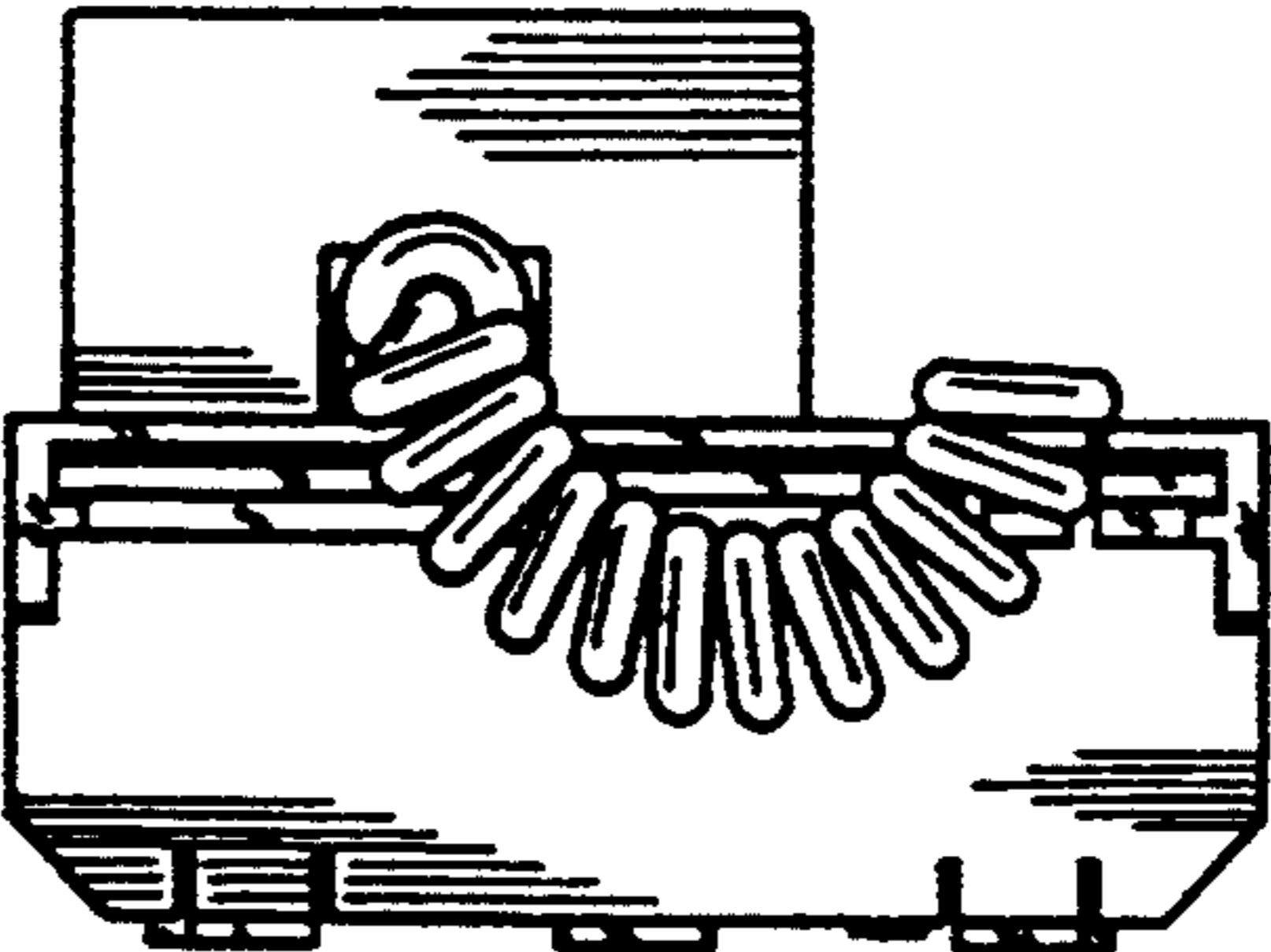

Fig. 15

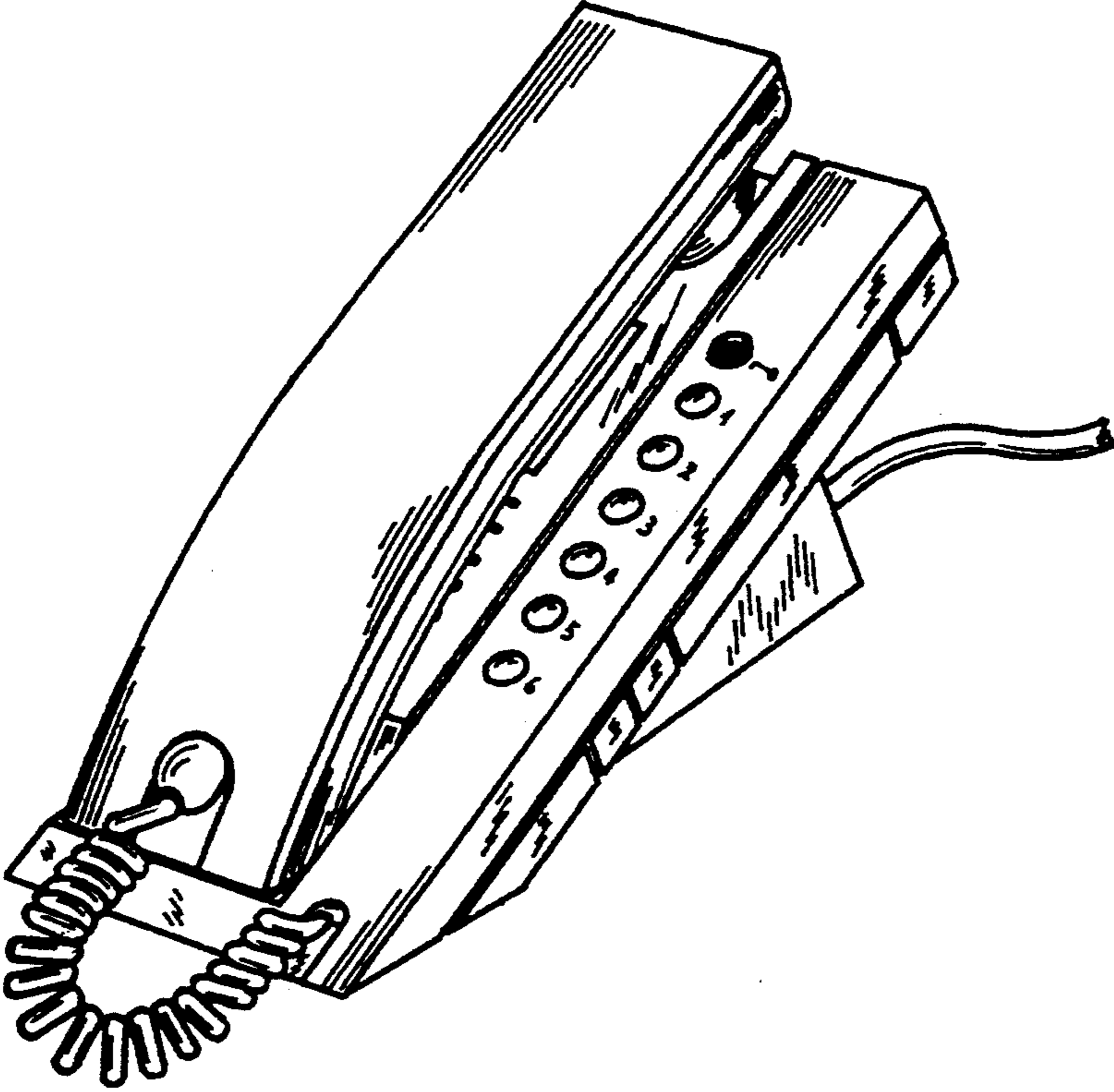

Fig. 5

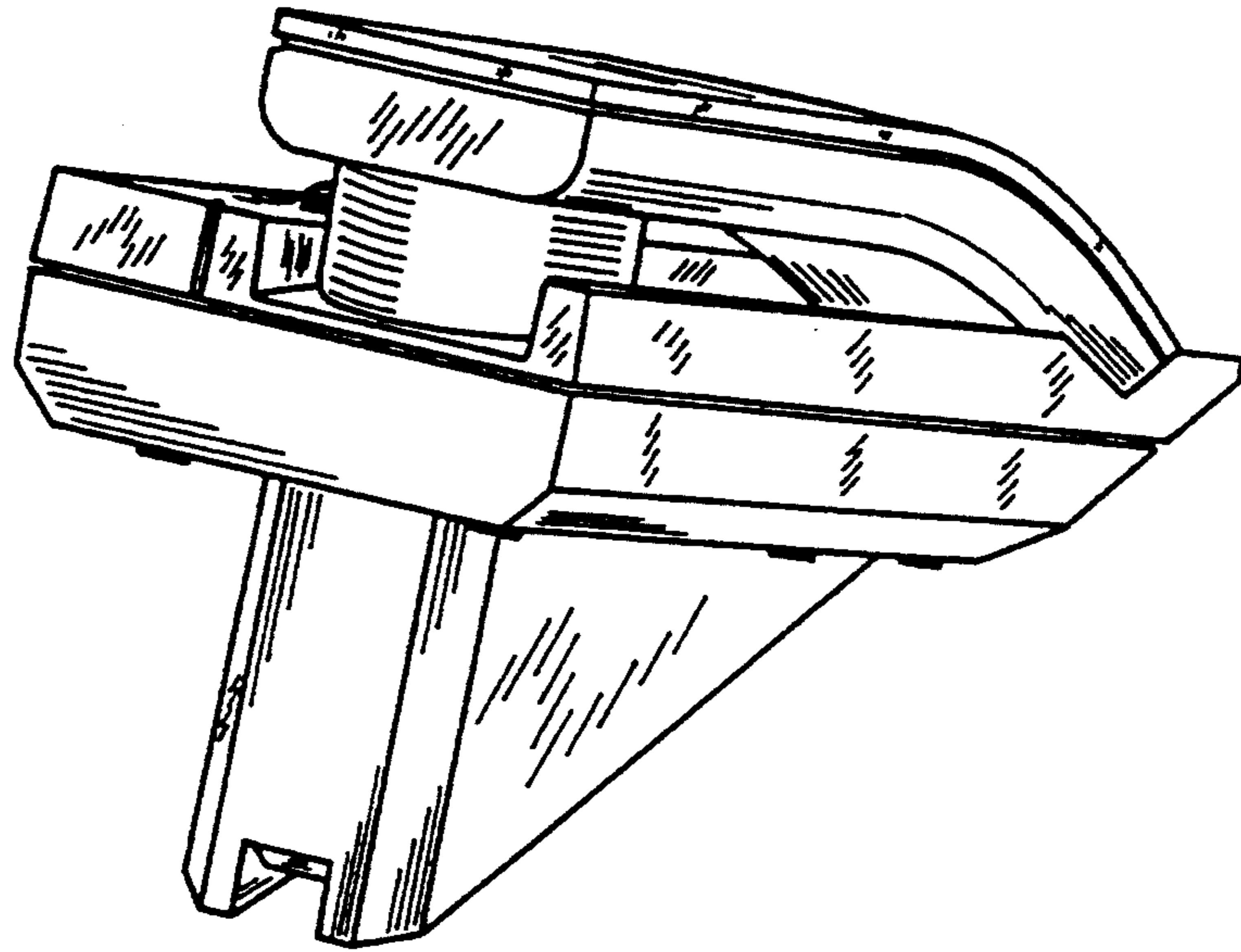

Fig. 6

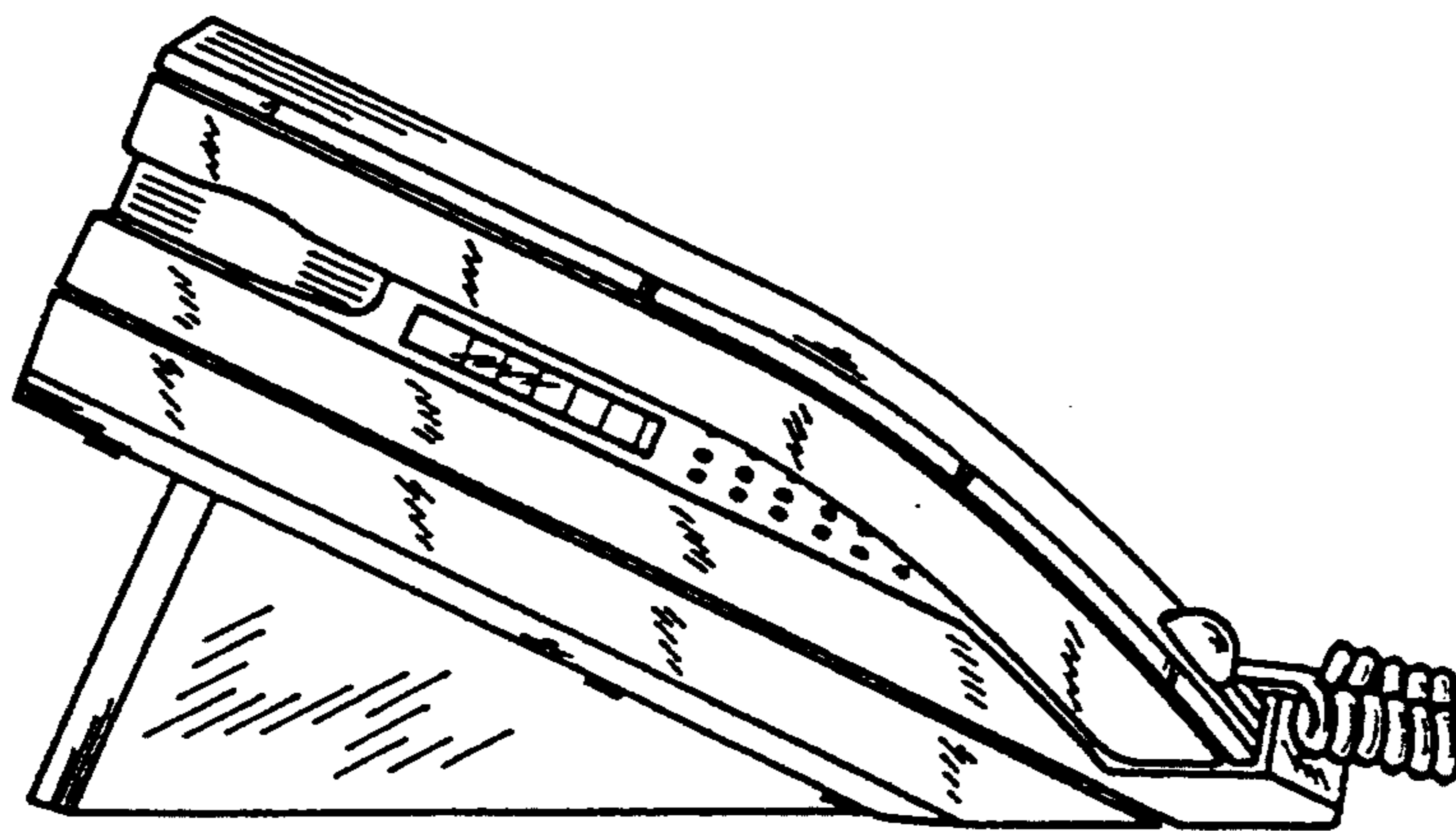

Fig. 7

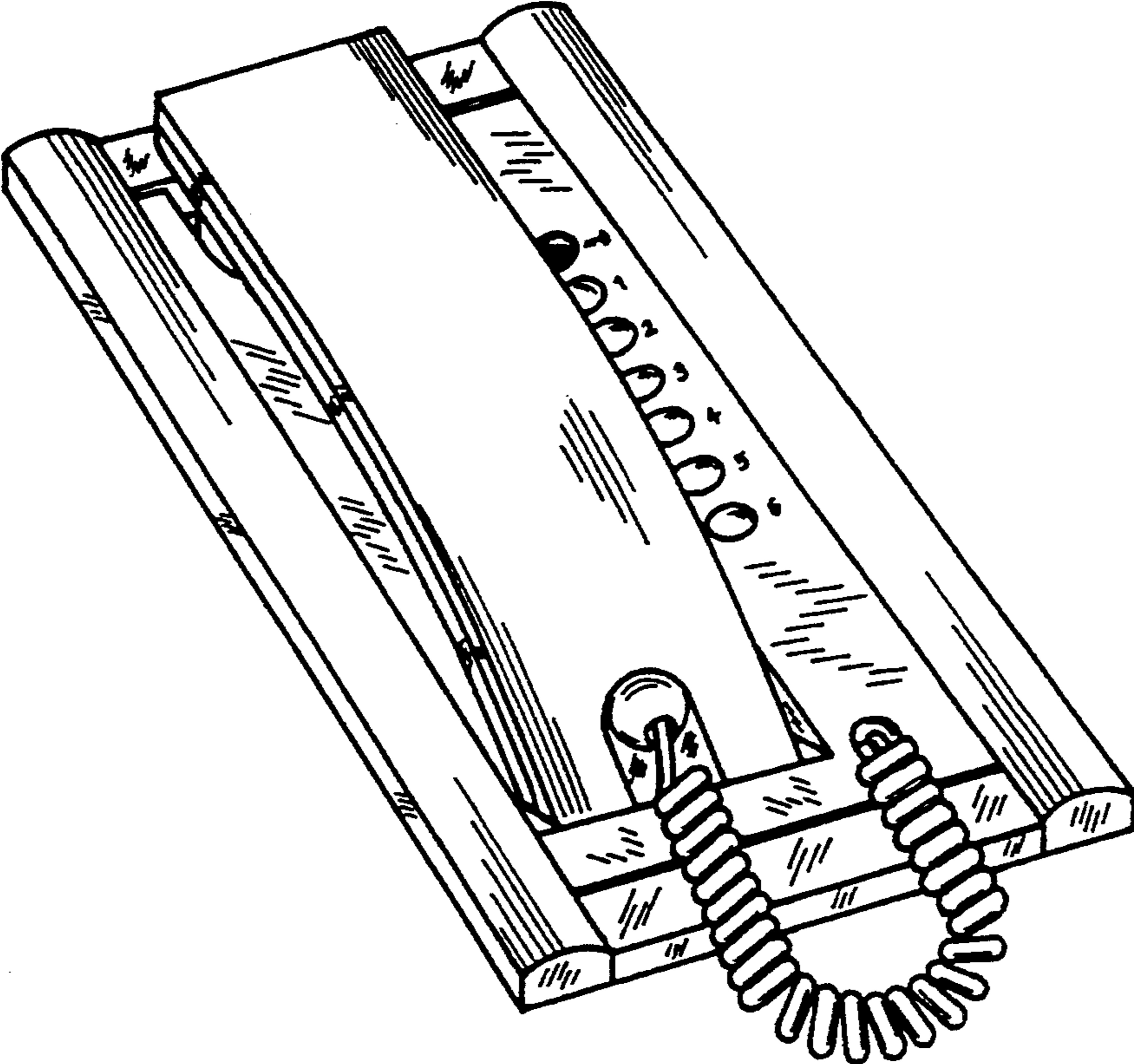

Fig. 8

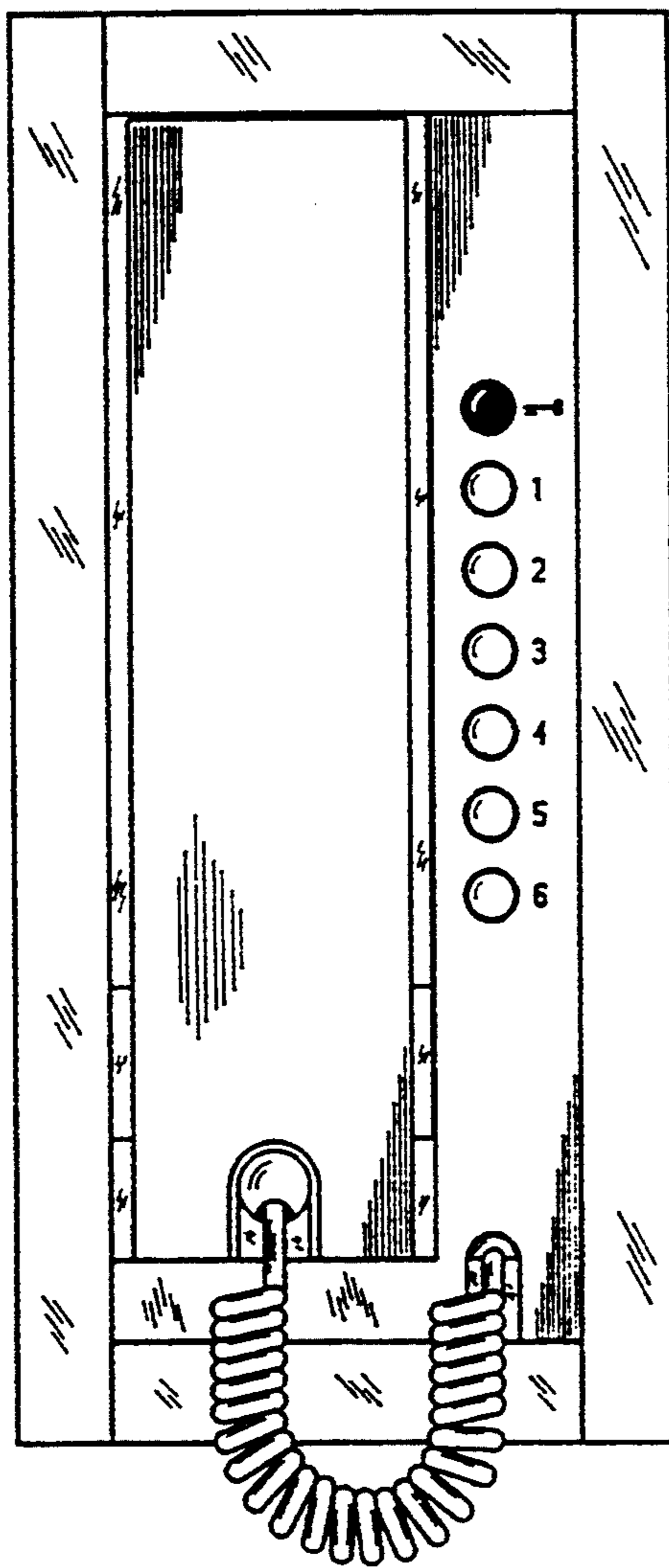

Fig. 9



Fig. 10

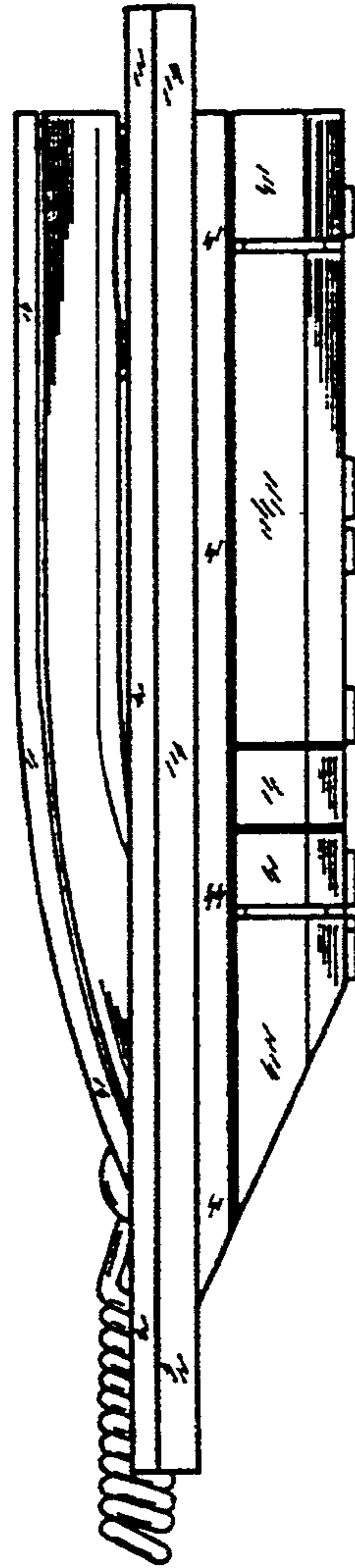

Fig. 11

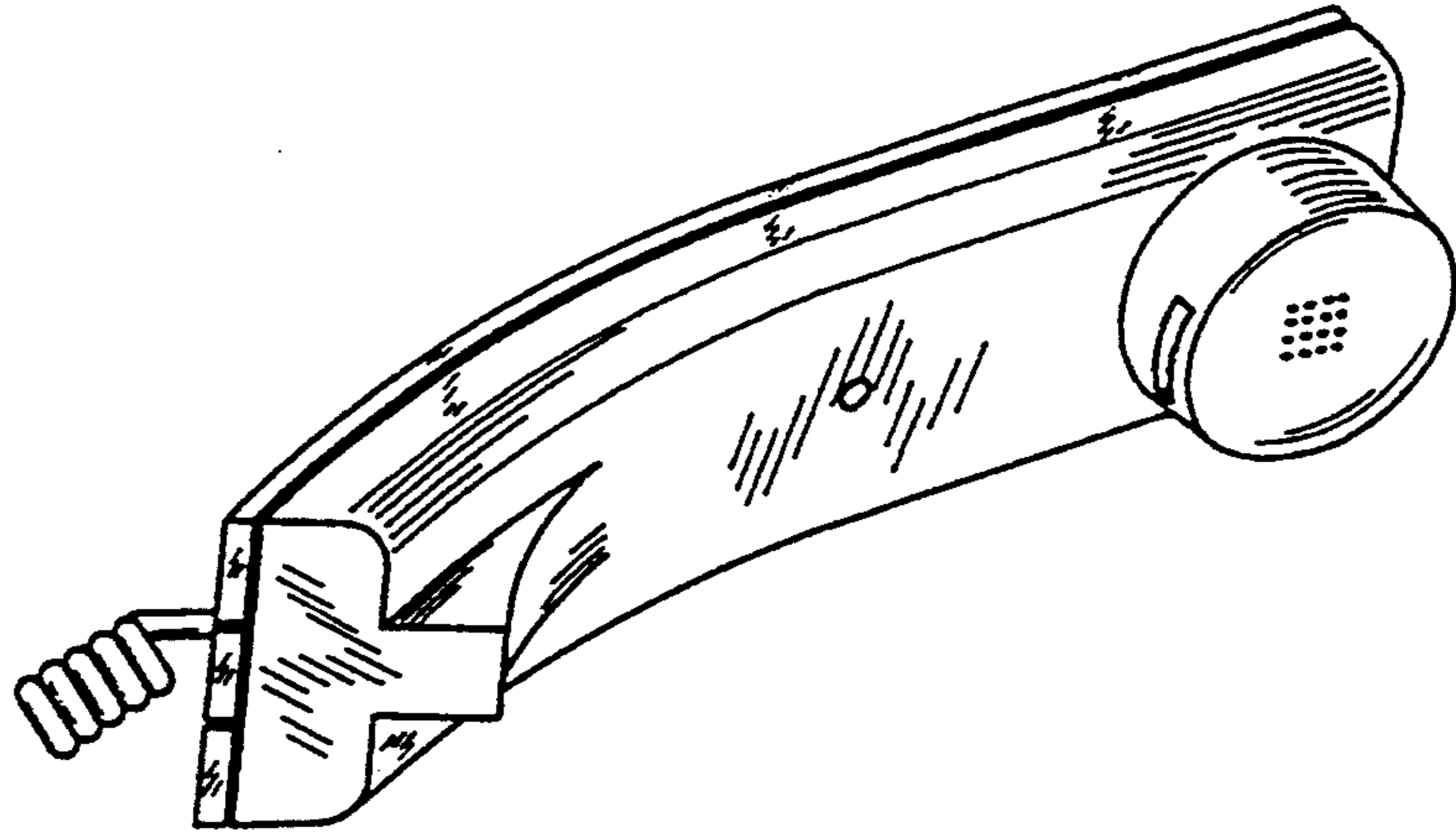

Fig. 12

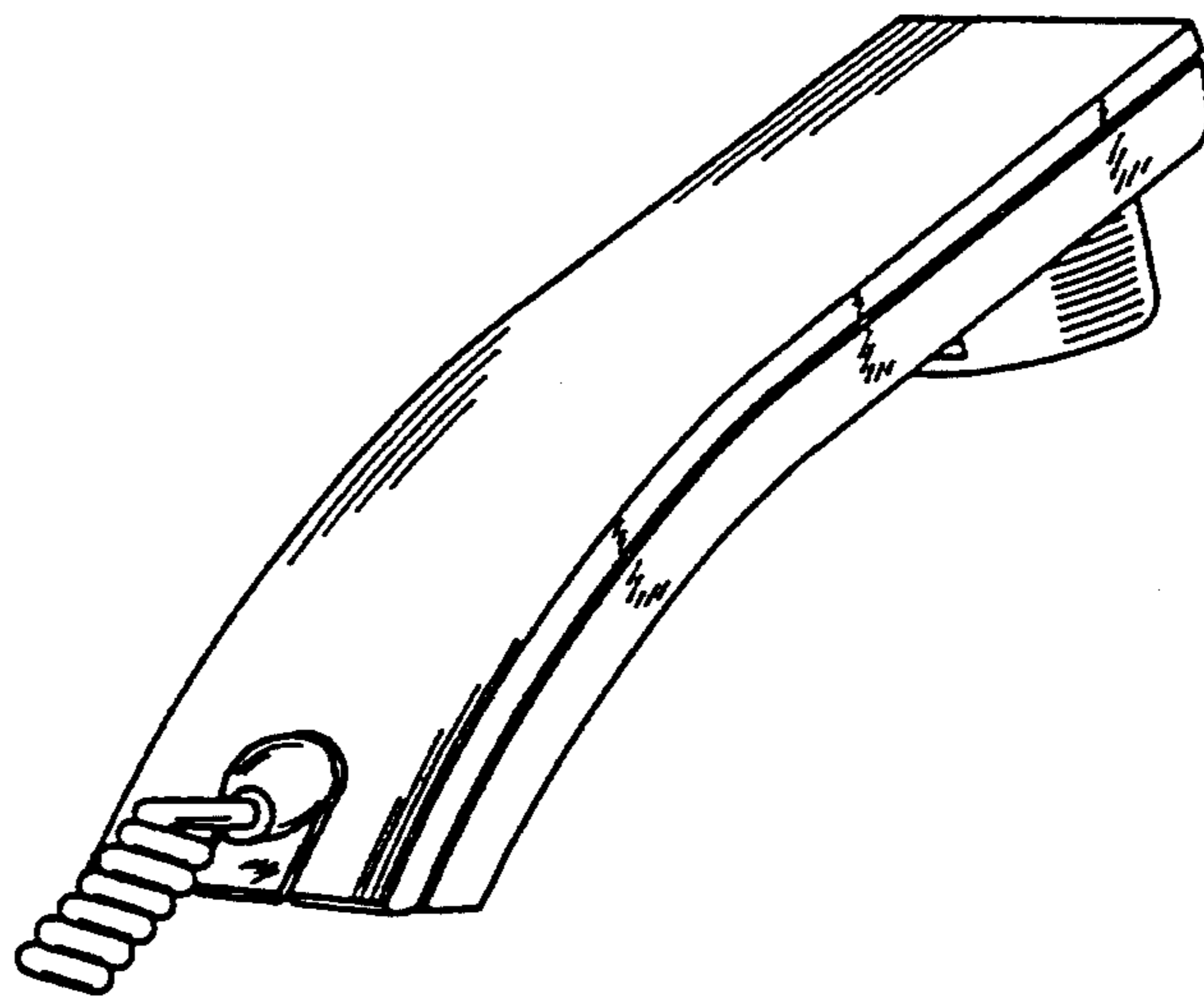

Fig. 13



Fig. 14