



US00D355170S

United States Patent [19]

[11] Patent Number: **Des. 355,170**

Mizusugi et al.

[45] Date of Patent: **** Feb. 7, 1995**

[54] **COMPUTER**

[75] Inventors: **Kanji Mizusugi, Mie; Kensho Tsuji, Nara; Hidetoshi Tamaki, Nara; Mitsuo Kawa, Nara, all of Japan**

[73] Assignee: **Sharp Kabushiki Kaisha, Osaka, Japan**

[**] Term: **14 Years**

[21] Appl. No.: **14,780**

[22] Filed: **Nov. 2, 1993**

[30] Foreign Application Priority Data

Jun. 24, 1993 [JP] Japan 5-19414

[52] U.S. Cl. **D14/100**

[58] Field of Search D14/100, 101, 106, 113, D14/115, 124-127; D18/1, 7; 345/104, 156, 168, 173, 901-905; 361/679-686; 364/708.1, 709.04, 709.12

[56] References Cited

U.S. PATENT DOCUMENTS

- D. 343,831 2/1994 Spoeth D14/106
- D. 345,347 3/1994 Yamazaki D14/106
- 5,100,098 3/1992 Hawkins D14/113 X
- 5,103,376 4/1992 Blonder D14/106 X

*Primary Examiner—Freda S. Nunn
Attorney, Agent, or Firm—Nixon & Vanderhye*

[57] CLAIM

The ornamental design for a computer, as shown and described.

DESCRIPTION

FIG. 1 is a top front and right side perspective view of a computer according to the present invention;
 FIG. 2 is a top plan view thereof;
 FIG. 3 is a front elevational view thereof;
 FIG. 4 is a right side elevational view thereof;
 FIG. 5 is a rear elevational view thereof;
 FIG. 6 is a left side elevational view thereof;
 FIG. 7 is a bottom plan view thereof;
 FIG. 8 is a top front and right side perspective view thereof similar to that shown in FIG. 1 with the cover shown open and folded back;
 FIG. 9 is a top plan view thereof;
 FIG. 10 is a front elevational view thereof;
 FIG. 11 is a right side elevational view thereof;
 FIG. 12 is a rear elevational view thereof;
 FIG. 13 is a left side elevational view thereof;
 FIG. 14 is a bottom plan view thereof; and,
 FIG. 15 is a reduced top front and right side perspective view thereof with the cover shown open and the computer shown in a standing position.

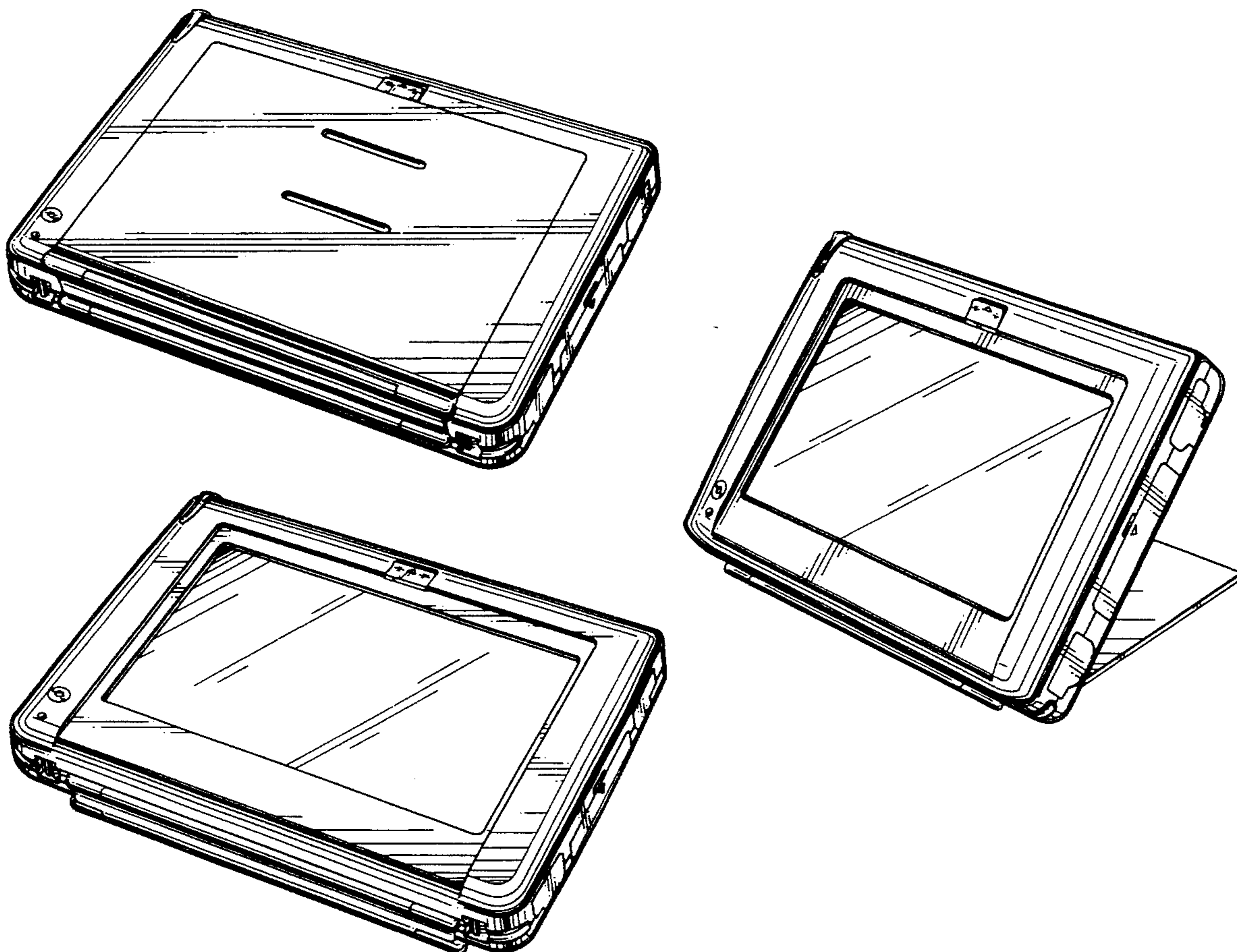

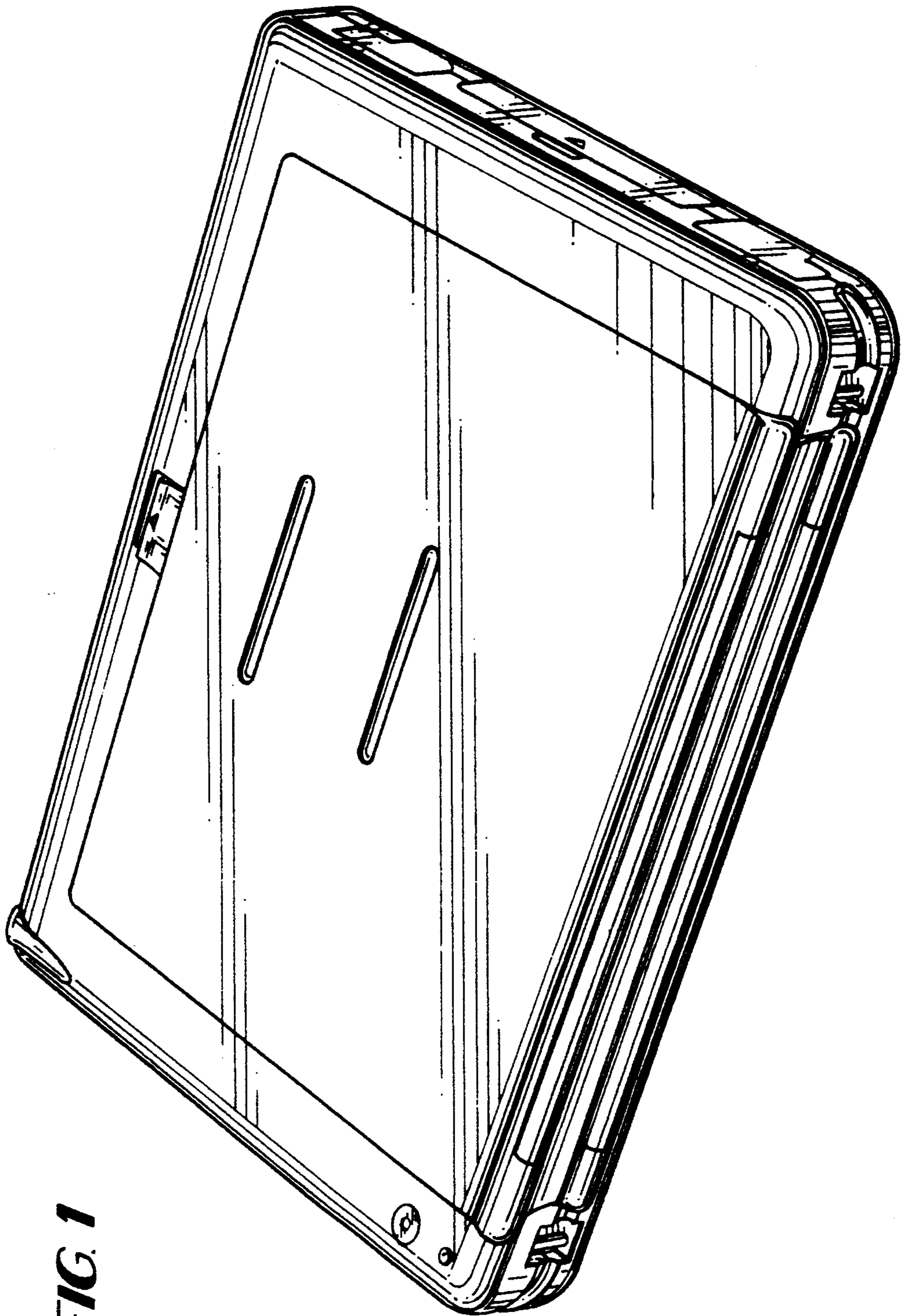

FIG. 1

FIG. 2

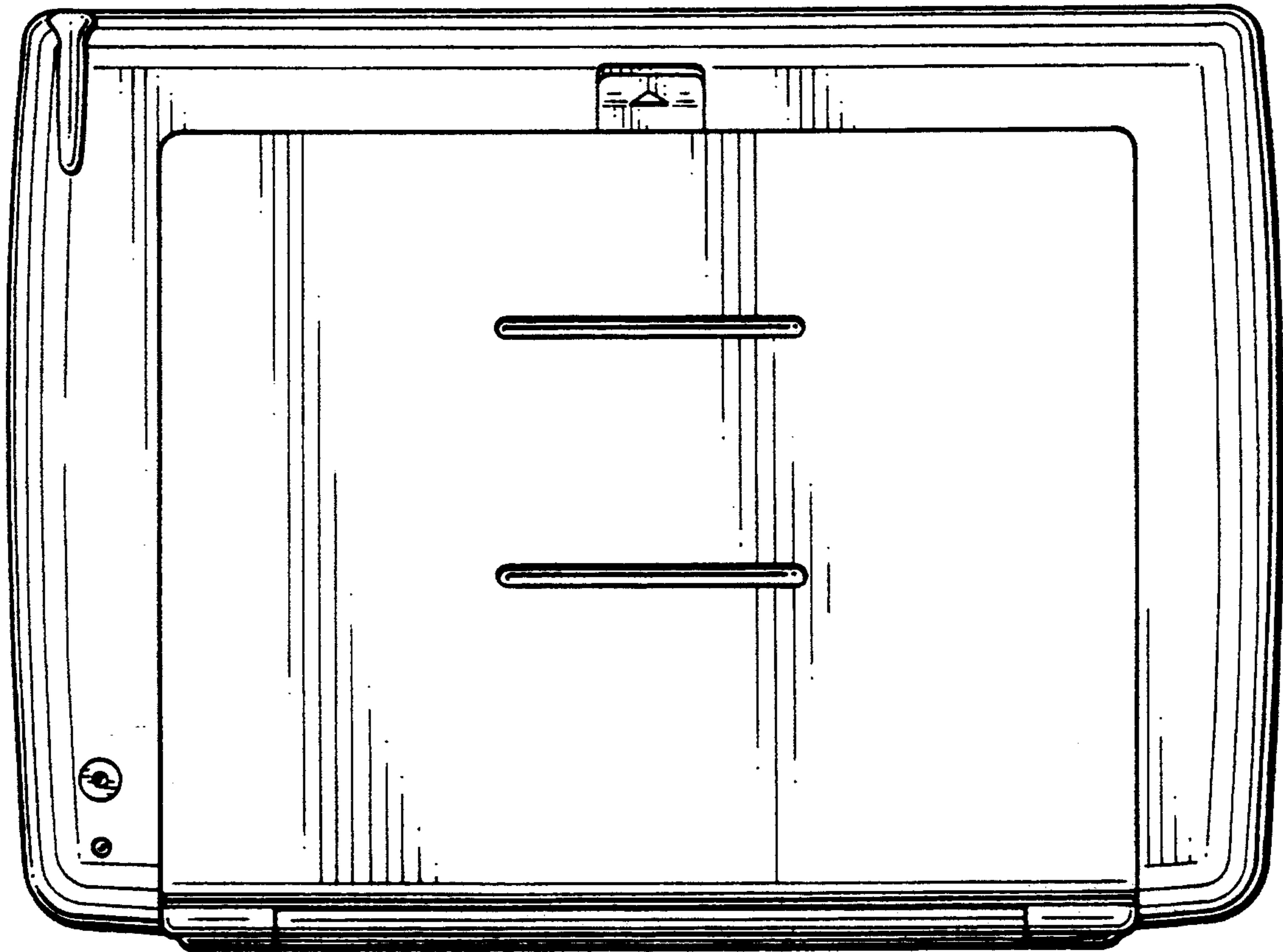

FIG. 3

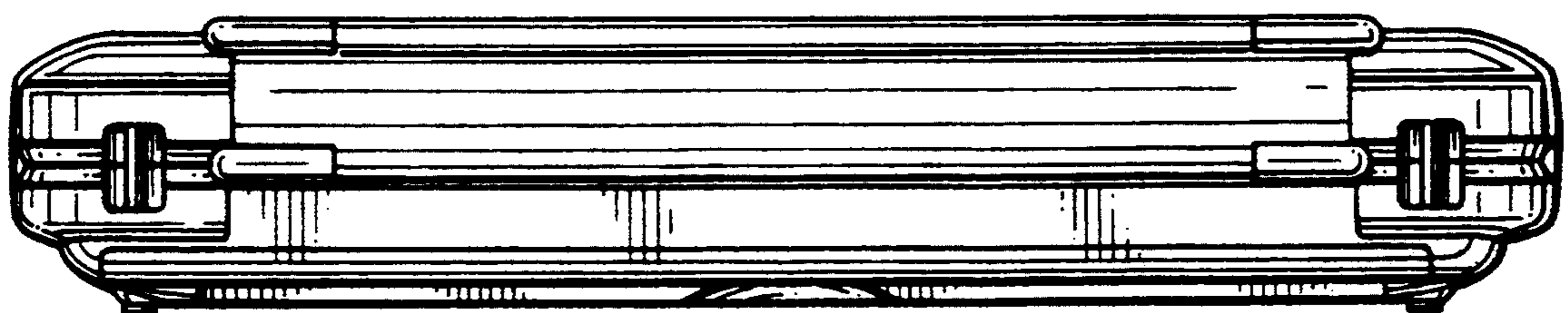

FIG. 4

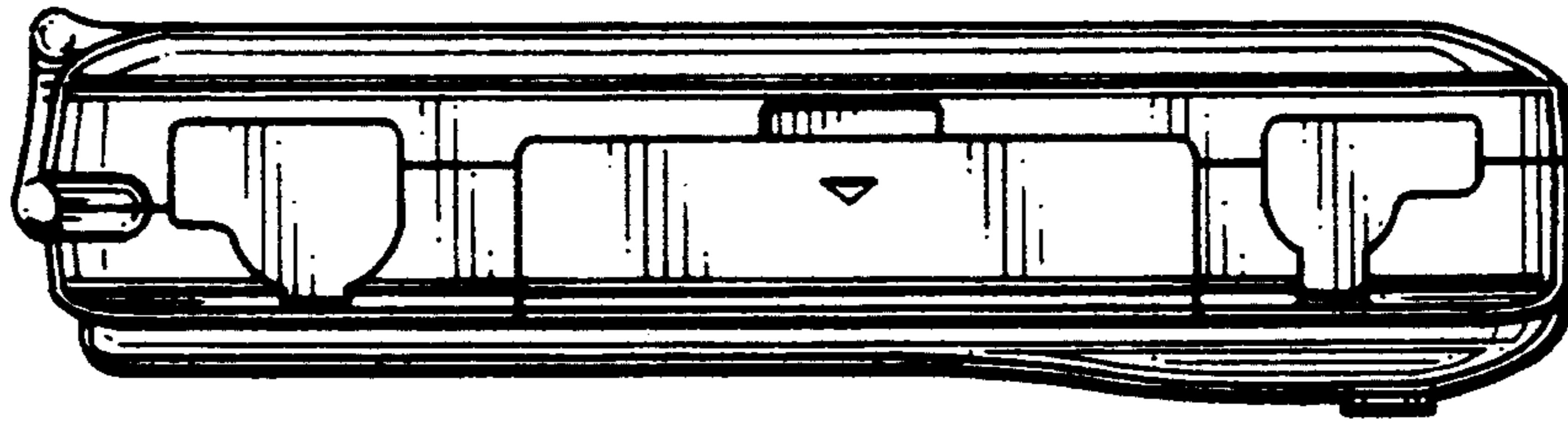

FIG. 5

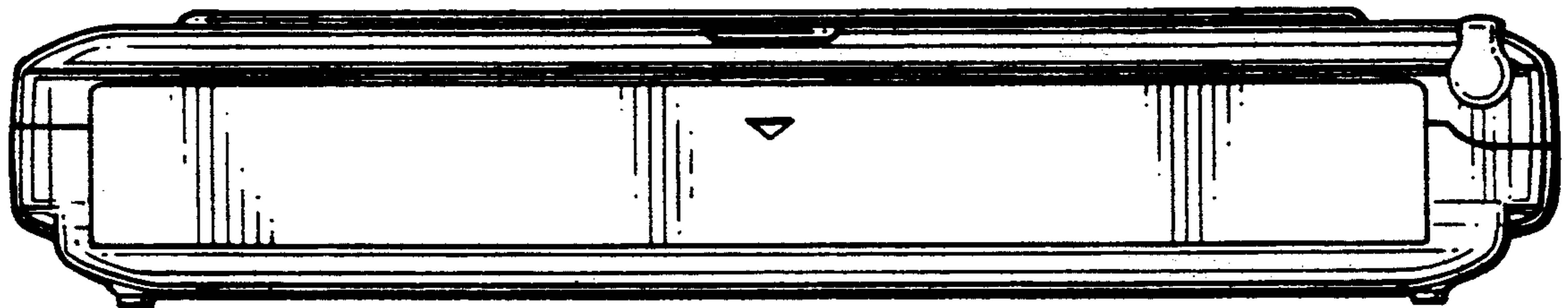

FIG. 6

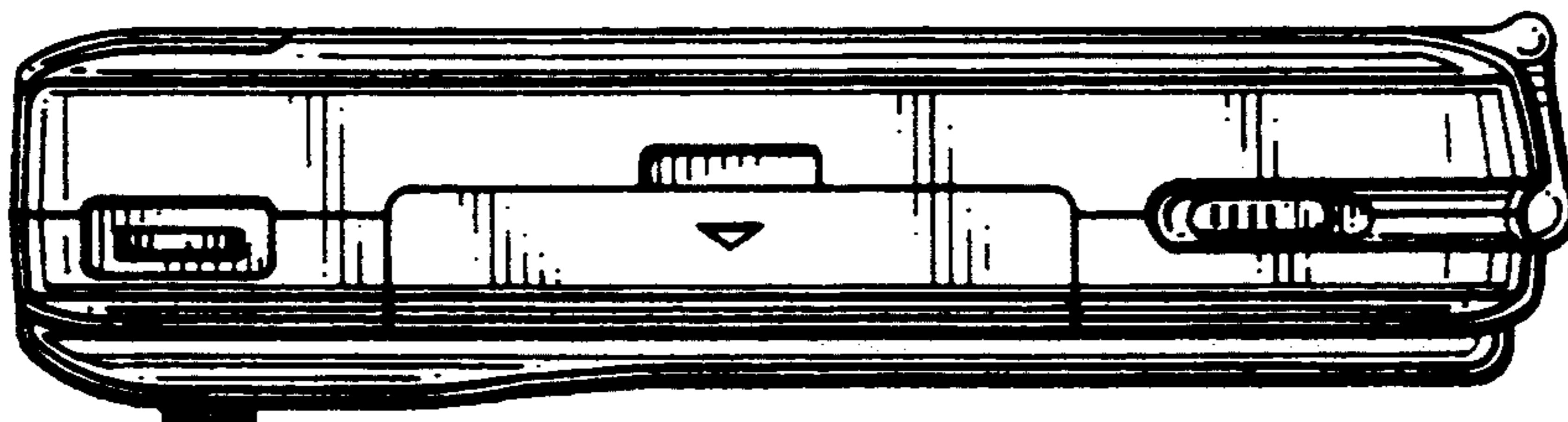
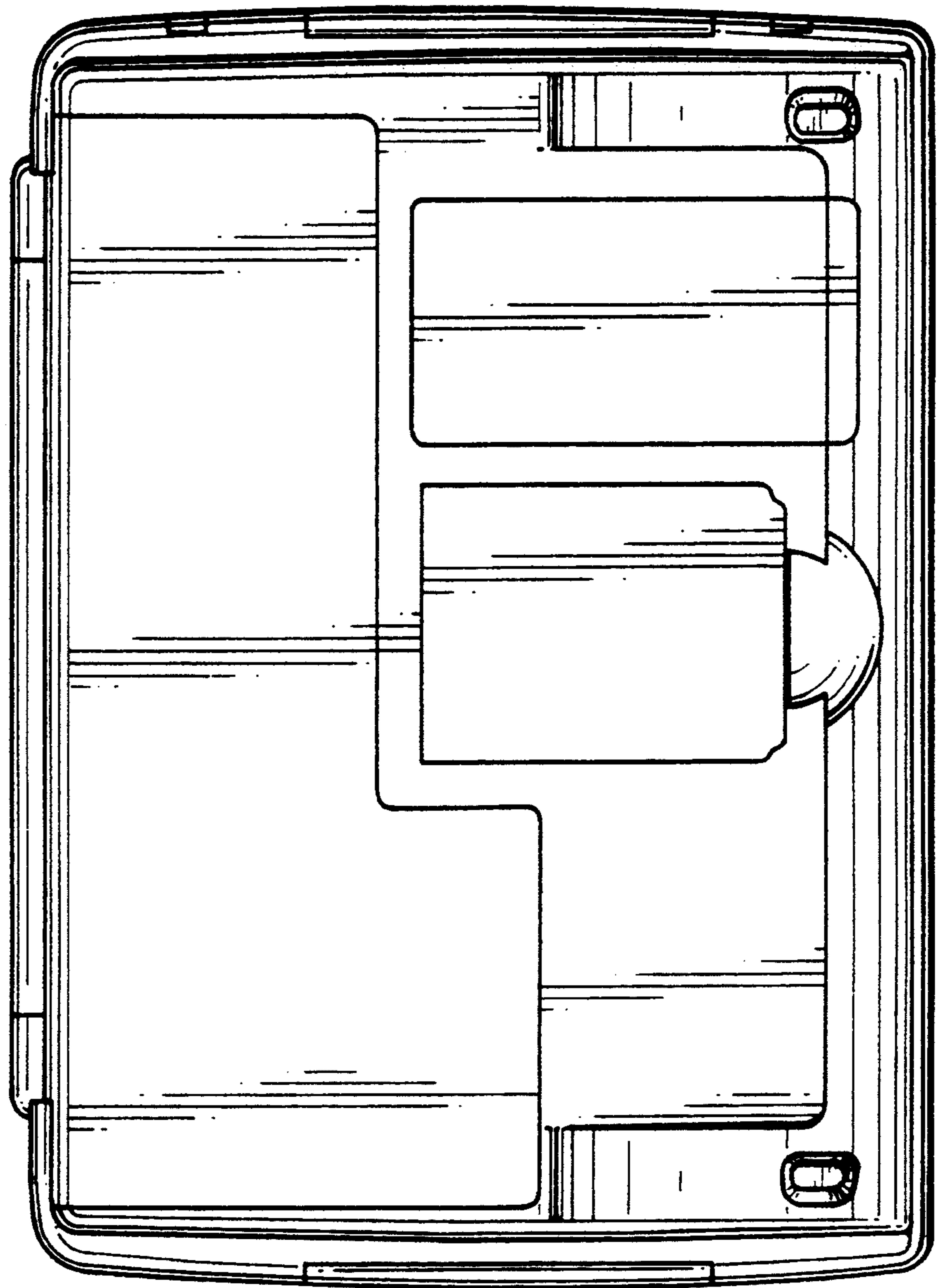

FIG. 7



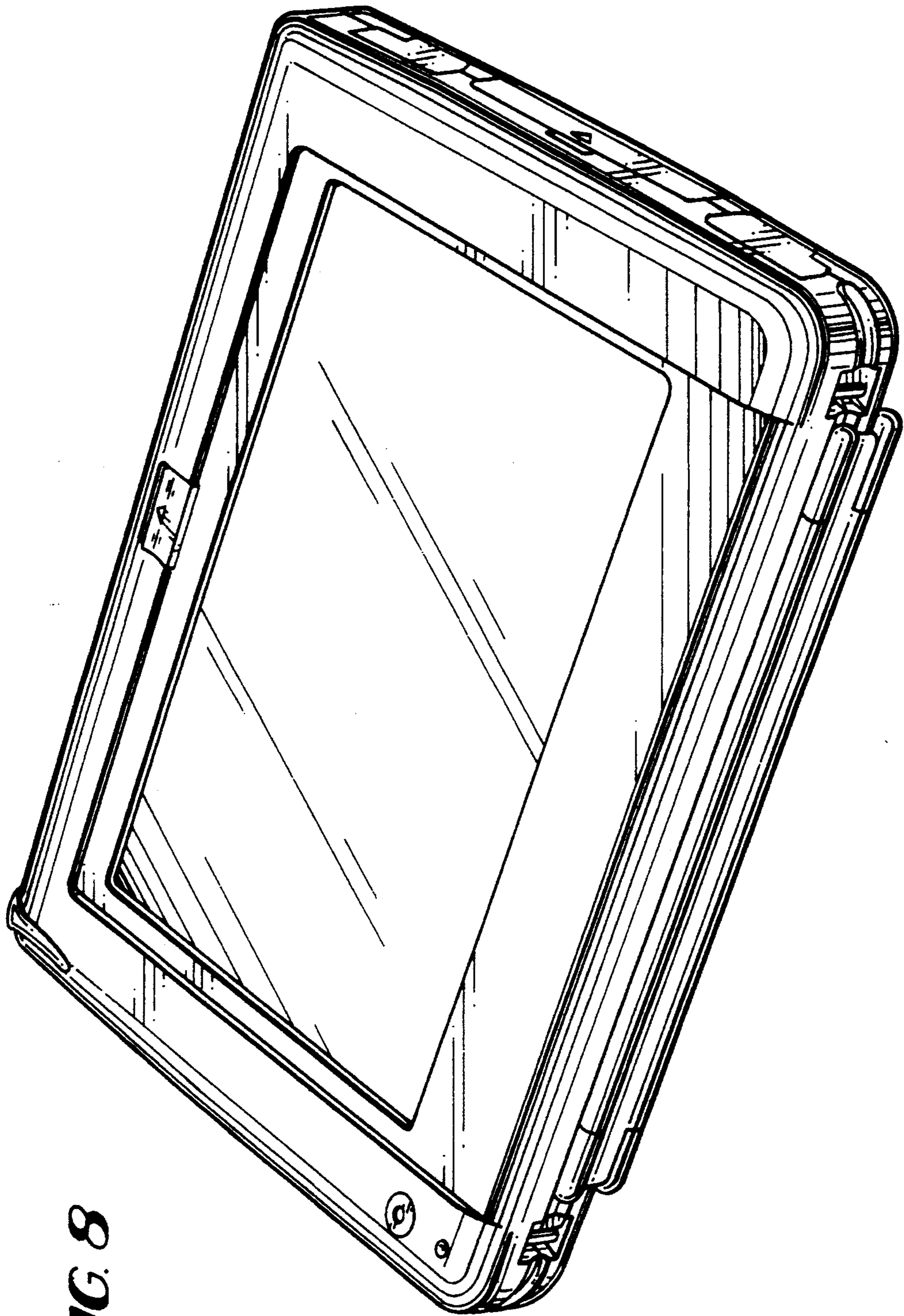

FIG. 8

FIG. 9

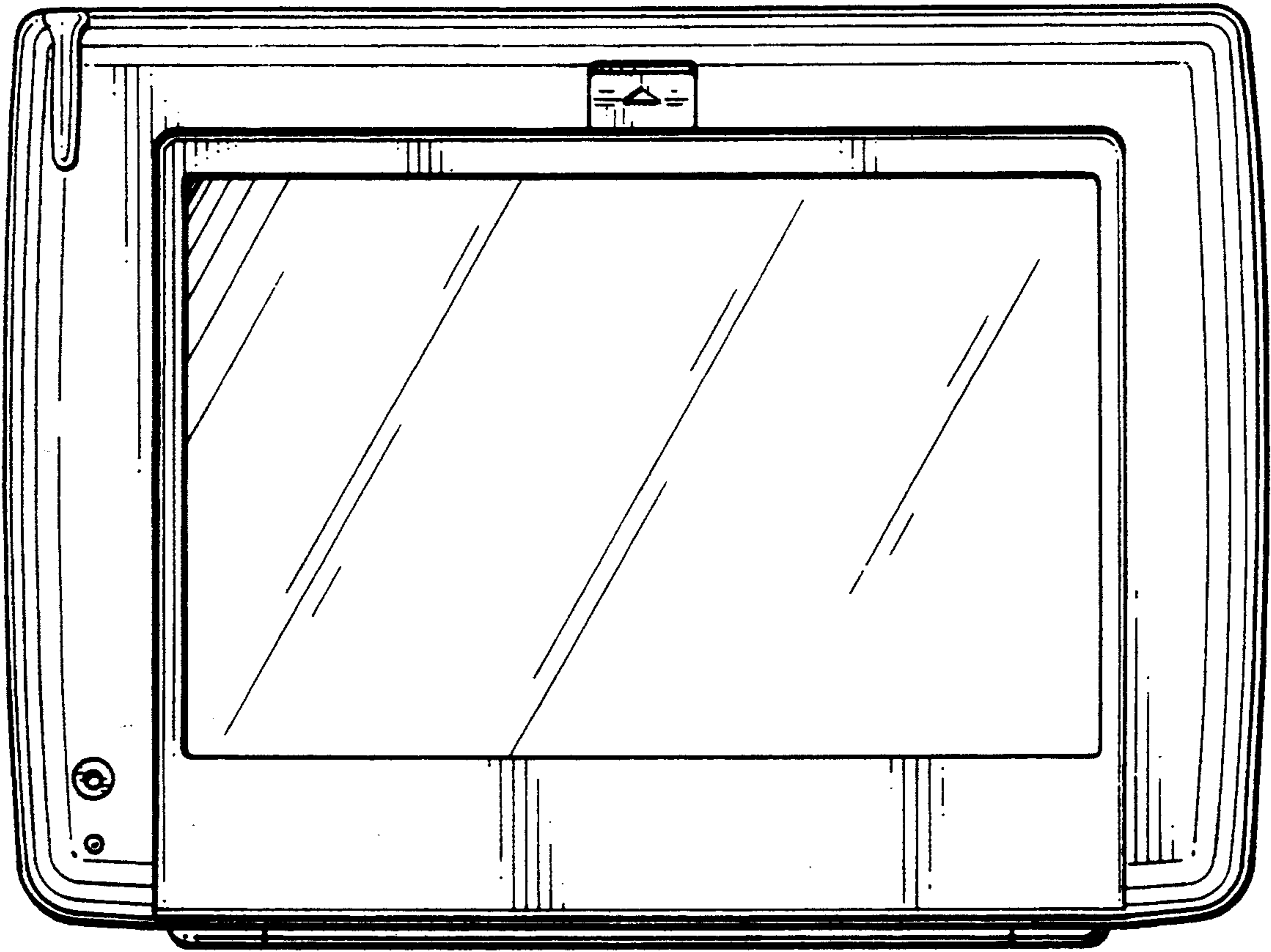

FIG. 10

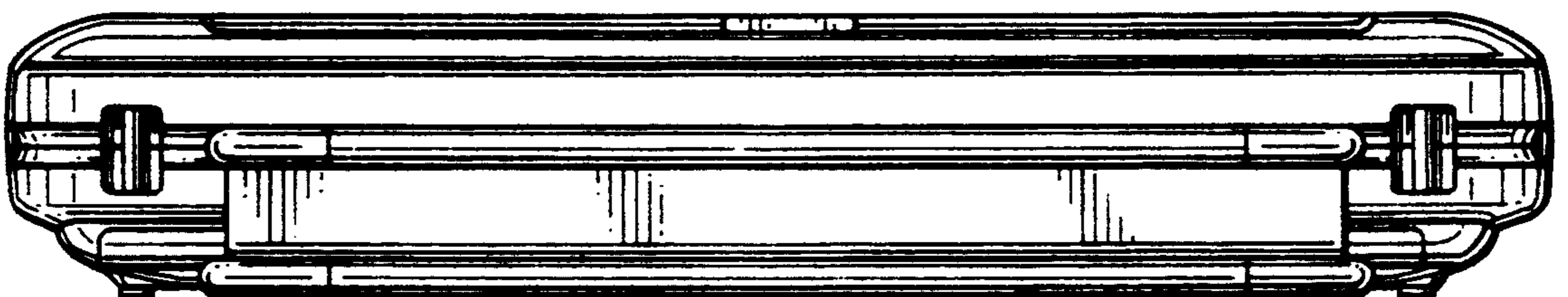

FIG. 11

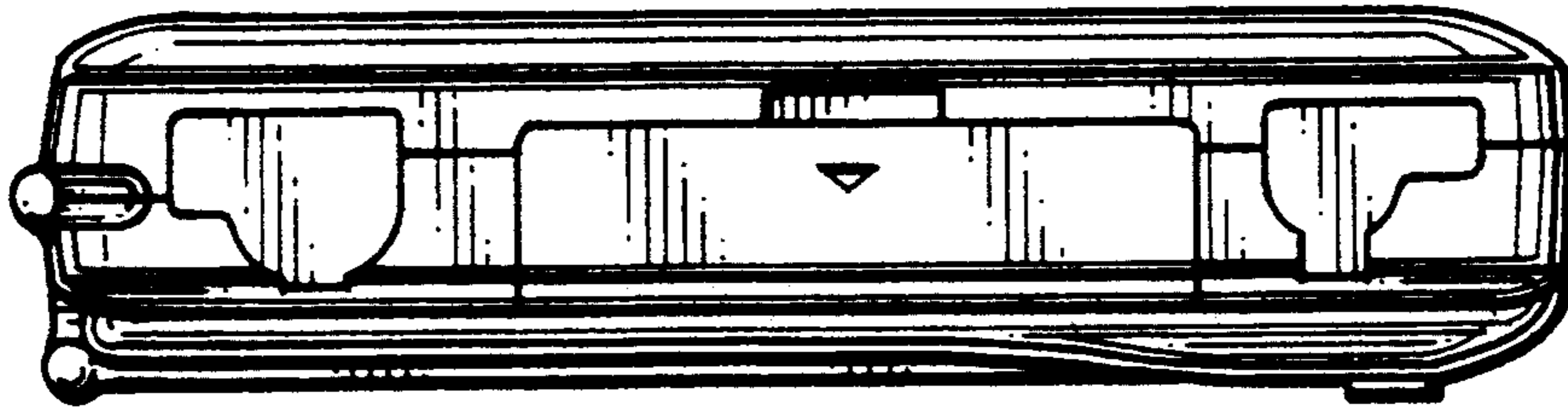

FIG. 12

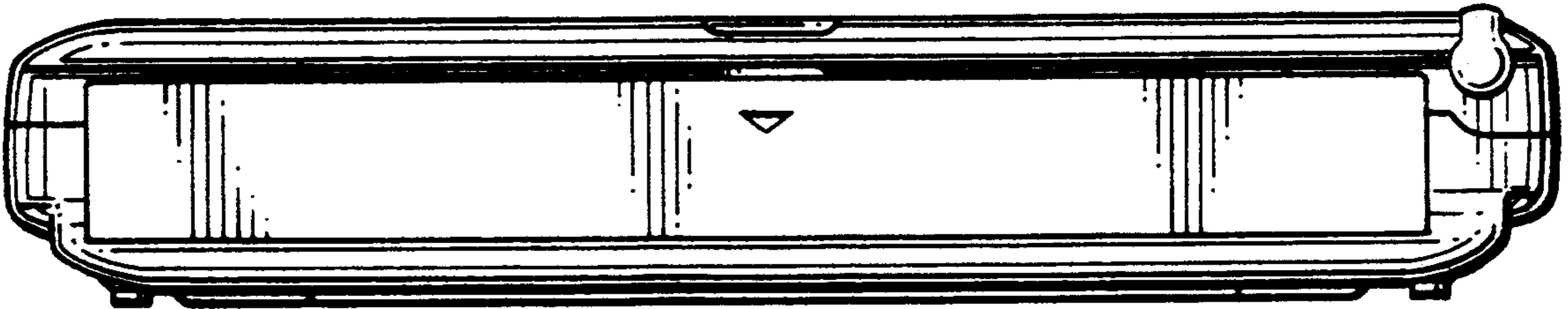

FIG. 13

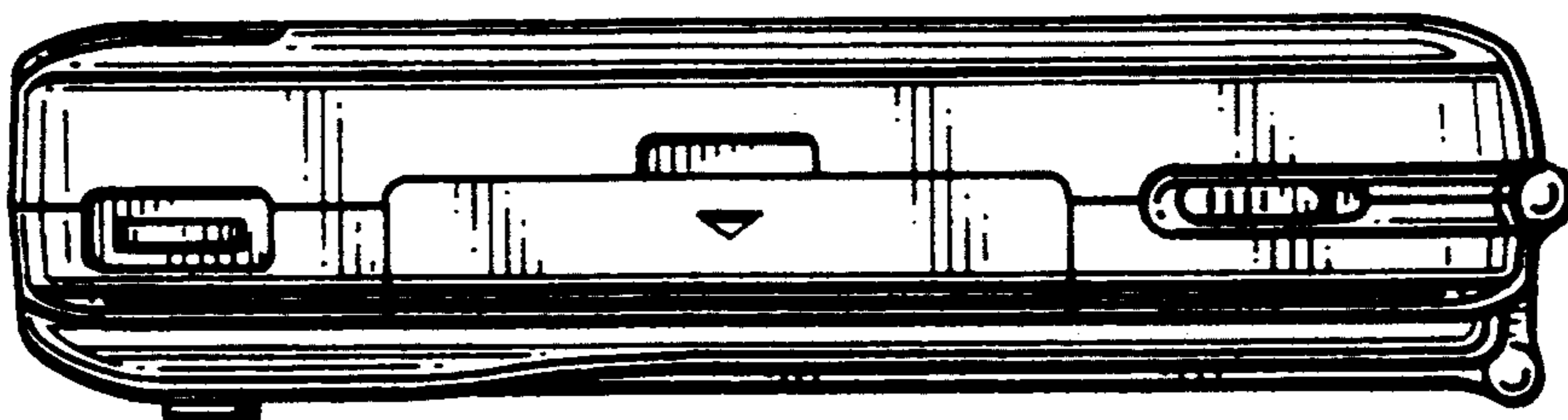
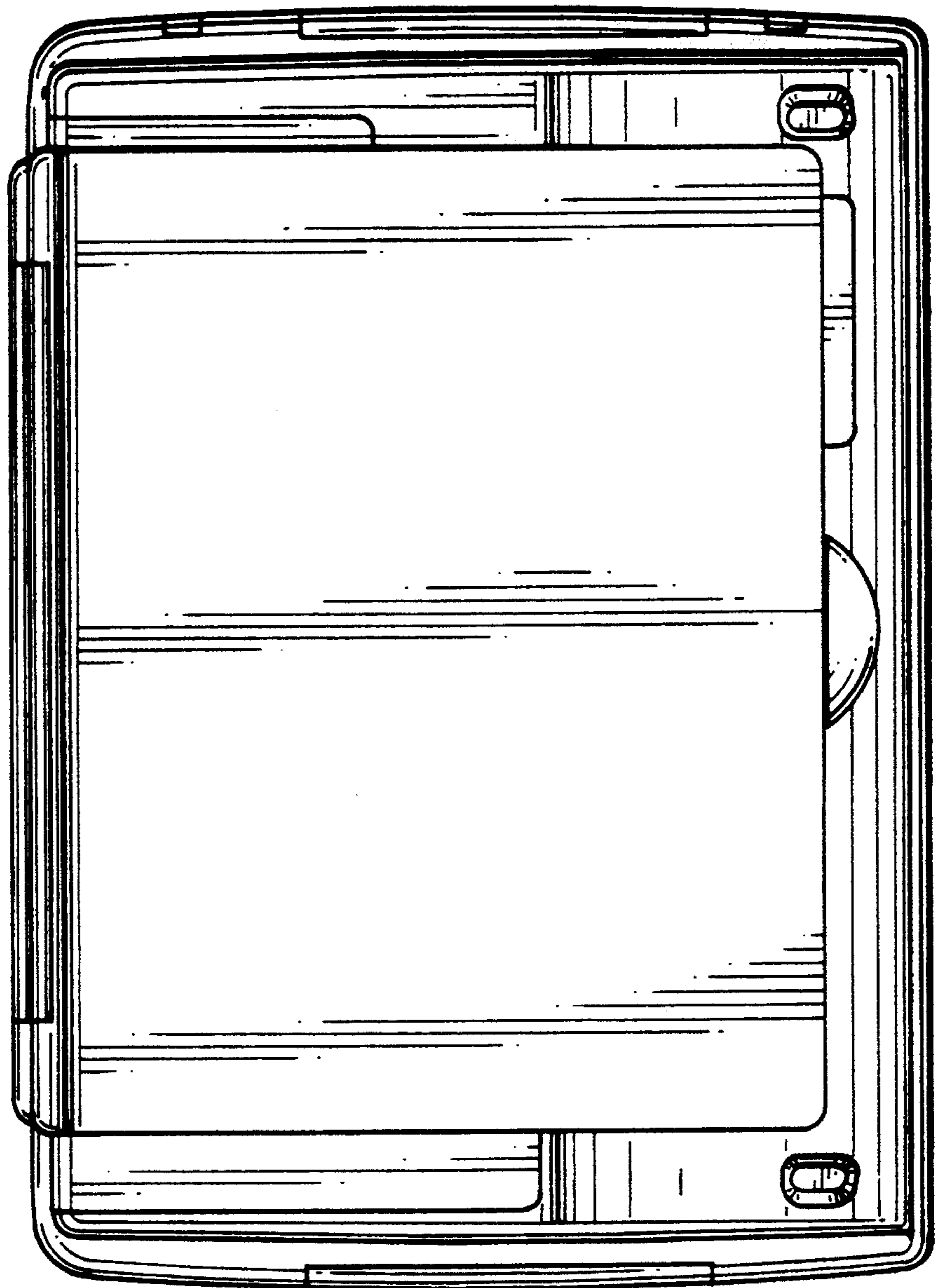

FIG. 14



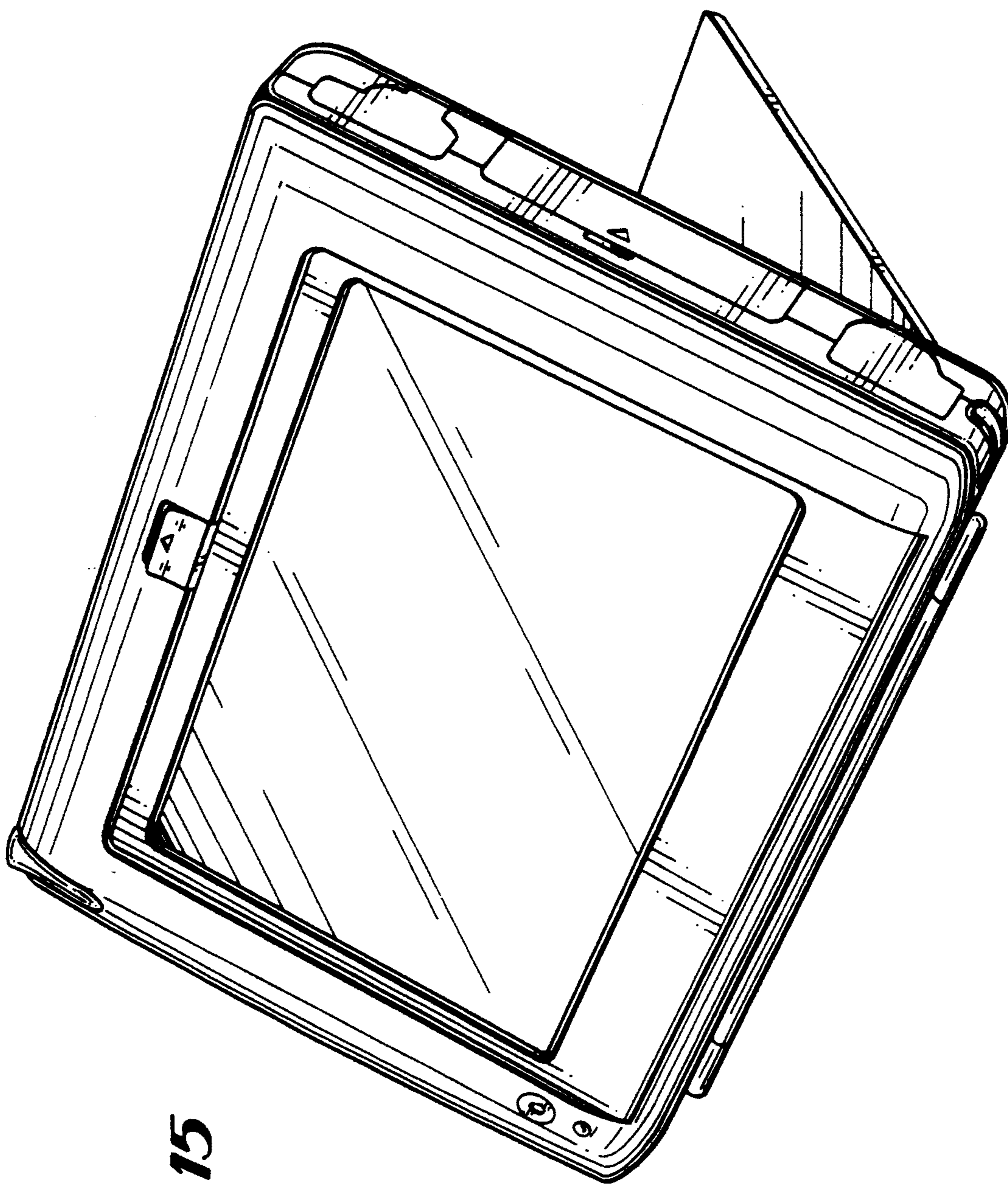

FIG. 15