



US00D355078S

United States Patent [19]

[11] Patent Number: **Des. 355,078**

Saiger

[45] Date of Patent: **** Feb. 7, 1995**

[54] **CHAIR FRAME**

[75] Inventor: **Herbert C. Saiger, Troy, Ohio**

[73] Assignee: **Crown Leisure Products, Inc., Owosso, Mich.**

[**] Term: **14 Years**

[21] Appl. No.: **825,172**

[22] Filed: **Jan. 24, 1992**

[52] U.S. Cl. **D6/370; D6/334**

[58] Field of Search **D6/334, 358, 370, 379, D6/381; 297/182, 232, 250.1, 281, 411.4, 452.35**

[56] **References Cited**

U.S. PATENT DOCUMENTS

- D. 320,894 10/1991 Pons D6/379 X
- D. 321,602 11/1991 Saiger D6/379
- D. 339,928 10/1993 Caldwell D6/370
- D. 340,365 10/1993 Hess D6/370

OTHER PUBLICATIONS

Interiors, Feb. 1989, p. 14, "Belmar-Circa 1961 Chair", left center of page.

Crown Leisure Products, Inc. Catalogue, 1987, Form No. W01-87-10M, pp. 28 and 29.

Primary Examiner—Wallace R. Burke

Assistant Examiner—Monica A. Hannon

Attorney, Agent, or Firm—Learman & McCulloch

[57] **CLAIM**

The ornamental design for a chair frame, as shown and described.

DESCRIPTION

FIG. 1 is a side elevational view;

FIG. 2 is a front elevational view;

FIG. 3 is a top plan view;

FIG. 4 is a rear elevational view;

FIG. 5 is a side elevational view of a modified embodiment of the invention;

FIG. 6 is a front elevational view thereof;

FIG. 7 is a top plan view thereof; and,

FIG. 8 is a rear elevational view thereof.

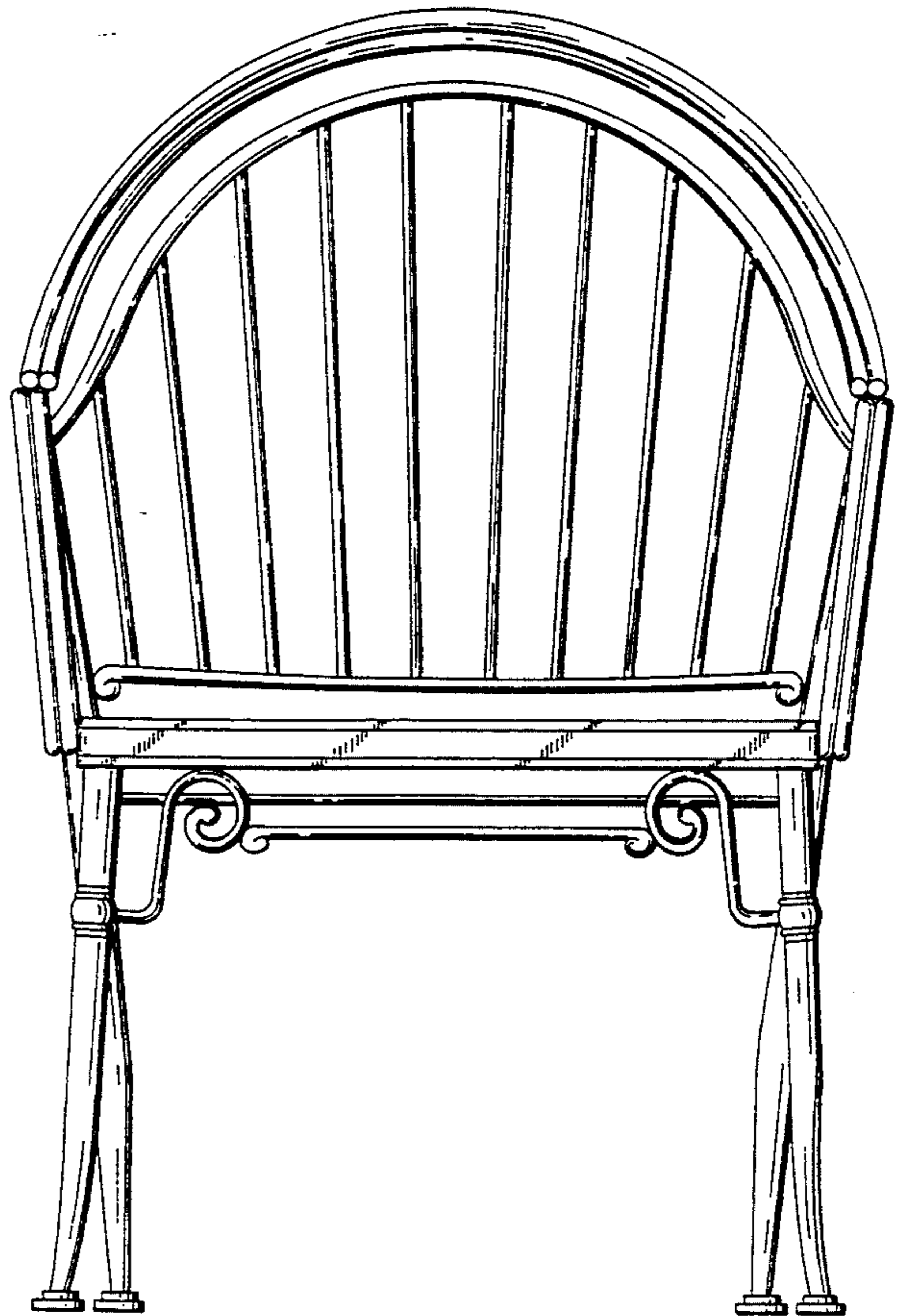
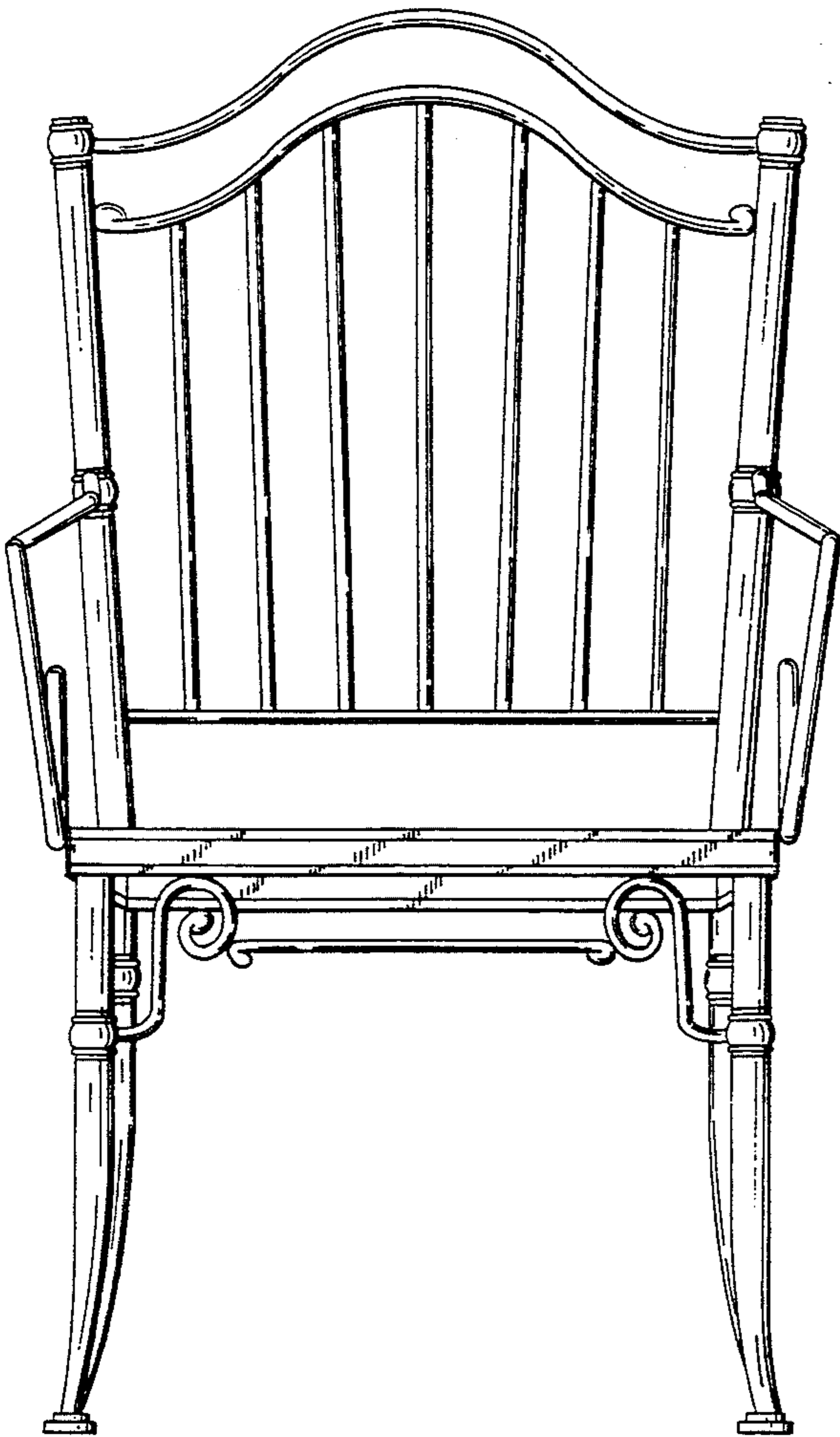

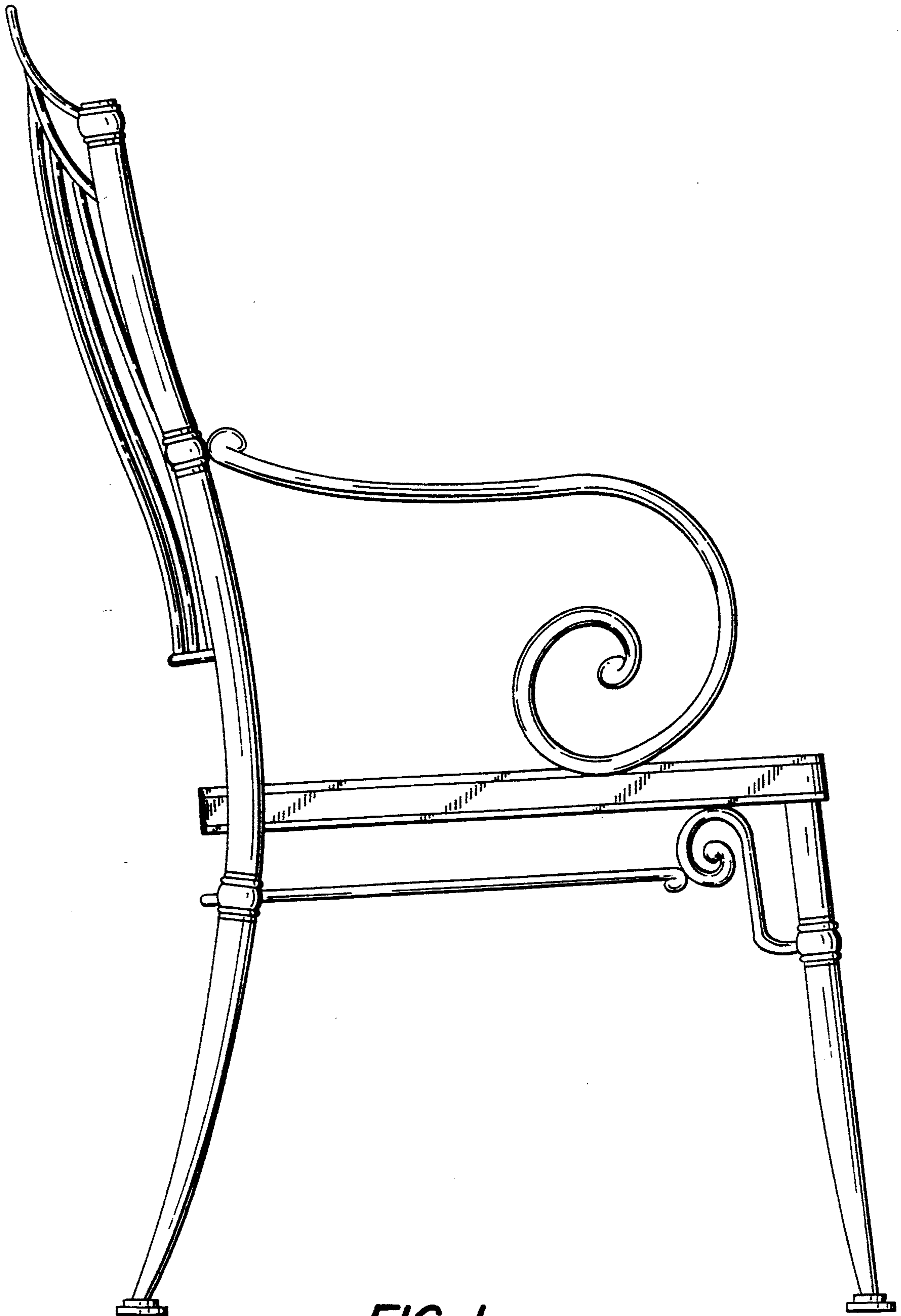

FIG-1

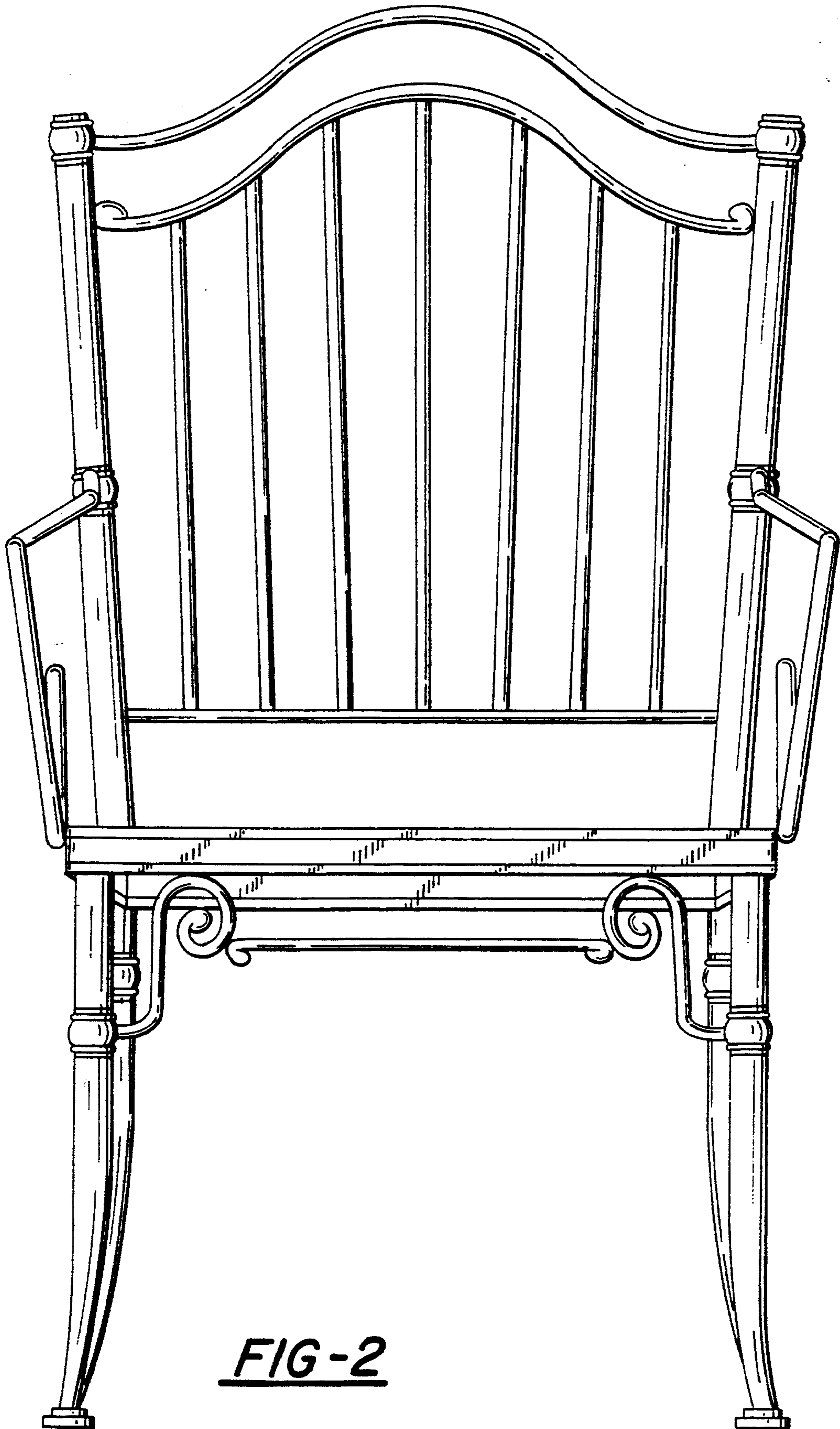

FIG-2

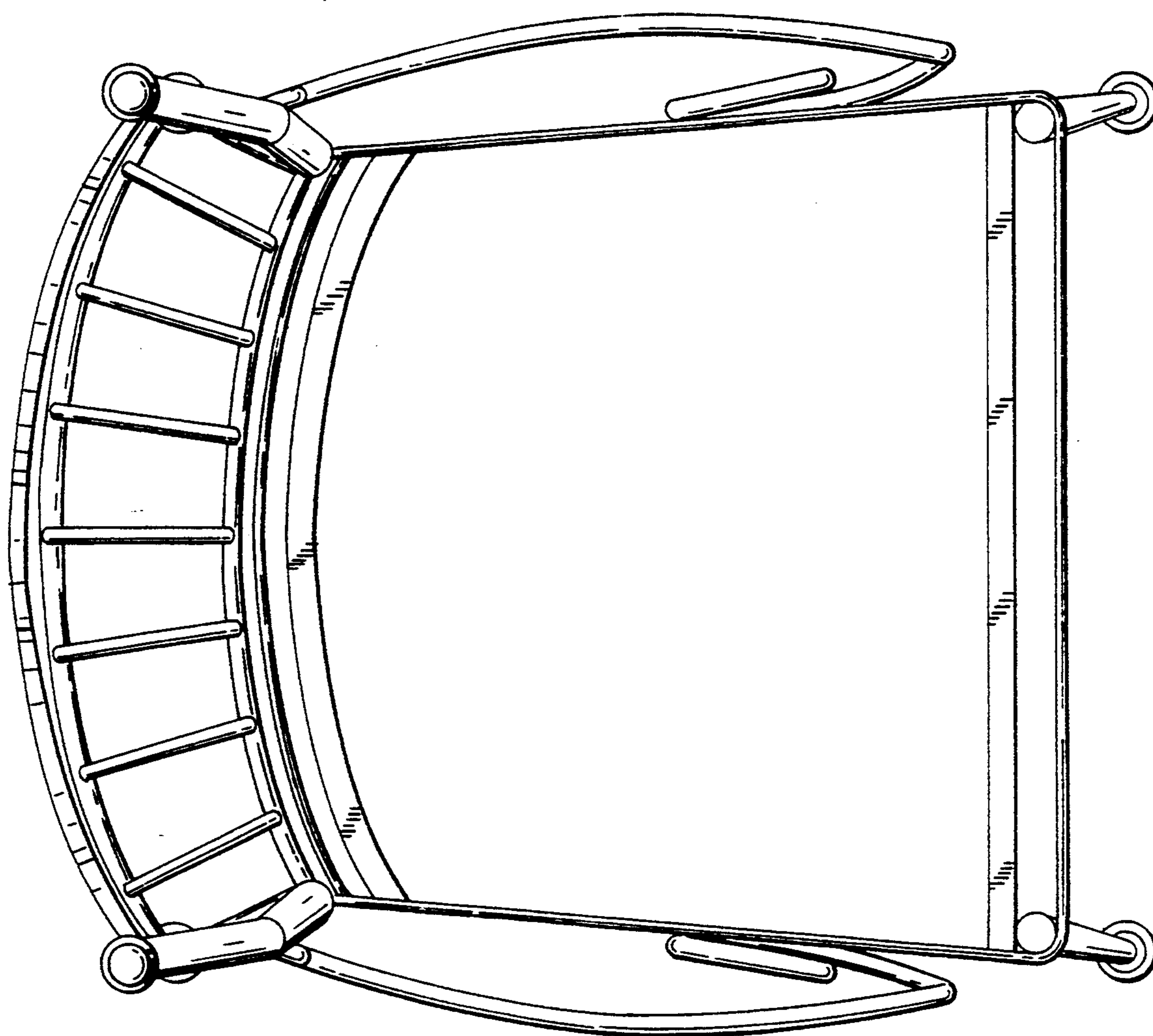

FIG-3

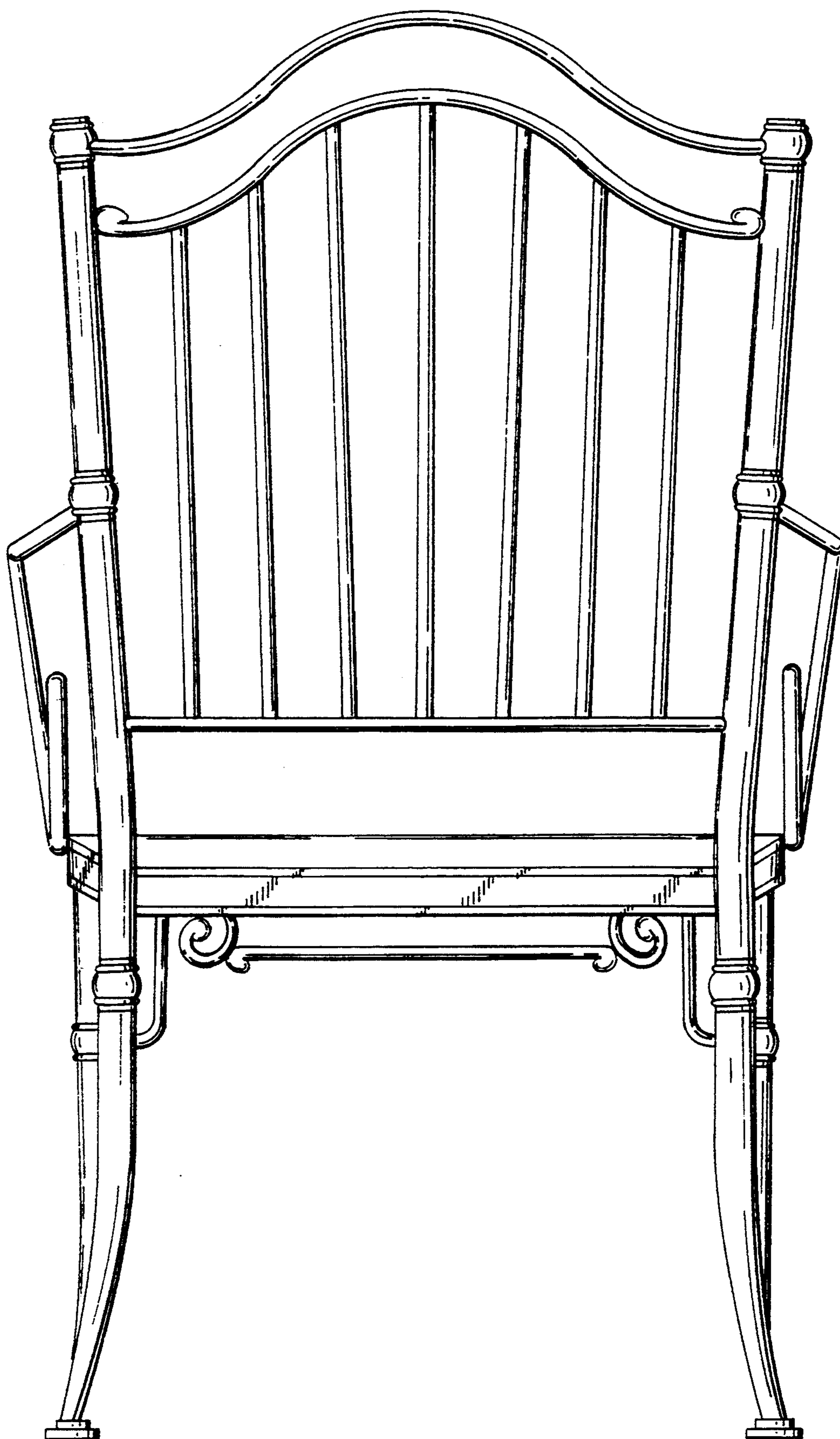

FIG - 4

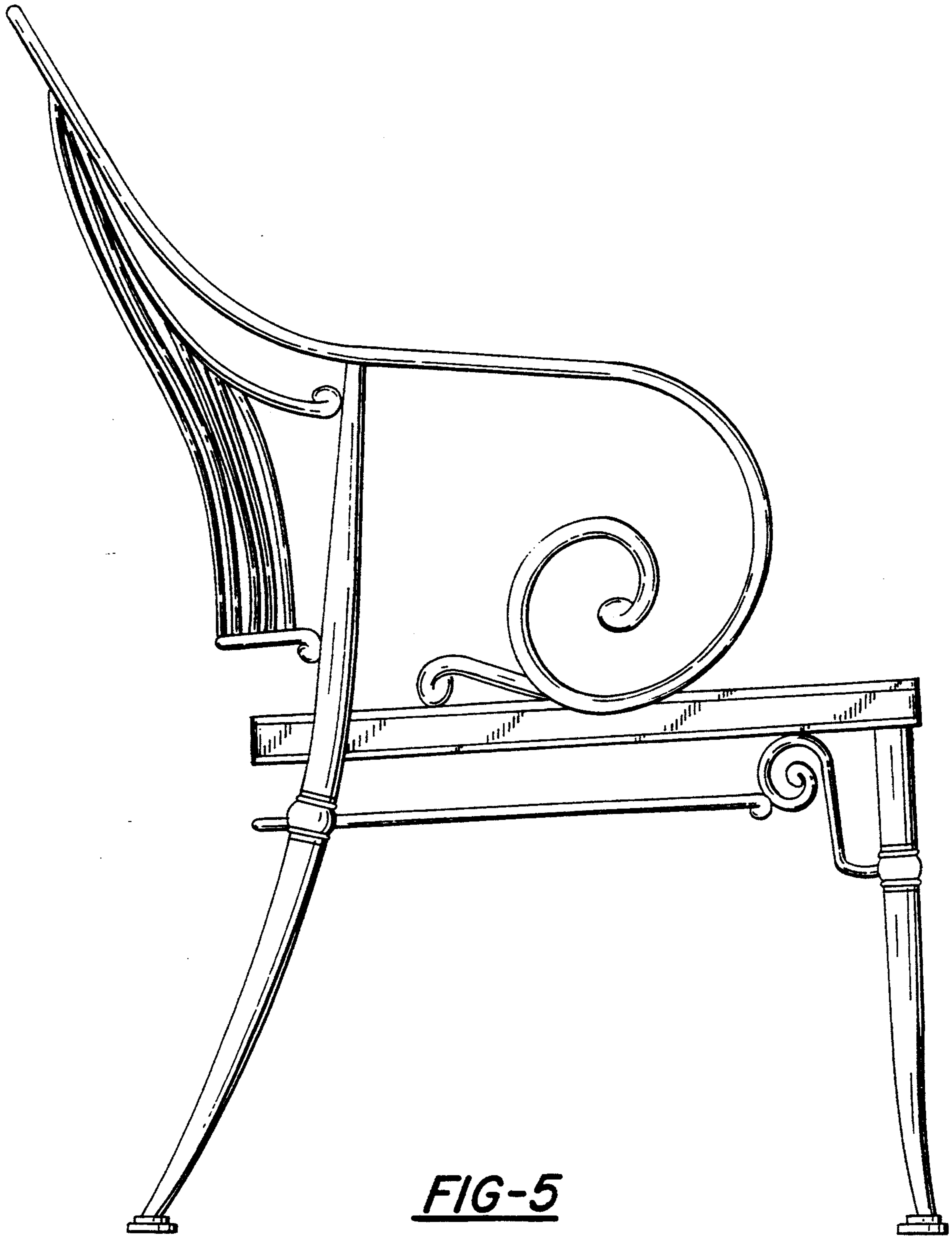

FIG-5

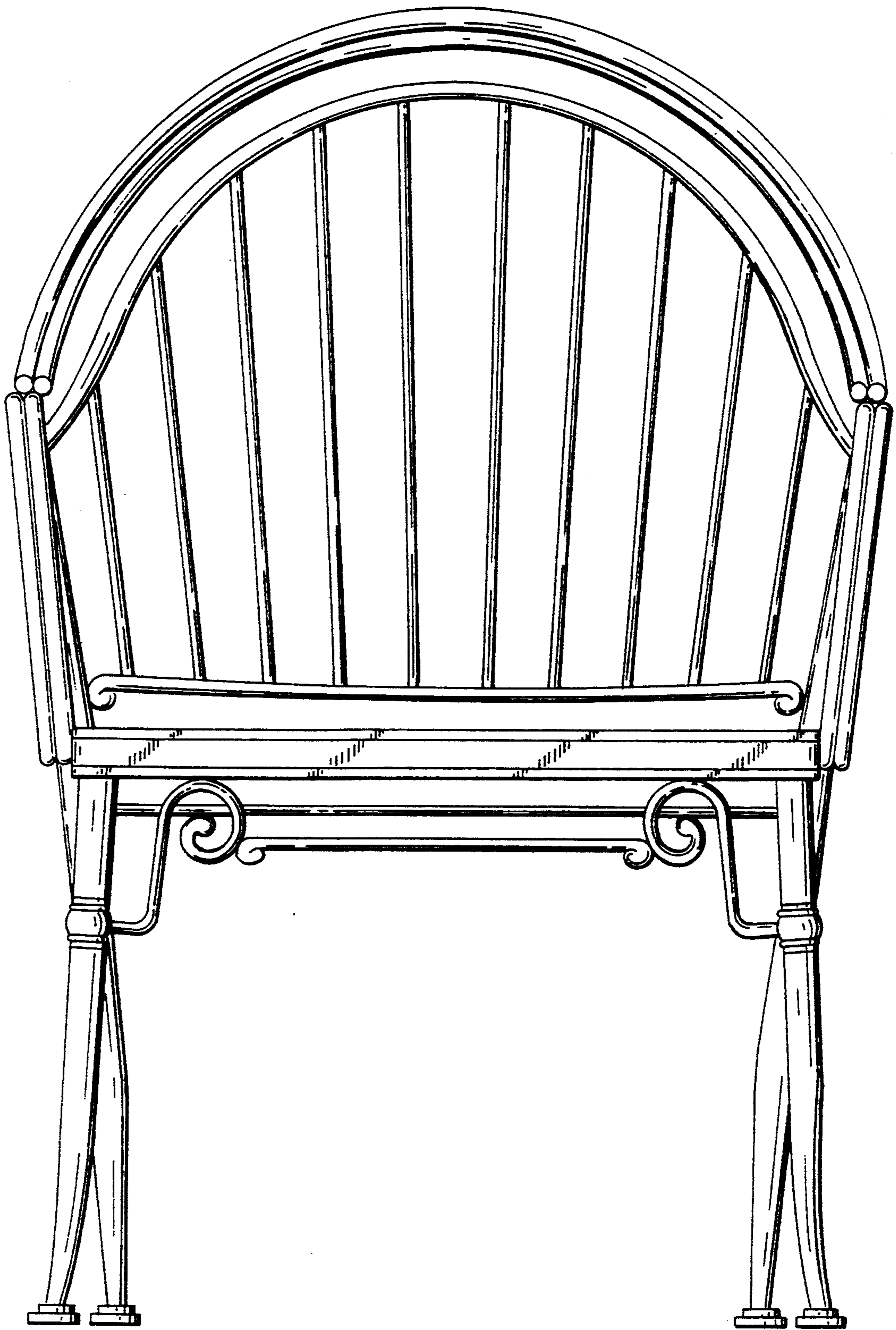

FIG-6

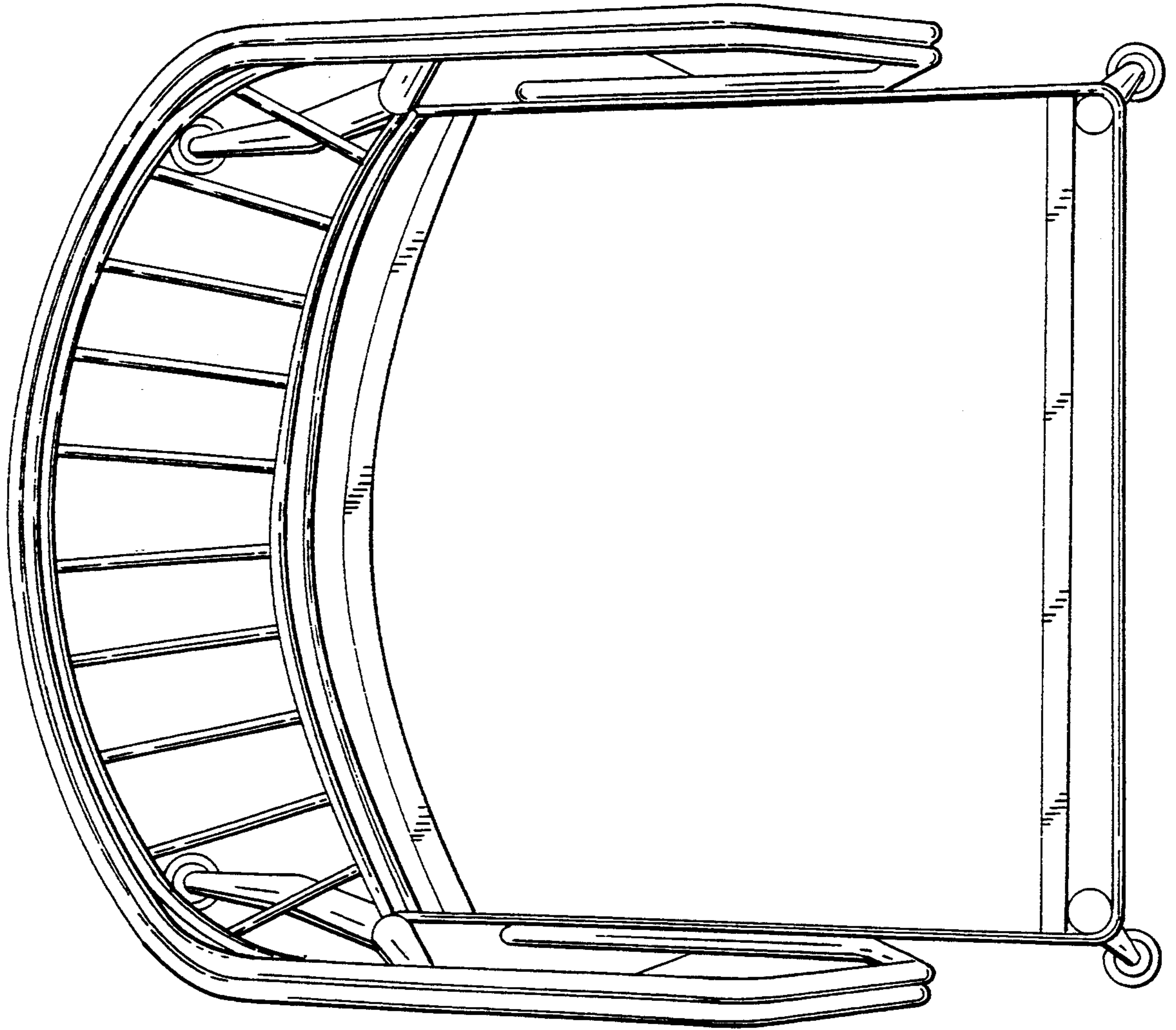

FIG-7

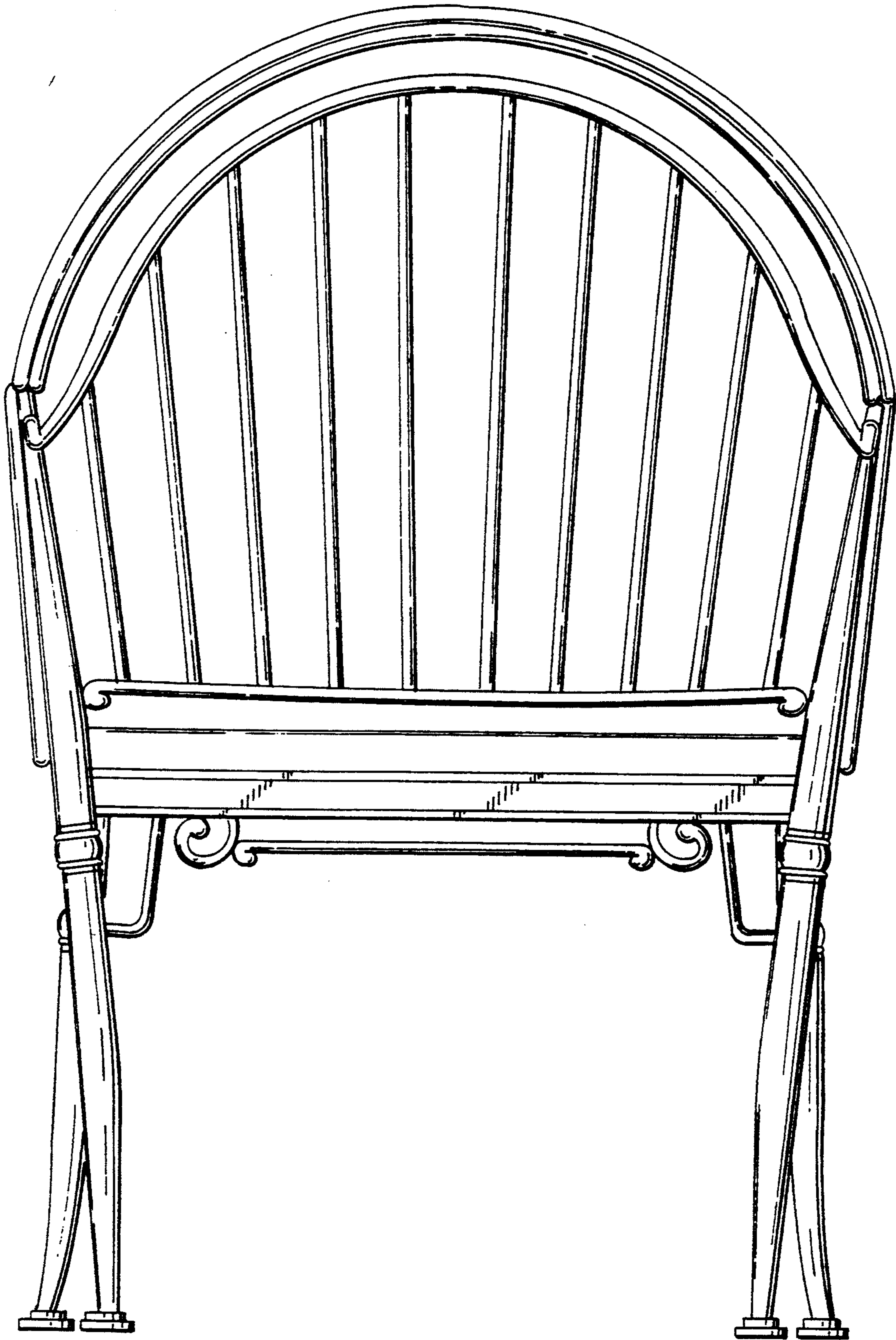

FIG-8